

P-C3562DN

P-C4072DN

Operation Guide

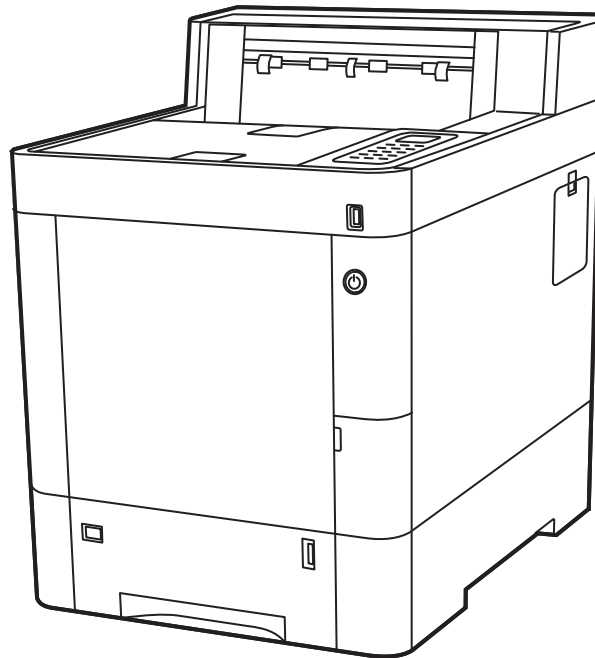

Preface

Thank you for purchasing this machine.

This Operation Guide is intended to help you operate the machine correctly, perform routine maintenance, and take simple troubleshooting measures as needed so that the machine can always be used in the optimum condition.

Please read this Operation Guide before using the machine.

To maintain quality, we recommend using genuine own brand toner containers, which must pass numerous quality inspections.

The use of non-genuine toner containers may cause failure.

We will not be liable for any damages caused by the use of third party supplies in this machine.

Checking the Equipment's Serial Number

The equipment's serial number is printed in the location shown in the figure.

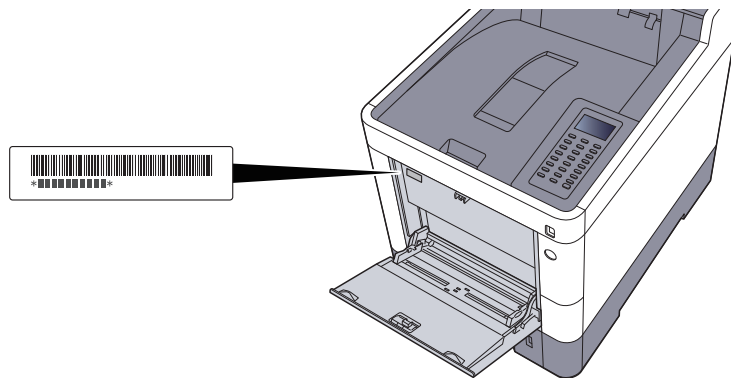

You'll need the equipment's serial number when contacting your Service Representative. Please check the number before contacting your Service Representative

Contents

Preface	i
Contents	ii
Machine Features	vi
Guides Provided with the Machine	viii
About the Operation Guide (this Guide)	x
Structure of the guide	x
Conventions Used in This Guide	xi
Menu Map	xiii

1 Legal and Safety Information 1-1

Notice	1-2
Safety Conventions in This Guide	1-2
Environment	1-3
Precautions for Use	1-4
Laser Safety (Europe)	1-5
Compliance and Conformity	1-5
EN ISO 7779	1-5
EK1-ITB 2000	1-5
Wireless Connection (Mexico only)	1-5
Security Precautions when Using Wireless LAN (If equipped)	1-6
Limited Use of This Product (If equipped)	1-7
Legal Information	1-8
Energy Saving Control Function	1-12
Automatic 2-Sided Print Function	1-12
Resource Saving - Paper	1-12
Environmental benefits of "Power Management"	1-12
Energy Star (ENERGY STAR®) Program	1-12

2 Installing and Setting up the Machine 2-1

Part Names	2-2
Machine Exterior	2-2
Connectors/Interior	2-3
With Optional Equipments Attached	2-5
Connecting the Machine and Other Devices	2-6
Connecting Cables	2-7
Connecting LAN Cable	2-7
Connecting USB Cable	2-8
Connecting the Power Cable	2-8
Power On/Off	2-9
Power On	2-9
Power Off	2-9
Using the Operation Panel	2-10
Operation Panel Keys	2-10
Operation Method	2-11
Help Screen	2-12
Login/Logout	2-13
Login	2-13
Logout	2-14
Default Settings of the Machine	2-15
Setting Date and Time	2-15
Network Setup	2-16
Configuring the Wired Network	2-16
Configuring the Wireless Network	2-18
Setting Wi-Fi Direct	2-22
Energy Saver function	2-24
Sleep and Auto Sleep	2-24

	Power Off Rule (models for Europe)	2-25
	Installing Software	2-26
	Software on DVD (Windows)	2-26
	Installing Software in Windows	2-27
	Uninstalling the Software	2-33
	Installing Software in Mac Computer	2-34
	Checking the Counter	2-36
	Additional Preparations for the Administrator	2-37
	Strengthening the Security	2-37
	Embedded Web Server RX	2-38
	Accessing Embedded Web Server RX	2-39
	Changing Security Settings	2-40
	Changing Device Information	2-42
	E-mail Settings	2-44
	Creating a New Custom Box	2-48
	Printing a document stored in a Custom Box	2-49
3	Preparation before Use	3-1
	Loading Paper	3-2
	Precaution for Loading Paper	3-3
	Loading in the Cassettes	3-4
	Loading Paper in the Multi Purpose Tray	3-7
	Specifying Paper Size and Media Type	3-10
	Paper Stopper	3-13
4	Printing from PC	4-1
	Printing from PC	4-2
	Printing on Non-standard Sized Paper	4-4
	Printer Driver Print Settings Screen	4-5
	Printer Driver Help	4-6
	Changing the Default Printer Driver Settings (Windows 8.1)	4-6
	Canceling Printing from a Computer	4-6
	Printing by AirPrint	4-7
	Printing by Google Cloud Print	4-7
	Printing by Mopria	4-7
	Printing with Wi-Fi Direct	4-7
	Printing Data Saved on the Printer	4-8
	Specifying the Job Box from a Computer and Storing the Job	4-8
	Printing Documents from Private Print Box	4-9
	Printing Document from Stored Job Box	4-11
	Printing Document from Quick Copy Box	4-13
	Printing Document from Proof and Hold Box	4-15
	Job Box Setting	4-17
	Status Monitor	4-18
	Accessing the Status Monitor	4-18
	Exiting the Status Monitor	4-18
	Status Monitor Display	4-18
5	Operation on the Machine	5-1
	Canceling Jobs	5-2
	What is Document Box?	5-3
	Using a Custom Box	5-5
	Creating a New Custom Box	5-5
	Editing and Deleting Custom Box	5-7
	Storing Documents	5-7
	Printing Documents	5-8
	Editing Documents	5-9

	Deleting Documents	5-10
	Printing Documents Stored in Removable USB Memory	5-11
	Removing USB Memory	5-13
6	Using Various Functions	6-1
	Functions Available on the Machine	6-2
	Custom Box (Printing)	6-2
	Removable Memory (Printing Documents)	6-3
	Functions	6-4
	EcoPrint	6-4
	Duplex	6-4
	Job Finish Notice	6-4
	File Name Entry	6-5
	Quiet Mode	6-5
	Del. after Print (Delete after Printed)	6-5
	Encrypted PDF	6-5
	TIFF/JPEG Size	6-6
	XPS FitTo Page	6-6
7	Status/Job Cancel	7-1
	Checking Job Status	7-2
	Checking Job History	7-3
	Sending the Log History	7-4
	Device/Communication	7-5
	Checking the Remaining Amount of Toner and Paper (Paper/Supplies)	7-6
8	Setup and Registration (System Menu)	8-1
	System Menu	8-2
	Menu Settings	8-3
	Report	8-5
	Paper Settings	8-7
	Print Settings	8-10
	Network	8-12
	Optional Network	8-22
	Device Common	8-25
	Security	8-31
	User/Job Account	8-33
	Adjust/Maint.	8-34
	Op Functions	8-34
	Software	8-34
9	User Authentication and Accounting (User Login, Job Accounting)	9-1
	Overview of User Login Administration	9-2
	Enabling User Login Administration	9-3
	Setting User Login Administration	9-5
	Adding a User (Local User List)	9-5
	Changing User Properties	9-6
	User Login Administration for Printing	9-8
	NW User Property (Obtain Network User Property)	9-10
	ID Card Settings	9-11
	PIN Login Settings	9-12
	Using User Login Administration	9-13
	Login/Logout	9-13
	Overview of Job Accounting	9-14
	Enabling Job Accounting	9-15
	Job Accounting Access	9-16



	Setting an Account	9-17
	Adding an Account	9-17
	Restricting the Use of the Machine	9-18
	Editing an Account	9-19
	Deleting an Account	9-20
	Job Accounting for Printing	9-21
	Configuring Job Accounting	9-23
	Apply Limit	9-23
	Counting the Number of Pages Printed	9-24
	Print Accounting Report	9-25
	Using Job Accounting	9-26
	Login/Logout	9-26
	Unknown ID Job	9-27
10	Troubleshooting	10-1
	Regular Maintenance	10-2
	Cleaning	10-2
	Toner Container Replacement	10-3
	Waste Toner Box Replacement	10-7
	Troubleshooting	10-9
	Solving Malfunctions	10-9
	Responding to Messages	10-13
	Adjustment/Maintenance	10-20
	Clearing Paper Jams	10-25
11	Appendix	11-1
	Optional Equipment	11-2
	Overview of Optional Equipment	11-2
	Optional Applications	11-8
	Character Entry Method	11-10
	Using the Keys	11-10
	Selecting Type of Characters	11-11
	Characters That Can be Entered Using the Numeric Keys	11-11
	Entering Symbols	11-12
	Entering Characters	11-12
	Paper	11-14
	Basic Paper Specifications	11-14
	Choosing the Appropriate Paper	11-15
	Special Paper	11-18
	Specifications	11-22
	Machine	11-22
	Printer Functions	11-24
	Paper Feeder (500-sheet) (Option)	11-24
	Glossary	11-25
	Index	Index-1

Machine Features

The machine is equipped with many useful functions.

➔ [Using Various Functions \(page 6-1\)](#)

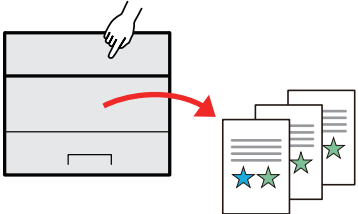
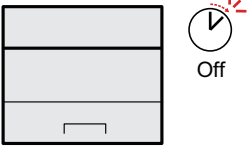
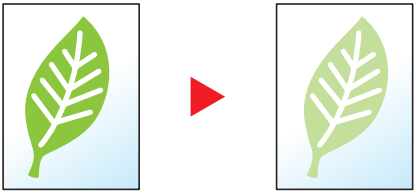
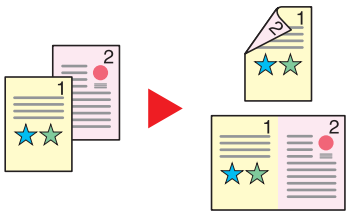
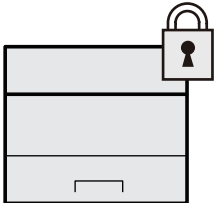
Here are some examples.

Optimize your office workflow	Save energy and cost	
<p>Save frequently used documents in the machine (Custom Box)</p>  <p>You can save the frequently used document in the machine and print it when needed.</p> <p>➔ Using a Custom Box (page 5-5)</p>	<p>Save energy as needed (Energy Saver function)</p>  <p>The machine is equipped with Energy Saver function that automatically switched into Sleep Mode.</p> <p>➔ Energy Saver function (page 2-24)</p>	<p>Use less toner for printing (EcoPrint)</p>  <p>You can save toner consumption with this function.</p> <p>When you only need to check the printed content, such as a trial print run or documents for internal confirmation, use this function to save toner.</p> <p>Use this function when a high-quality print is not required.</p> <p>➔ EcoPrint (page 6-4)</p>
Save energy and cost	Strengthen security	
<p>Reduce paper use (Paper Saving Printing)</p>  <p>You can print originals on both sides of the paper. You can also print multiple originals onto one sheet.</p> <p>➔ Duplex (page 6-4)</p>	<p>Protect data on the SSD (Encryption / Overwrite)</p>  <p>You can overwrite the unnecessary data that remains on the SSD automatically. To prevent an external leakage, the machine is able to encrypt data before writing it to the SSD.</p> <p>➔ Data Security (page 8-32)</p>	<p>Prevent loss of finished documents (Private Print)</p>  <p>You can temporarily save a printer document in the machine. By printing the document from the machine prevents someone takes your document.</p> <p>➔ Printing Data Saved on the Printer (page 4-8)</p>

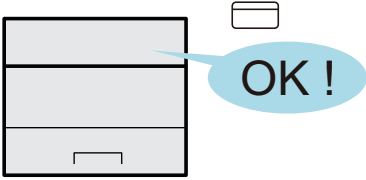
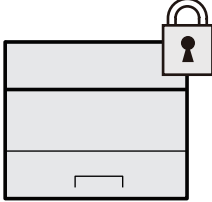
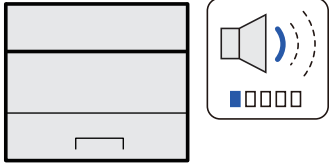
Strengthen security		Use functions more efficiently
<p>Log in by ID card (Card Authentication)</p>  <p>You can log in simply by touching an ID card. You don't need to enter your user name and password.</p> <p>➔ Card Authentication Kit(B) "Card Authentication Kit" (page 11-3)</p>	<p>Strengthen security (Settings for Administrator)</p>  <p>Various functions are available for administrators to strengthen security.</p> <p>➔ Strengthening the Security (page 2-37)</p>	<p>Make the machine quiet (Quiet Mode)</p>  <p>You can make the machine quiet by reducing its running noise. You can configure this mode by job.</p> <p>➔ Quiet Mode (page 6-5)</p>

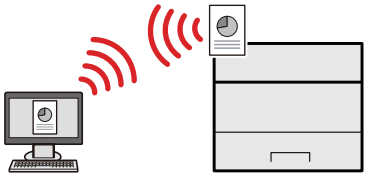
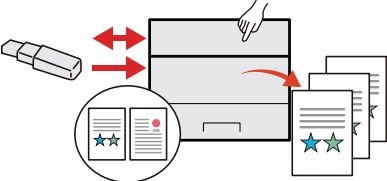
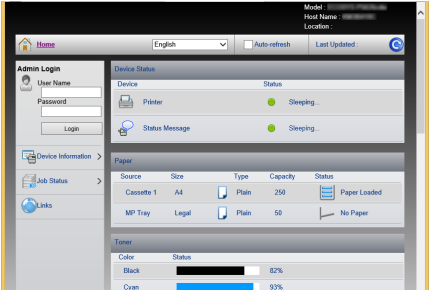
Use functions more efficiently		
<p>Install the machine without concerning the network cables (Wireless Network)</p>  <p>In an environment where the wireless LAN is used, you can install the machine without concerning the network cables. In addition, Wi-Fi Direct, etc. are supported.</p> <p>➔ Configuring the Wireless Network (page 2-18)</p> <p>➔ Setting Wi-Fi Direct (page 2-22)</p>	<p>Use USB memory (USB Memory)</p>  <p>It is useful when you need to print document outside your office or you cannot print document from your PC. You can print the document from the USB memory by plugging it directly into the machine.</p> <p>➔ Printing Documents Stored in Removable USB Memory (page 5-11)</p>	<p>Perform remote operation (Embedded Web Server RX)</p>  <p>You can access to the machine remotely to print, send or download data. Administrators can configure the machine behavior or management settings.</p> <p>➔ Embedded Web Server RX (page 2-38)</p>

Guides Provided with the Machine

The following guides are provided with the machine. Refer to each guide as needed.

The contents of the guides are subject to change without notice for the purpose of improvement of machine performance.

Printed guides

Start using the machine quickly



Quick Guide

Explains how to use basic functions of the machine, how to use convenient features, how to perform routine maintenance, and what to do when problems occur.

For safe use of the machine











Safety Guide

Provides safety and cautionary information for installation environment and use of the machine. Be sure to read this guide before using the machine.

Safety Guide (P-C3562DN/P-C4072DN)

Indicates the space required for machine installation, and describes the cautionary labels and other safety information. Be sure to read this guide before using the machine.

Guides (PDF) on the DVD (Product Library)

Use the machine thoughtfully	 Operation Guide (This Guide) Explains how to load paper and perform basic operations, and indicates default settings and other information.
Use the ID card	 Card Authentication Kit (B) Operation Guide Explains how to perform authentication using the ID card.
Strengthen security	 Data Security Kit (E) Operation Guide Explains how to introduce and use the Data Security kit (E), and how to overwrite and encrypt data.
Easily register machine information and configure settings	 Embedded Web Server RX User Guide Explains how to access the machine from a Web browser on your computer to check and change settings.
Print data from a computer	 Printing System Driver User Guide Explains how to install the printer driver and use the printer function.
Directly print a PDF file	 Network Tool for Direct Printing Operation Guide Explains how to print PDF files without launching Adobe Acrobat or Reader.
Monitor the machine and printers on the network	 NETWORK PRINT MONITOR User Guide Explains how to monitor your network printing system (the machine) with NETWORK PRINT MONITOR.
Print without using the printer driver	 PRESCRIBE Commands Command Reference Describes the native printer language (PRESCRIBE commands).
	PRESCRIBE Commands Technical Reference Describes the PRESCRIBE command functions and control for each type of emulation.
Adjust the print position	 Maintenance Menu User Guide Maintenance Menu provides the explanation on how to configure the print settings.

Install the following versions of Adobe Reader to view the manuals on the DVD.
Version 8.0 or later

About the Operation Guide (this Guide)

Structure of the guide

The Operation Guide contains the following chapters.

Chapter		Contents
1	Legal and Safety Information	Provides precautions regarding use of the machine and trademark information.
2	Installing and Setting up the Machine	Explains part names, cable connections, installation of the software, login, logout, and other matters related to administration of the machine.
3	Preparation before Use	Explains preparations and settings that are required in order to use the machine, such as how to use the operation panel, and load paper.
4	Printing from PC	Explains the basic steps for printing.
5	Operation on the Machine	Explains the basic procedures for using document boxes.
6	Using Various Functions	Explains convenient functions that are available on the machine.
7	Status/Job Cancel	Explains how to check the status of a job and the job history, and how to cancel jobs being printed or waiting to print. Also explains how to check paper and toner levels, and how to check the device status.
8	Setup and Registration (System Menu)	Explains System Menu and how it relates to the operation of the machine.
9	User Authentication and Accounting (User Login, Job Accounting)	Explains user login and job accounting.
10	Troubleshooting	Explains what to do when toner runs out, an error is displayed, or a paper jam or other problem occurs.
11	Appendix	Describes convenient options that are available for the machine. Provides information on media types and paper sizes, and gives a glossary of terms. Explains how to enter characters, and lists the specifications of the machine.

Conventions Used in This Guide

Adobe Reader XI is used as an example in the explanations below.

Click an item in the Table of Contents to jump to the corresponding page.

Click to move from the current page to the previously displayed page. This is convenient when you want to return to the page from which you jumped to the current page.

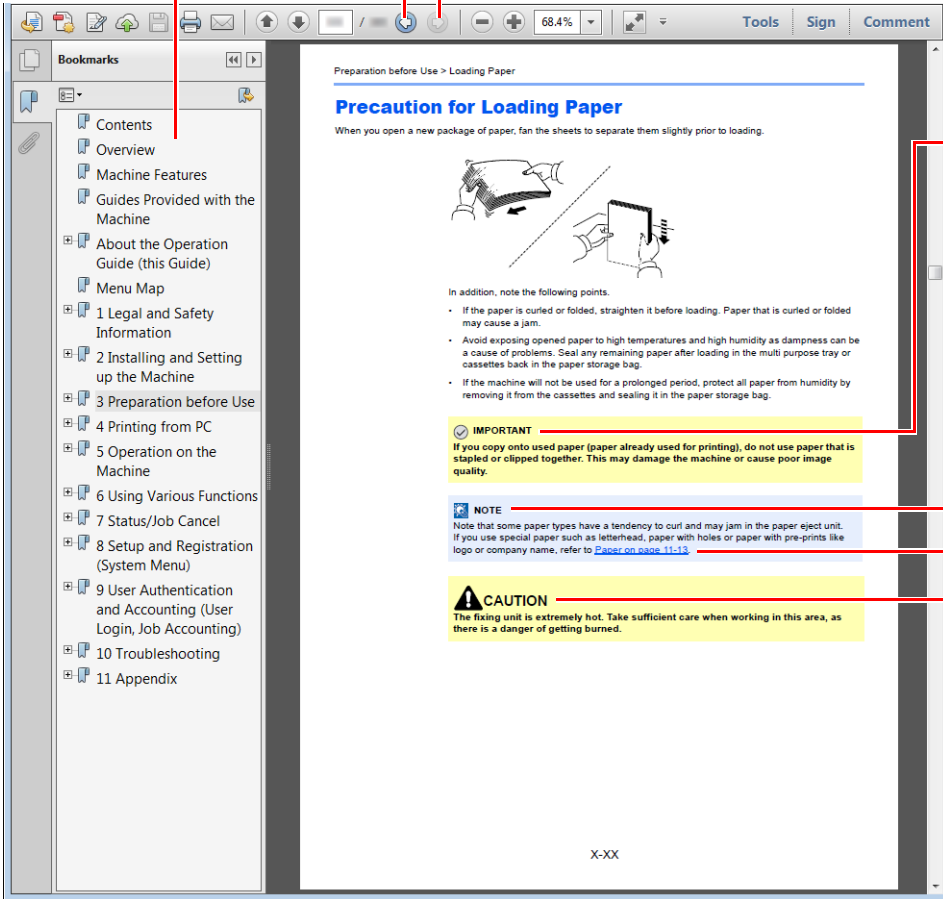

 **IMPORTANT**
Indicates operational requirements and restrictions to operate the machine correctly, and avoid damage to the machine or property.

 **NOTE**
Indicates supplemental explanations and reference information for operations.

Refer to
Click the underlined text to jump to the corresponding page.

 **CAUTION**
Indicates that personal injury or mechanical damage may result from insufficient attention to or incorrect compliance with the related points.

 **NOTE**

The items that appear in Adobe Reader vary depending on how it is used. If the Table of Contents or tools do not appear, refer to Adobe Reader Help.

Certain items are indicated in this guide by the conventions described below.

Convention	Description
[Bold]	Indicates keys and buttons.
"Regular"	Indicates a message or setting.





Conventions used in procedures for operating the machine

In this Operation Guide, continuous operation is as follows:

Actual procedure	Procedure indicated in this guide
Select the [Menu] key. ▼ Select the [▲] or [▼] key to select [Device Common] . ▼ Select the [OK] key.	[Menu] key > [▲] [▼] key > [Device Common] > [OK] key

Menu Map

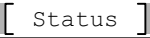
This is a list of menus displayed on the message display. Depending on the settings, some menus may not be displayed. Some menu names may differ from their reference titles.

		Custom Box	(Box Selection)	(File Selection)	Print		
					Print (Change Set)	Function	Quiet Mode (page 6-5)
							Duplex (page 6-4)
							EcoPrint (page 6-4)
							File Name Entry (page 6-5)
							JobFinish Notice (page 6-4)
							Del. after Print (page 6-5)
					Delete		
					Move		
					Job Box	Quick Copy (page 4-13)	
Private/Stored (page 4-9)							
Job Box Setting (page 4-17)							
		Job Status (page 7-2)					
		Job Log (page 7-3)					
		Keyboard (page 7-5)					
		Network (page 7-5)					
		Wi-Fi (page 7-5)					
		Wi-Fi Direct (page 7-5)					
		Option Network (page 7-5)					

Menu



Report	Report Print	Menu Map (page 8-5)
		Config. List (page 8-5)
		Status Page (page 8-5)
		Font List (page 8-6)
		RAM File List (page 8-6)
		SSD File List (page 8-6)
		SD Card FileList (page 8-6)
		DataSanitization (page 8-6)
	Job Log History	Auto Sending (page 8-6)
		Send History (page 8-6)
		Destination (page 8-6)
		Subject (page 8-6)
		Personal Info. (page 8-6)
USB Memory	Print File (page 5-11)	
	Remove Memory (page 5-13)	
Counter (page 2-36)		
Paper Settings	MP Tray Set.	Paper Size (page 8-7)
		Media Type (page 8-7)
	Cassette 1 Set.	Media Type (page 8-8)
		Other Paper Size (page 8-8)
		Custom PaperSize (page 8-8)
	Cassette 2 Set.	Media Type (page 8-8)
		Other Paper Size (page 8-8)
		Custom PaperSize (page 8-8)
	Cassette 3 Set.	Media Type (page 8-8)
		Other Paper Size (page 8-8)
		Custom PaperSize (page 8-8)
	Cassette 4 Set.	Media Type (page 8-8)
		Other Paper Size (page 8-8)
		Custom PaperSize (page 8-8)
		Media Type Set. (page 8-7)
		Reset Type Adj. (page 8-7)

Paper Settings	Paper Setup Msg	MP Tray (page 8-7)	
		Cassette 1 (page 8-7)	
		Cassette 2 (page 8-7)	
		Cassette 3 (page 8-7)	
		Cassette 4 (page 8-7)	
Print Settings	Paper Source (page 8-10)		
	Auto Cass.Change (page 8-10)		
	MP Tray Priority (page 8-10)		
	Paper Feed Mode (page 8-10)		
	Duplex (page 8-10)		
	Override A4/LTR (page 8-10)		
	Emulation Set. (page 8-10)		
	Color Mode (page 8-10)		
	Print Quality	KIR (page 8-11)	
		EcoPrint (page 8-11)	
		EcoPrint SaveLvl (page 8-11)	
		Gloss Mode (page 8-11)	
		Print Resolution (page 8-11)	
	Page Setting	Copies (page 8-11)	
		Orientation (page 8-11)	
		LF Action (page 8-11)	
		CR Action (page 8-11)	
		Wide A4 (page 8-11)	
		XPS FitTo Page (page 8-11)	
		TIFF/JPEG Size (page 8-11)	
	User Name (page 8-11)		
Job Name (page 8-12)			
Job Terminator (page 8-12)			

Network	Host Name (page 8-12)	
	Wi-Fi Direct Set	Wi-Fi Direct (page 8-12)
		Device Name (page 8-12)
		IP Address (page 8-12)
		Auto Disconnect (page 8-13)
	Wi-Fi Settings	Wi-Fi (page 8-13)
		Setup (page 8-13)
		TCP/IP Settings (page 8-14)
		Restart Network (page 8-15)
	Wired Netwk. Set	TCP/IP Settings (page 8-15)
		LAN Interface (page 8-15)
	ProtocolSettings (page 8-16)	
	Primary Network (page 8-21)	
Ping (page 8-21)		
Restart Network (page 8-22)		
Optional Network	Wireless Network (page 8-22)	
	Basic (page 8-24)	

Device Common	Language (page 8-25)
	Def. Screen(Box) (page 8-25)
	Date Setting
	Date (page 8-25)
	Time (page 8-25)
	Date Format (page 8-25)
	Time Zone (page 8-25)
	Summer Time (page 8-25)
	Buzzer
	Key Confirmation (page 8-26)
	Job Finish (page 8-26)
	Ready (page 8-26)
	Error (page 8-26)
	Keyboard Confirm (page 8-26)
	RAM Disk Setting (page 8-26)
	Format SSD (page 8-26)
	Format SD Card (page 8-27)
	Display Bright. (page 8-27)
	Error Handling
	DuplexPaperError (page 8-27)
	Paper Mismatch (page 8-27)
	MP Tray Empty (page 8-27)
	ColorToner Empty (page 8-27)
	Timer Setting
	Auto Panel Reset (page 8-28)
	PanelReset Timer (page 8-28)
	Sleep Level Set. (page 8-28)
	Sleep Timer (page 8-28)
	Power Off Rule (page 8-29)
	Power Off Timer (page 8-29)
	WeeklyTimer Set. (page 8-29)
Auto Err. Clear (page 8-29)	
Err. Clear Timer (page 8-29)	
FormFeed TimeOut (page 8-30)	
Ping Timeout (page 8-30)	
Disp. Status/Log (page 8-30)	
USB KeyboardType (page 8-30)	
Bluetooth Set. (page 8-30)	
Low Toner Alert (page 8-30)	

Security	Network Security (page 8-31)		
	I/F Block Set. (page 8-31)		
	Security Level (page 8-31)		
	Data Security (page 8-32)		
User/Job Account	User Login Set.	User Login (page 9-3)	
		Local User List (page 9-5)	
		ID Card Settings	Key Login (page 9-11)
			Additional Auth. (page 9-11)
		PIN Login (page 9-12)	
		NW User Property (page 9-10)	
	Job Account.Set.	Job Accounting (page 9-15)	
		AccountingAccess (page 9-16)	
		Account. (Local) (page 9-16)	
		Apply Limit (page 9-23)	
	Unknown ID Job (page 9-27)		
Adjust/Maint.	Quiet Mode (page 8-34)		
	ColorCalibration (page 8-34)		
	Color Regist. (page 8-34)		
	Restart (page 8-34)		
	Service Setting (page 8-34)		
Op Functions (page 8-34)			
Software (page 8-34)			

1 Legal and Safety Information

Please read this information before using your machine. This chapter provides information on the following topics.

Notice	1-2
Safety Conventions in This Guide	1-2
Environment	1-3
Precautions for Use	1-4
Laser Safety (Europe)	1-5
Compliance and Conformity	1-5
EN ISO 7779	1-5
EK1-ITB 2000	1-5
Wireless Connection (Mexico only)	1-5
Security Precautions when Using Wireless LAN (If equipped)	1-6
Limited Use of This Product (If equipped)	1-7
Legal Information	1-8
Energy Saving Control Function	1-12
Automatic 2-Sided Print Function	1-12
Resource Saving - Paper	1-12
Environmental benefits of "Power Management"	1-12
Energy Star (ENERGY STAR®) Program	1-12

Notice

Safety Conventions in This Guide

The sections of this guide and parts of the machine marked with symbols are safety warnings meant to protect the user, other individuals and surrounding objects, and ensure correct and safe usage of the machine. The symbols and their meanings are indicated below.

 **WARNING:** Indicates that serious injury or even death may result from insufficient attention to or incorrect compliance with the related points.

 **CAUTION:** Indicates that personal injury or mechanical damage may result from insufficient attention to or incorrect compliance with the related points.

Symbols

The  symbol indicates that the related section includes safety warnings. Specific points of attention are indicated inside the symbol.

 ... [General warning]

 ... [Warning of high temperature]

The  symbol indicates that the related section includes information on prohibited actions. Specifics of the prohibited action are indicated inside the symbol.

 ... [Warning of prohibited action]

 ... [Disassembly prohibited]

The  symbol indicates that the related section includes information on actions which must be performed. Specifics of the required action are indicated inside the symbol.

 ... [Alert of required action]

 ... [Remove the power plug from the outlet]

 ... [Always connect the machine to an outlet with a ground connection]

Please contact your service representative to order a replacement if the safety warnings in this Operation Guide are illegible or if the guide itself is missing (fee required).

Environment

The service environmental conditions are as follows:

Temperature	50 to 90.5 °F (10 to 32.5 °C)
Humidity	10 to 80%

Avoid the following locations when selecting a site for the machine.

- Avoid locations near a window or with exposure to direct sunlight.
- Avoid locations with vibrations.
- Avoid locations with drastic temperature fluctuations.
- Avoid locations with direct exposure to hot or cold air.
- Avoid poorly ventilated locations.

If the floor is delicate against casters, when this machine is moved after installation, the floor material may be damaged.

During printing, some ozone is released, but the amount does not cause any ill effect to one's health. If, however, the machine is used over a long period of time in a poorly ventilated room or when making an extremely large number of prints, the smell may become unpleasant. To maintain the appropriate environment for print work, it is suggested that the room be properly ventilated.

Precautions for Use

Cautions when handling consumables

CAUTION

Do not attempt to incinerate parts which contain toner. Dangerous sparks may cause burns.

Keep parts which contain toner out of the reach of children.

If toner happens to spill from parts which contain toner, avoid inhalation and ingestion, as well as contact with your eyes and skin.

- If you do happen to inhale toner, move to a place with fresh air and gargle thoroughly with a large amount of water. If coughing develops, contact a physician.
- If you do happen to ingest toner, rinse your mouth with water and drink 1 or 2 cups of water to dilute the contents of your stomach. If necessary, contact a physician.
- If you do happen to get toner in your eyes, flush them thoroughly with water. If there is any remaining tenderness, contact a physician.
- If toner does happen to get on your skin, wash with soap and water.

Do not attempt to force open or destroy parts which contain toner.

Other precautions

Return the exhausted toner container and waste toner box to your dealer or service representative. The collected toner container and waste toner box will be recycled or disposed in accordance with the relevant regulations.

Store the machine while avoiding exposure to direct sunlight.

Store the machine in a place where the temperature stays below 40 °C while avoiding sharp changes of temperature and humidity.

If the machine will not be used for an extended period of time, remove the paper from the cassette and the Multi Purpose (MP) Tray, return it to its original package and reseal it.

Laser Safety (Europe)

Laser radiation could be hazardous to the human body. For this reason, laser radiation emitted inside this machine is hermetically sealed within the protective housing and external cover. In the normal operation of the product by user, no radiation can leak from the machine.

This machine is classified as Class 1 laser product under IEC/EN 60825-1:2014.

Regarding CLASS 1 laser products, information is provided on the rating label.



Compliance and Conformity

Hereby, TA Triumph-Adler GmbH declares that the radio equipment type P-C3562DN/P-C4072DN are in compliance with Directive 2014/53/EU.

The full text of the EU declaration of conformity is available at the following internet address:

<http://www.triumph-adler.com/downloads>

<http://www.triumph-adler.de/downloads>

<http://www.utax.com/downloads>

<http://www.utax.de/downloads>

Module name	Software Ver.	Frequency band in which the radio equipment operates:	Maximum radio-frequency power transmitted in the frequency band in which the radio equipment operates:
IB-51 (Option)	2.2.6	2.4GHz	100mW
IB-36 (Option)	2014.12	2.4GHz	100mW

EN ISO 7779

Maschinenlärminformations-Verordnung 3. GPSGV, 06.01.2004: Der höchste Schalldruckpegel beträgt 70 dB (A) oder weniger gemäß EN ISO 7779.

EK1-ITB 2000

Das Gerät ist nicht für die Benutzung im unmittelbaren Gesichtsfeld am Bildschirmarbeitsplatz vorgesehen. Um störende Reflexionen am Bildschirmarbeitsplatz zu vermeiden, darf dieses Produkt nicht im unmittelbaren Gesichtsfeld platziert werden.

Wireless Connection (Mexico only)

The operation of this equipment is subject to the following two conditions:

(1) it is possible that this equipment or device may not cause harmful interference, and (2) this equipment or device must accept any interference, including interference that may cause undesired operation.

La operación de este equipo está sujeta a las siguientes dos condiciones:

(1) es posible que este equipo o dispositivo no cause interferencia perjudicial y (2) este equipo o dispositivo debe aceptar cualquier interferencia, incluyendo la que pueda causar su operación no deseada.

Security Precautions when Using Wireless LAN (If equipped)

Wireless LAN allows information to be exchanged between wireless access points instead of using a network cable, which offers the advantage that a LAN connection can be established freely within an area in which radio waves can be transmitted.

On the other hand, the following problems may occur if security settings are not configured, because radio waves can pass through obstacles (including walls) and reach everywhere within a certain area.

Secretly Viewing Communication Contents

A third person with malicious objectives may intentionally monitor radio waves and gain unauthorized access to the following communication contents.

- Personal information including ID, passwords, and credit card numbers
- Contents of email messages

Illegal Intrusion

A third party with malicious intent may gain unauthorized access to personal or company networks and conduct the following illegal actions.

- Extracting personal and confidential information (information leak)
- Entering into communication while impersonating a specific person and distributing unauthorized information (spoofing)
- Modifying and retransmitting intercepted communications (falsification)
- Transmitting computer viruses and destroying data and systems (destruction)

Wireless LAN cards and wireless access points contain built-in security mechanisms to address these problems and to reduce the possibility of these problems occurring by configuring the security settings of wireless LAN products when the product is used.

We recommend that customers take responsibility and use their judgment when configuring the security settings and that they ensure that they fully understand the problems that can occur when the product is used without configuring the security settings.

Limited Use of This Product (If equipped)

- Radio waves transmitted from this product may affect medical equipment. When using this product in a medical institution or in the vicinity of medical instruments, either use this product according to the instructions and precautions provided by the administrator of the institution or those provided on the medical instruments.
- Radio waves transmitted from this product may affect automatic control equipment including automatic doors and fire alarms. When using this product in the vicinity of the automatic control equipment, use this product according to the instructions and precautions provided on the automatic control equipment.
- If this product is used in devices that are directly related to service including airplanes, trains, ships, and automobiles or this product is used in applications requiring high reliability and safety to function and in devices requiring accuracy including those used in disaster prevention and crime prevention and those used for various safety purposes, please use this product after considering the safety design of the entire system including adoption of a failsafe design and redundancy design for reliability and safety maintenance of the entire system. This product is not intended for use in applications requiring high reliability and safety including aerospace instruments, trunk communication equipment, nuclear power control equipment, and medical equipment; hence, the decision as to whether to use this product in these applications needs to be fully considered and determined.

Sólo México (Mexico only)

Este equipo utiliza el módulo de interfaz de red inalámbrica modelo LBWA1ZZ1CA para conectarse a las redes Inalámbricas.

Legal Information

Copying or other reproduction of all or part of this guide without the prior written consent of Copyright owner is prohibited.

Regarding Trade Names

- PRESCRIBE is a registered trademark of Kyocera Corporation.
- KPDL is a trademark of Kyocera Corporation.
- Microsoft, Windows, Windows Vista, Windows Server and Internet Explorer are registered trademarks or trademarks of Microsoft Corporation in the U.S.A. and/or other countries.
- PCL is a trademark of Hewlett-Packard Company.
- Adobe Acrobat, Adobe Reader and PostScript are trademarks of Adobe Systems, Incorporated.
- Ethernet is a registered trademark of Xerox Corporation.
- Novell and NetWare are registered trademarks of Novell, Inc.
- IBM and IBM PC/AT are trademarks of International Business Machines Corporation.
- AppleTalk, Bonjour, Macintosh, and Mac OS are trademarks of Apple Inc., registered in the U.S. and other countries.
- All European language fonts installed in this machine are used under licensing agreement with Monotype Imaging Inc.
- Helvetica, Palatino and Times are registered trademarks of Linotype GmbH.
- ITC Avant Garde Gothic, ITC Bookman, ITC ZapfChancery and ITC ZapfDingbats are registered trademarks of International Typeface Corporation.
- ThinPrint is a trademark of Cortado AG in Germany and other countries.
- UFST™ MicroType® fonts by Monotype Imaging Inc. are installed in this machine.
- This machine contains the software having modules developed by Independent JPEG Group.
- iPad, iPhone and iPod touch are trademarks of Apple Inc., registered in the U.S. and other countries.
- AirPrint and the AirPrint logo are trademarks of Apple Inc.
- iOS is a trademark or registered trademark of Cisco in the U.S. and other countries and is used under license by Apple Inc.
- Google and Google Cloud Print™ are trademarks and/or registered trademarks of Google Inc.
- Mopria™ is registered trademarks of Mopria™ Alliance.
- Wi-Fi and Wi-Fi Direct are trademarks and/or registered trademarks of Wi-Fi Alliance.

All other brands and product names are registered trademarks or trademarks of their respective companies. The designations ™ and ® will not be used in this Operation Guide.

GPL/LGPL

This product contains GPL (<http://www.gnu.org/licenses/gpl.html>) and/or LGPL (<http://www.gnu.org/licenses/lgpl.html>) software as part of its firmware. You can get the source code, and you are permitted to copy, redistribute and modify it under the terms of GPL/LGPL.

OpenSSL License

Copyright (c) 1998-2006 The OpenSSL Project. All rights reserved.

Redistribution and use in source and binary forms, with or without modification, are permitted provided that the following conditions are met:

1. Redistributions of source code must retain the above copyright notice, this list of conditions and the following disclaimer.
2. Redistributions in binary form must reproduce the above copyright notice, this list of conditions and the following disclaimer in the documentation and/or other materials provided with the distribution.
3. All advertising materials mentioning features or use of this software must display the following acknowledgment: "This product includes software developed by the OpenSSL Project for use in the OpenSSL Toolkit. (<http://www.openssl.org/>)"
4. The names "OpenSSL Toolkit" and "OpenSSL Project" must not be used to endorse or promote products derived from this software without prior written permission. For written permission, please contact openssl-core@openssl.org.
5. Products derived from this software may not be called "OpenSSL" nor may "OpenSSL" appear in their names without prior written permission of the OpenSSL Project.
6. Redistributions of any form whatsoever must retain the following acknowledgment: "This product includes software developed by the OpenSSL Project for use in the OpenSSL Toolkit (<http://www.openssl.org/>)"

THIS SOFTWARE IS PROVIDED BY THE OpenSSL PROJECT "AS IS" AND ANY EXPRESSED OR IMPLIED WARRANTIES, INCLUDING, BUT NOT LIMITED TO, THE IMPLIED WARRANTIES OF MERCHANTABILITY AND FITNESS FOR A PARTICULAR PURPOSE ARE DISCLAIMED. IN NO EVENT SHALL THE OpenSSL PROJECT OR ITS CONTRIBUTORS BE LIABLE FOR ANY DIRECT, INDIRECT, INCIDENTAL, SPECIAL, EXEMPLARY, OR CONSEQUENTIAL DAMAGES (INCLUDING, BUT NOT LIMITED TO, PROCUREMENT OF SUBSTITUTE GOODS OR SERVICES; LOSS OF USE, DATA, OR PROFITS; OR BUSINESS INTERRUPTION) HOWEVER CAUSED AND ON ANY THEORY OF LIABILITY, WHETHER IN CONTRACT, STRICT LIABILITY, OR TORT (INCLUDING NEGLIGENCE OR OTHERWISE) ARISING IN ANY WAY OUT OF THE USE OF THIS SOFTWARE, EVEN IF ADVISED OF THE POSSIBILITY OF SUCH DAMAGE.

Original SSLeay License

Copyright (C) 1995-1998 Eric Young (ey@cryptsoft.com) All rights reserved.

This package is an SSL implementation written by Eric Young (ey@cryptsoft.com). The implementation was written so as to conform with Netscapes SSL.

This library is free for commercial and non-commercial use as long as the following conditions are adhered to. The following conditions apply to all code found in this distribution, be it the RC4, RSA, lhash, DES, etc., code; not just the SSL code. The SSL documentation included with this distribution is covered by the same copyright terms except that the holder is Tim Hudson (tjh@cryptsoft.com).

Copyright remains Eric Young's, and as such any Copyright notices in the code are not to be removed.

If this package is used in a product, Eric Young should be given attribution as the author of the parts of the library used.

This can be in the form of a textual message at program startup or in documentation (online or textual) provided with the package.

Redistribution and use in source and binary forms, with or without modification, are permitted provided that the following conditions are met:

1. Redistributions of source code must retain the copyright notice, this list of conditions and the following disclaimer.
2. Redistributions in binary form must reproduce the above copyright notice, this list of conditions and the following disclaimer in the documentation and/or other materials provided with the distribution.
3. All advertising materials mentioning features or use of this software must display the following acknowledgement:
"This product includes cryptographic software written by Eric Young (eay@cryptsoft.com)"
The word 'cryptographic' can be left out if the routines from the library being used are not cryptographic related :-).
4. If you include any Windows specific code (or a derivative thereof) from the apps directory (application code) you must include an acknowledgement: "This product includes software written by Tim Hudson (tjh@cryptsoft.com)"

THIS SOFTWARE IS PROVIDED BY ERIC YOUNG "AS IS" AND ANY EXPRESS OR IMPLIED WARRANTIES, INCLUDING, BUT NOT LIMITED TO, THE IMPLIED WARRANTIES OF MERCHANTABILITY AND FITNESS FOR A PARTICULAR PURPOSE ARE DISCLAIMED. IN NO EVENT SHALL THE AUTHOR OR CONTRIBUTORS BE LIABLE FOR ANY DIRECT, INDIRECT, INCIDENTAL, SPECIAL, EXEMPLARY, OR CONSEQUENTIAL DAMAGES (INCLUDING, BUT NOT LIMITED TO, PROCUREMENT OF SUBSTITUTE GOODS OR SERVICES; LOSS OF USE, DATA, OR PROFITS; OR BUSINESS INTERRUPTION) HOWEVER CAUSED AND ON ANY THEORY OF LIABILITY, WHETHER IN CONTRACT, STRICT LIABILITY, OR TORT (INCLUDING NEGLIGENCE OR OTHERWISE) ARISING IN ANY WAY OUT OF THE USE OF THIS SOFTWARE, EVEN IF ADVISED OF THE POSSIBILITY OF SUCH DAMAGE.

The licence and distribution terms for any publically available version or derivative of this code cannot be changed. i.e. this code cannot simply be copied and put under another distribution licence [including the GNU Public Licence.]

Monotype Imaging License Agreement

- 1 *Software* shall mean the digitally encoded, machine readable, scalable outline data as encoded in a special format as well as the UFST Software.
- 2 You agree to accept a non-exclusive license to use the Software to reproduce and display weights, styles and versions of letters, numerals, characters and symbols (*Typefaces*) solely for your own customary business or personal purposes at the address stated on the registration card you return to Monotype Imaging. Under the terms of this License Agreement, you have the right to use the Fonts on up to three printers. If you need to have access to the fonts on more than three printers, you need to acquire a multiuser license agreement which can be obtained from Monotype Imaging. Monotype Imaging retains all rights, title and interest to the Software and Typefaces and no rights are granted to you other than a License to use the Software on the terms expressly set forth in this Agreement.
- 3 To protect proprietary rights of Monotype Imaging, you agree to maintain the Software and other proprietary information concerning the Typefaces in strict confidence and to establish reasonable procedures regulating access to and use of the Software and Typefaces.
- 4 You agree not to duplicate or copy the Software or Typefaces, except that you may make one backup copy. You agree that any such copy shall contain the same proprietary notices as those appearing on the original.
- 5 This License shall continue until the last use of the Software and Typefaces, unless sooner terminated. This License may be terminated by Monotype Imaging if you fail to comply with the terms of this License and such failure is not remedied within thirty (30) days after notice from Monotype Imaging. When this License expires or is terminated, you shall either return to Monotype Imaging or destroy all copies of the Software and Typefaces and documentation as requested.
- 6 You agree that you will not modify, alter, disassemble, decrypt, reverse engineer or decompile the Software.
- 7 Monotype Imaging warrants that for ninety (90) days after delivery, the Software will perform in accordance with Monotype Imaging-published specifications, and the diskette will be free from defects in material and workmanship. Monotype Imaging does not warrant that the Software is free from all bugs, errors and omissions.

The parties agree that all other warranties, expressed or implied, including warranties of fitness for a particular purpose and merchantability, are excluded.
- 8 Your exclusive remedy and the sole liability of Monotype Imaging in connection with the Software and Typefaces is repair or replacement of defective parts, upon their return to Monotype Imaging.

In no event will Monotype Imaging be liable for lost profits, lost data, or any other incidental or consequential damages, or any damages caused by abuse or misapplication of the Software and Typefaces.
- 9 Massachusetts U.S.A. law governs this Agreement.

- 10 You shall not sublicense, sell, lease, or otherwise transfer the Software and/or Typefaces without the prior written consent of Monotype Imaging.
- 11 Use, duplication or disclosure by the Government is subject to restrictions as set forth in the Rights in Technical Data and Computer Software clause at FAR 252-227-7013, subdivision (b)(3)(ii) or subparagraph (c)(1)(ii), as appropriate. Further use, duplication or disclosure is subject to restrictions applicable to restricted rights software as set forth in FAR 52.227-19 (c)(2).
- 12 You acknowledge that you have read this Agreement, understand it, and agree to be bound by its terms and conditions. Neither party shall be bound by any statement or representation not contained in this Agreement. No change in this Agreement is effective unless written and signed by properly authorized representatives of each party. By opening this diskette package, you agree to accept the terms and conditions of this Agreement.

Energy Saving Control Function

The device comes equipped with a **Sleep** where printer functions remain in a waiting state but power consumption is reduced to a minimum after a certain amount of time elapses since the device was last used.

Sleep

The device automatically enters Sleep when 1 minute has passed since the device was last used. The amount of time of no activity that must pass before Sleep is activated may be lengthened.

➔ [Sleep and Auto Sleep \(page 2-24\)](#)

Automatic 2-Sided Print Function

This device includes 2-sided printing as a standard function. For example, by printing two 1-sided originals onto a single sheet of paper as a 2-sided print, it is possible to lower the amount of paper used.

➔ [Duplex \(page 6-4\)](#)

Printing in duplex mode reduces paper consumption and contributes to the conservation of forest resources. Duplex mode also reduces the amount of paper that must be purchased, and thereby reduces cost. It is recommended that machines capable of duplex printing be set to use duplex mode by default.

Resource Saving - Paper

For the preservation and sustainable use of forest resources, it is recommended that recycled as well as virgin paper certified under environmental stewardship initiatives or carrying recognised ecolabels, which meet EN 12281:2002* or an equivalent quality standard, be used.

This machine also supports printing on 64 g/m² paper. Using such paper containing less raw materials can lead to further saving of forest resources.

* : EN12281:2002 "Printing and business paper - Requirements for copy paper for dry toner imaging processes"

Your sales or service representative can provide information about recommended paper types.

Environmental benefits of "Power Management"

To reduce power consumption when idle, this machine is equipped with a power management function that automatically activates energy-saving mode when the machine is idle for a certain period of time.

Although it takes the machine a slight amount of time to return to READY mode when in energy-saving mode, a significant reduction in energy consumption is possible. It is recommended that the machine be used with the activation time for energy-saving mode set to the default setting.

Energy Star (ENERGY STAR®) Program



We have determined as a participating company in the International Energy Star Program that this product is compliant with the standards laid out in the International Energy Star Program.

ENERGY STAR® is a voluntary energy efficiency program with the goal of developing and promoting the use of products with high energy efficiency in order to help prevent global warming. By purchasing

ENERGY STAR® qualified products, customers can help reduce emissions of greenhouse gases during product use and cut energy-related costs.

2 Installing and Setting up the Machine

This chapter provides information for the administrator of this machine, such as part names, cable connection, and software installation.

Part Names	2-2	Embedded Web Server RX	2-38
Machine Exterior	2-2	Accessing Embedded Web	
Connectors/Interior	2-3	Server RX	2-39
With Optional Equipments Attached ...	2-5	Changing Security Settings	2-40
Connecting the Machine and Other		Changing Device Information	2-42
Devices	2-6	E-mail Settings	2-44
Connecting Cables	2-7	Creating a New Custom Box	2-48
Connecting LAN Cable	2-7	Printing a document stored in a Custom	
Connecting USB Cable	2-8	Box	2-49
Connecting the Power Cable	2-8		
Power On/Off	2-9		
Power On	2-9		
Power Off	2-9		
Using the Operation Panel	2-10		
Operation Panel Keys	2-10		
Operation Method	2-11		
Help Screen	2-12		
Login/Logout	2-13		
Login	2-13		
Logout	2-14		
Default Settings of the Machine	2-15		
Setting Date and Time	2-15		
Network Setup	2-16		
Configuring the Wired Network	2-16		
Configuring the Wireless Network	2-18		
Setting Wi-Fi Direct	2-22		
Energy Saver function	2-24		
Sleep and Auto Sleep	2-24		
Power Off Rule			
(models for Europe)	2-25		
Installing Software	2-26		
Software on DVD (Windows)	2-26		
Installing Software in Windows	2-27		
Uninstalling the Software	2-33		
Installing Software			
in Mac Computer	2-34		
Checking the Counter	2-36		
Additional Preparations for			
the Administrator	2-37		
Strengthening the Security	2-37		

Part Names

Machine Exterior

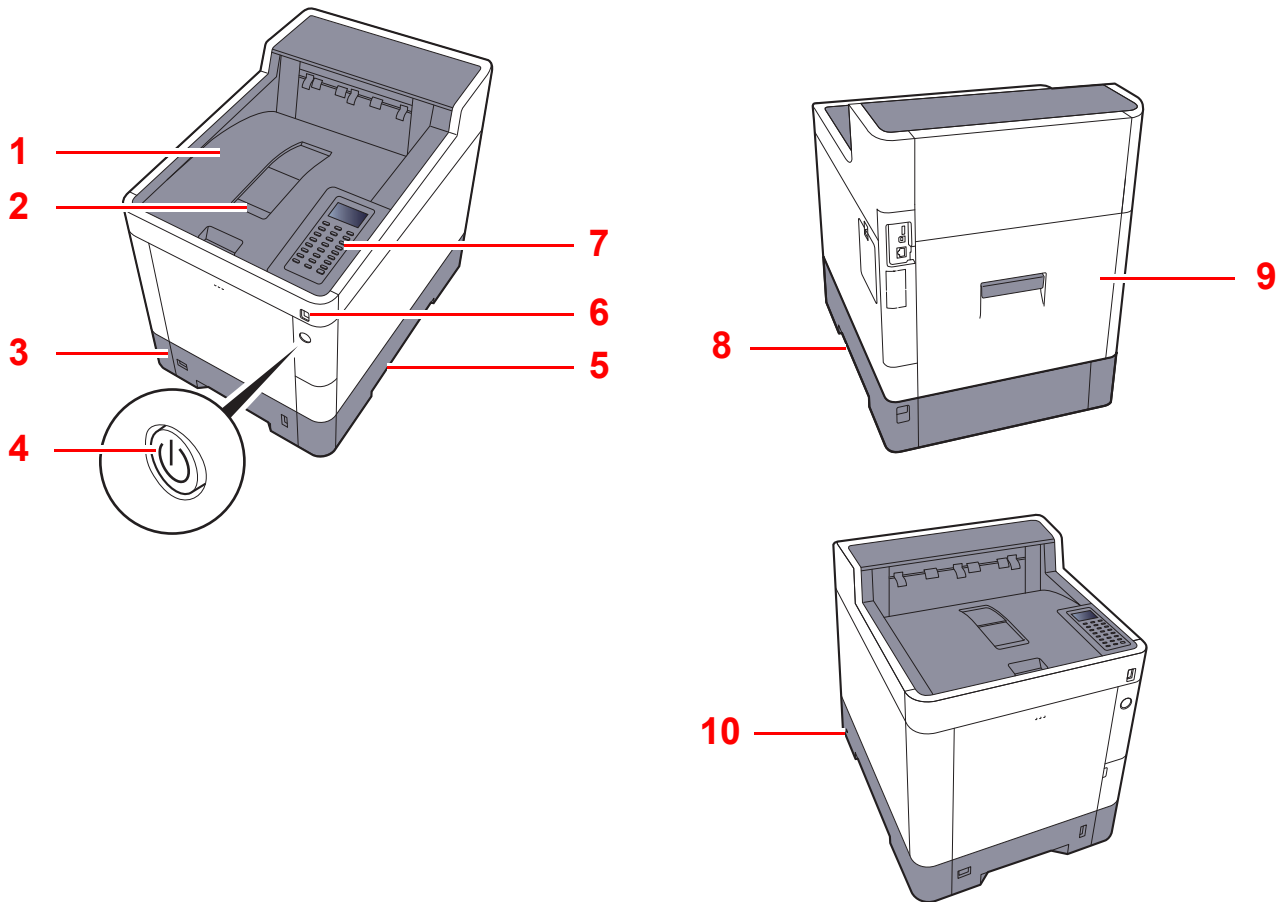

- 1 Top Tray
- 2 Paper Stopper
- 3 Cassette 1
- 4 Power Switch
- 5 Handles

- 6 USB Memory Slot
- 7 Operation Panel
- 8 Handles
- 9 Rear Cover 1
- 10 Anti-theft Lock Slot

Connectors/Interior

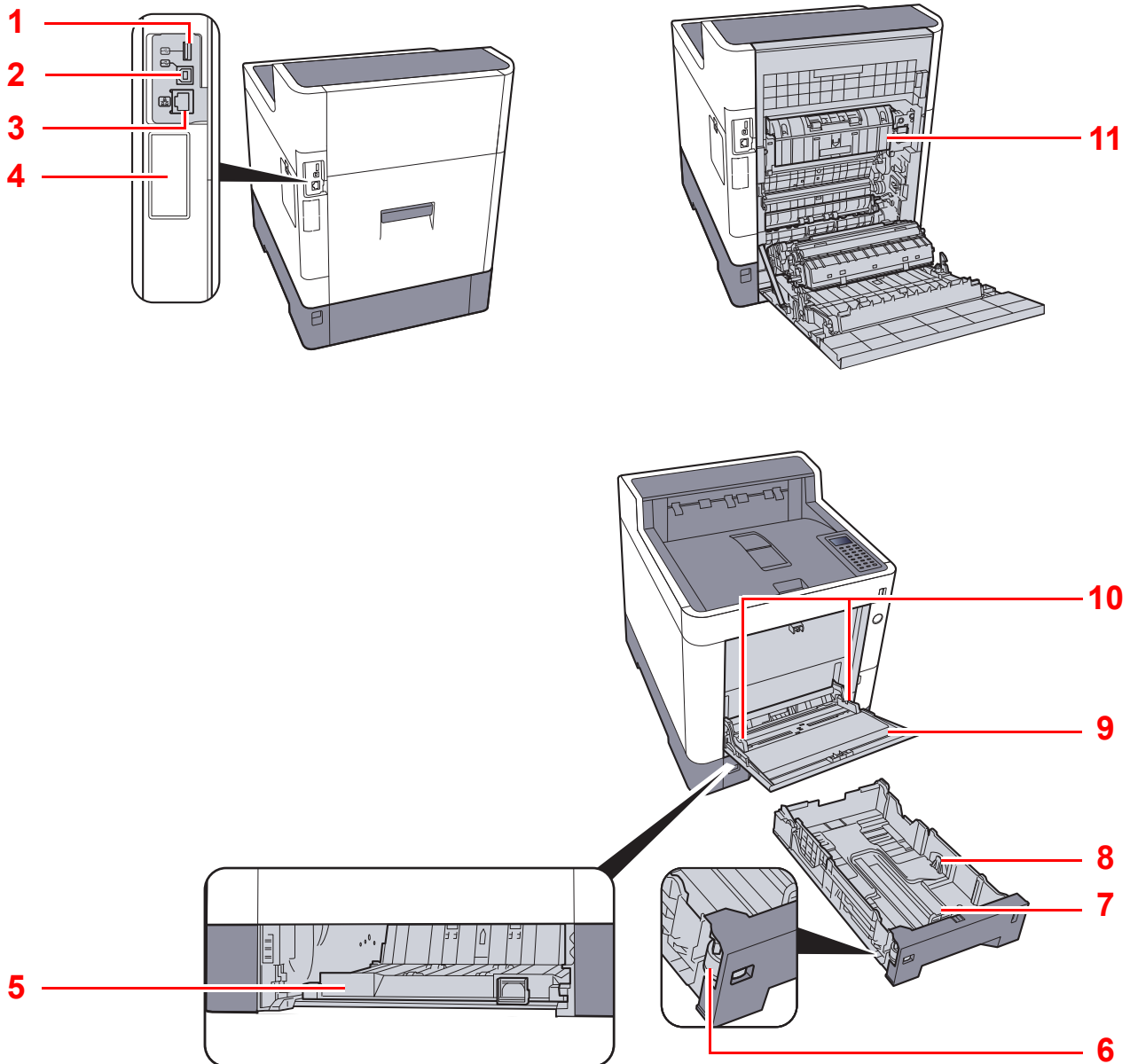

- 1 USB Port
- 2 USB Interface Connector
- 3 Network Interface Connector
- 4 Option Interface
- 5 Feed Cover
- 6 Size Dial

- 7 Paper Length Guide
- 8 Paper Width Guides
- 9 Multi Purpose Tray
- 10 Paper Width Guides
- 11 Fuser Cover

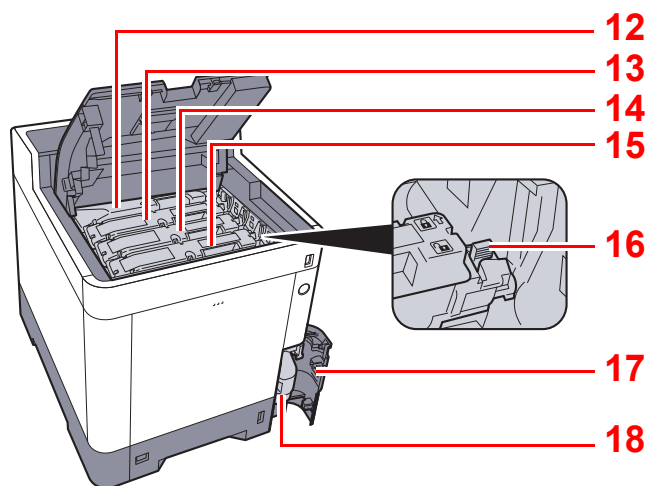

12 Toner Container (Black)

13 Toner Container (Magenta)

14 Toner Container (Cyan)

15 Toner Container (Yellow)

16 Toner Container Lock Lever

17 Waste Toner Cover

18 Waste Toner Box

With Optional Equipments Attached

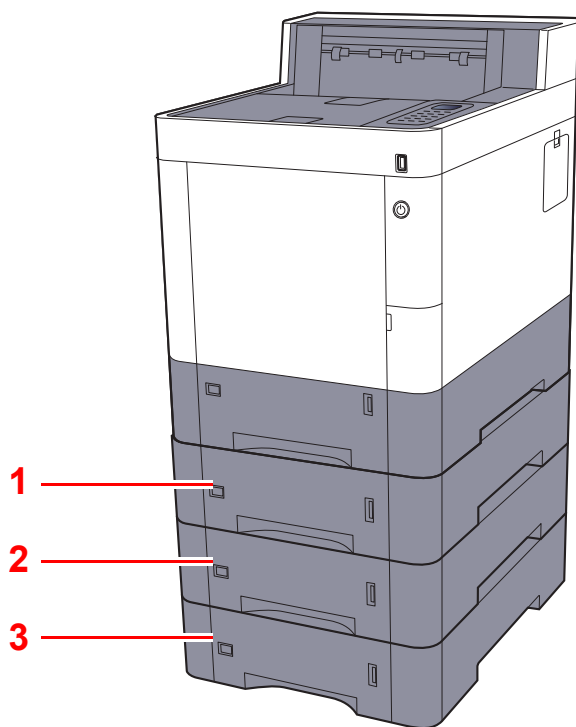

- 1 Cassette 2
- 2 Cassette 3
- 3 Cassette 4

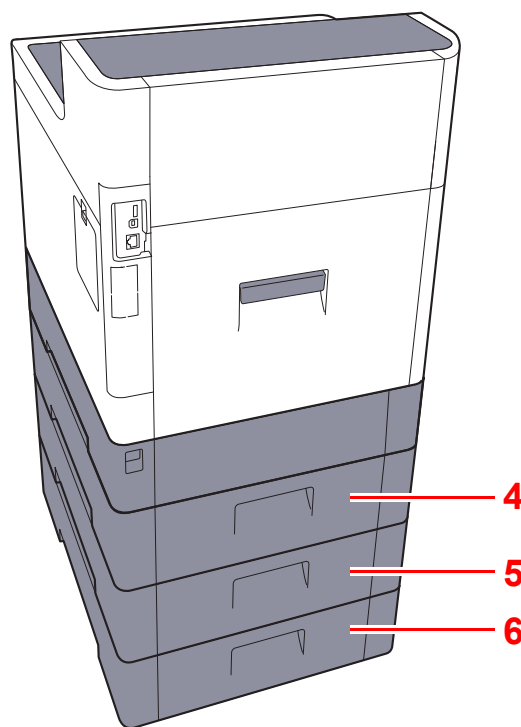

- 4 Rear Cover 2
- 5 Rear Cover 3
- 6 Rear Cover 4

➔ [Optional Equipment \(page 11-2\)](#)

Connecting the Machine and Other Devices

Prepare the cables necessary to suit the environment and purpose of the machine use.

When Connecting the Machine to the PC via USB

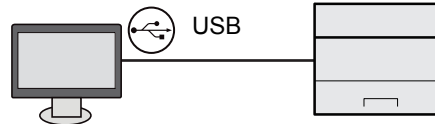

When Connecting the Machine to the PC or Tablet by network cable, Wi-Fi, or Wi-Fi direct

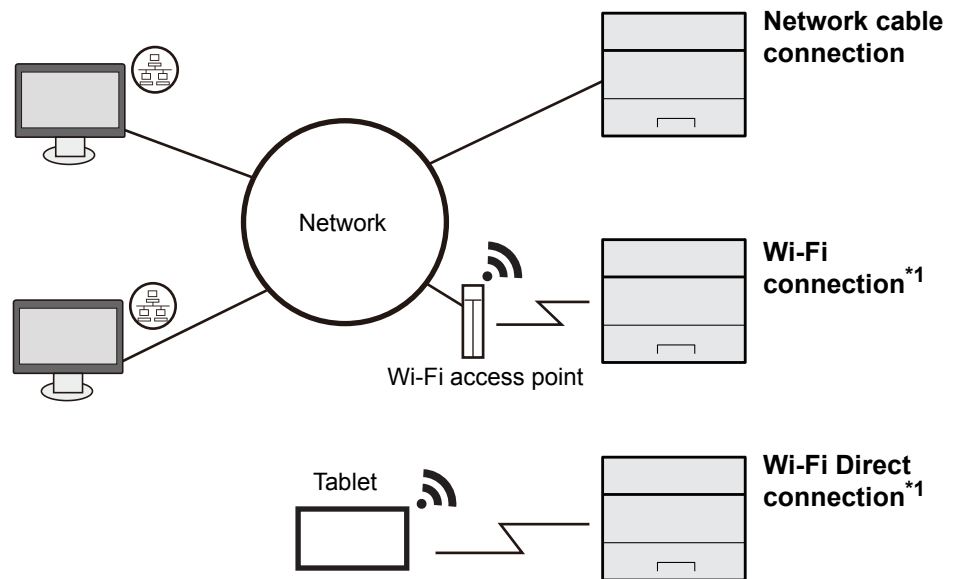

*1 Only for models with Wi-Fi.

NOTE

If you are using wireless LAN, refer to the following.

➔ [Configuring the Wireless Network \(page 2-18\)](#)

Cables that Can Be Used

Connection Environment	Function	Necessary Cable
Connect a LAN cable to the machine.	Printer	LAN cable (10BASE-T, 100BASE-TX, 1000BASE-T)
Connect a USB cable to the machine.	Printer	USB 2.0 compatible cable (Hi-Speed USB compliant, max. 5.0 m, shielded)

IMPORTANT

Using a cable other than a USB 2.0 compatible cable may cause failure.

Connecting Cables

Connecting LAN Cable

✔ **IMPORTANT**

If the power is on, turn the power switch off.

➔ [Power Off \(page 2-9\)](#)

1 Connect the cable to the machine.

- 1 Connect the LAN cable to the network interface connector.

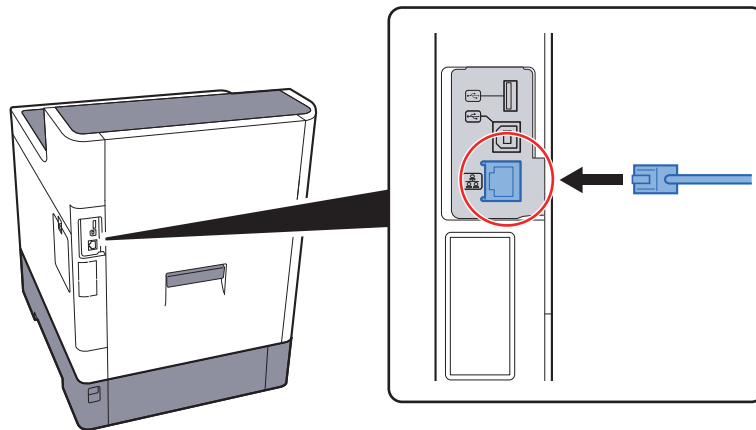

- 2 Connect the other end of the cable to the hub.

2 Power on the machine and configure the network.

➔ [Network Setup \(page 2-16\)](#)

Connecting USB Cable

✔ **IMPORTANT**

If the power is on, turn the power switch off.

➔ [Power Off \(page 2-9\)](#)

1 Connect the cable to the machine.

- 1 Connect the USB cable to the USB interface connector located on the left side of the body.

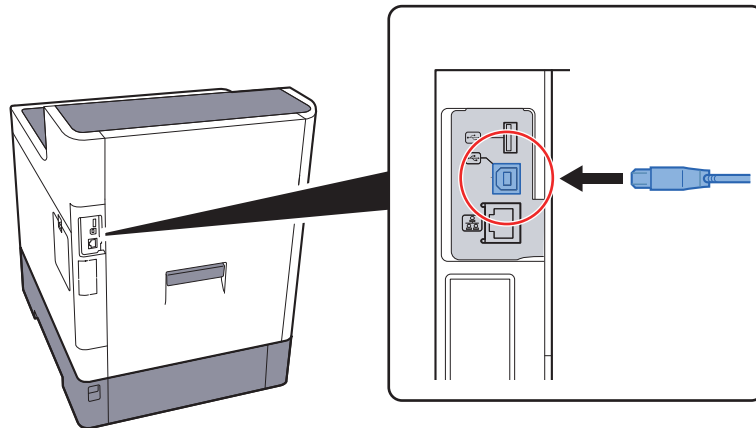

- 2 Connect the other end of the cable to the PC.

2 Power on the machine.

Connecting the Power Cable

1 Connect the cable to the machine.

Connect one end of the supplied power cable to the machine and the other end to a power outlet.

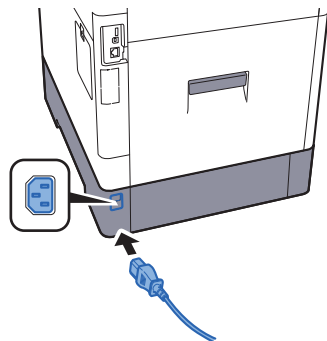

✔ **IMPORTANT**

Only use the power cable that comes with the machine.

Power On/Off

Power On

- 1 Turn the power switch on.

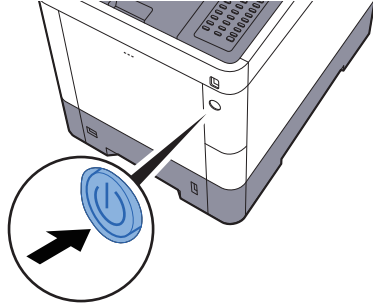

Power Off

- 1 Turn the power switch off.

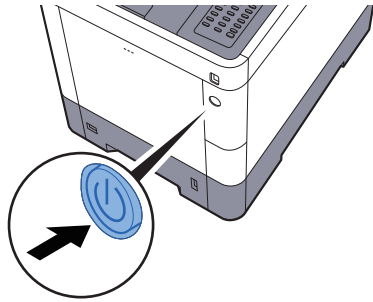

It takes about 3 minutes for power off.



CAUTION

If this machine will be left unused for an extended period (e.g. overnight), turn it off at the main power switch. If the machine will not be used for an even longer period of time (e.g. vacation), remove the power plug from the outlet as a safety precaution.







IMPORTANT

Remove paper from the cassettes and seal it in the paper storage bag to protect it from humidity.

Using the Operation Panel

Operation Panel Keys

	Displays the Menu screen.
	Increments or decrements numbers, or selects menu in the message display. In addition, moves the cursor when entering the characters.
	Finalizes a function or menu, and numbers that have been entered.
	Returns to the previous display.

Select Key:

Selects the menu displayed at the bottom of the message display.

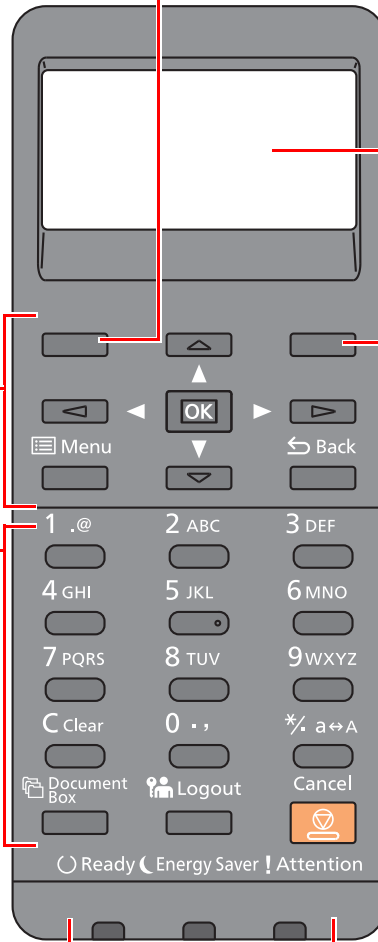







Message display:

Displays the setting menu and error messages.

Select Key:

Selects the menu displayed at the bottom of the message display.

	Numeric keys. Enter numbers and symbols.
	Displays the Document Box screen.
	Exits the operation for the current user (i.e. log out).
	Cancels or pauses the job in progress.

	Lights up in the print ready state. Blinks during print processing or when an error occurs.
	Lights up when the machine is in energy save mode.
	Lights or blinks when an error occurs and a job is stopped.

Operation Method

This section explains how to operate the setting menus on the message display.

Displaying the Menus and Configuring Settings

Select the **[Menu]** key to display the setting menus. Select the **[▲]** key, **[▼]** key, **[◀]** key, **[▶]** key, **[OK]** key, or **[Back]** key to select a menu, and perform settings.

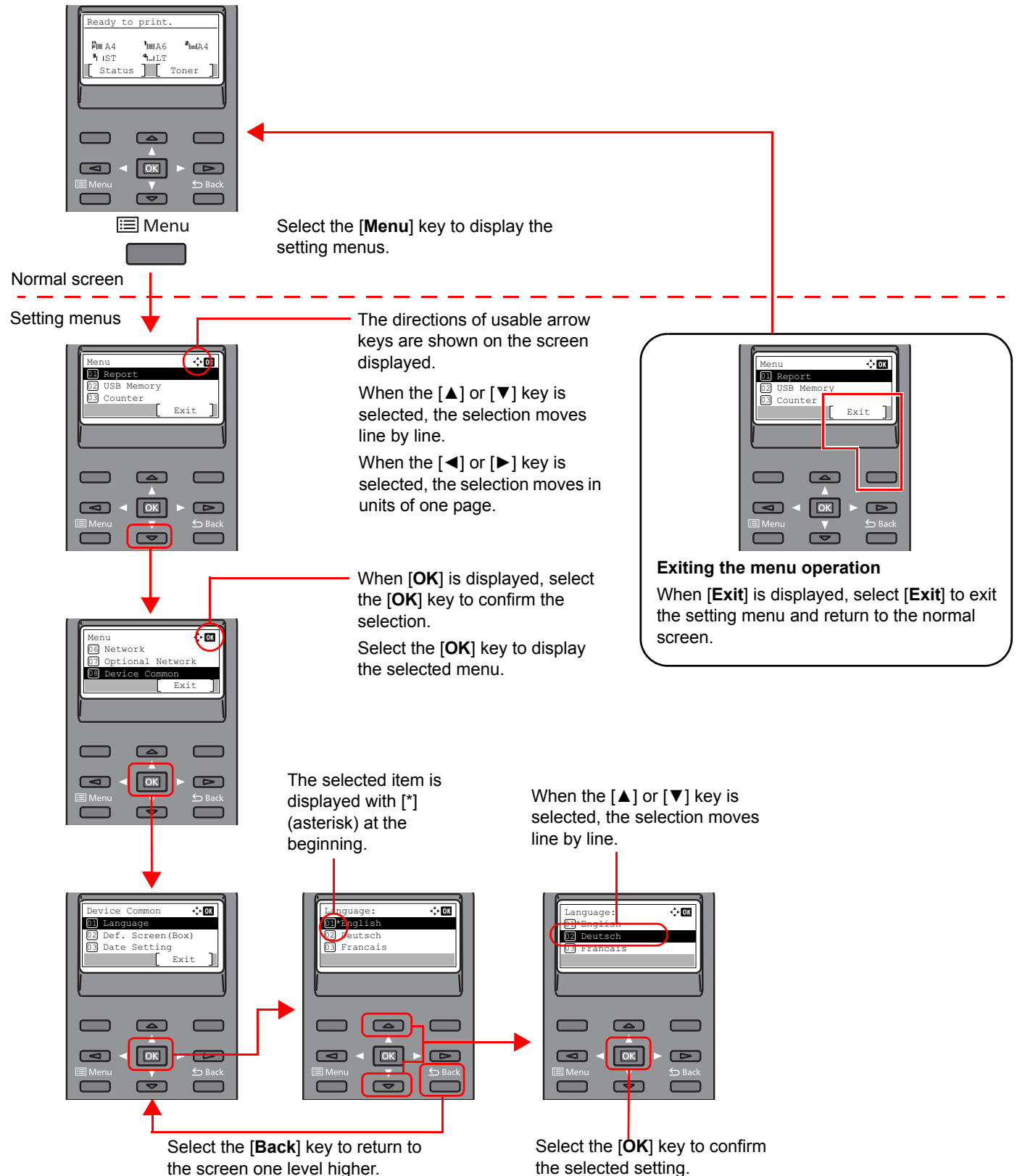

Help Screen

If you have difficulty operating the machine, you can check how to operate it using the operation panel.

When **[Help]** is displayed on the message display, select **[Help]** to display the Help screen. The Help screen shows machine operation.



Select the **[▼]** key to display the next step or select the **[▲]** key to display the previous step.

Select the **[OK]** key to exit the Help screen.

Login/Logout

If you are setting a function that requires administrator rights, or if user login administration is enabled, you must enter your login user name and login password.



NOTE

The factory default login user name and login password are set as shown below.

	P-C3562DN	P-C4072DN
Login User Name:	3500	4000
Login Password:	3500	4000

You will be unable to login if you forget your login user name or login password. In this event, login with administrator privileges and change your login user name or login password.

Login

1 Enter the login user name.

- 1 If the login screen is displayed during operations, select "Login User Name" and select the [OK] key.



NOTE

- If [Netwk Authentic.] is selected as the user authentication method, [Menu] is displayed. Select [Menu] and select [Login Type] and then it is possible to select the authentication destination as [Local Authentic.] or [Netwk Authentic.].
- Select [Menu] and select [Domain] and then it is possible to select from the domains registered.

- 2 Enter the login user name using the numeric keys and select the [OK] key.

➔ [Character Entry Method \(page 11-10\)](#)

2 Enter the login password.

- 1 Select "Login Password" and select the [OK] key.
- 2 Enter the login password and select the [OK] key.

➔ [Character Entry Method \(page 11-10\)](#)

3 Select [Login].

Logout

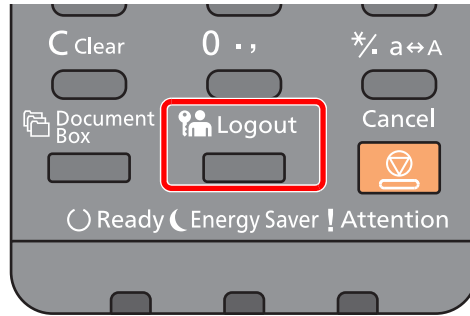

To logout from the machine, select the [**Logout**] key to return to the login user name/login password entry screen.

Users are automatically logged out in the following circumstances:

- When the machine enters the sleep state.
- When the auto panel reset function is activated.

Default Settings of the Machine

Before using this machine, configure such settings as date and time, network configuration, and energy saving functions as needed.

NOTE

The default settings of the machine can be changed in System Menu.
For settings that are configurable from System Menu, refer to the following:

➔ [Setup and Registration \(System Menu\) \(page 8-1\)](#)

Setting Date and Time

Follow the steps below to set the local date and time at the place of installation.

When you send an E-mail using the transmission function, the date and time as set here will be printed in the header of the E-mail message. Set the date, time and time difference from GMT of the region where the machine is used.

NOTE

- If user login administration is enabled, you can only change the settings by logging in with administrator privileges. If user login administration is disabled, the user authentication screen appears. Enter a login user name and password, and select [Login].
- The factory default login user name and login password are set as shown below.

	P-C3562DN	P-C4072DN
Login User Name:	3500	4000
Login Password:	3500	4000

- Be sure to set the time difference before setting the date and time.
- The correct time can be periodically set by obtaining the time from the network time server.

➔ [Embedded Web Server RX User Guide](#)

1 Display the screen.

[Menu] key > [▲] [▼] key > [Device Common] > [OK] key > [▲] [▼] key > [Date Setting] > [OK] key

2 Configure the settings.

[▲] [▼] key > [Time Zone] > [OK] key > Select the time zone > [OK] key > [▲] [▼] key > [Date] > [OK] key > Set the date > [OK] key > [▲] [▼] key > [Time] > [OK] key > Set the time > [OK] key > [▲] [▼] key > [Date Format] > [OK] key > Select the Date Format > [OK] key

Item	Description
Time Zone	Set the time difference from GMT. Choose the nearest listed location from the list. If you select a region that utilizes summer time, configure settings for summer time.
Date	Set the date for the location where you use the machine. Value: Year (2000 to 2037), Month (1 to 12), Day (1 to 31)
Time	Set the time for the location where you use the machine. Value: Hour (00 to 23), Minute (00 to 59), Second (00 to 59)
Date Format	Select the display format of year, month, and date. The year is displayed in Western notation. Value: Month/Day/Year, Day/Month/Year, Year/Month/Day

NOTE

Select the [▲] or [▼] key to enter a number.
Select the [◀] or [▶] key to move the position being entered, which is shown highlighted.

Network Setup

Configuring the Wired Network

The machine is equipped with network interface, which is compatible with network protocols such as TCP/IP (IPv4), TCP/IP (IPv6), NetBEUI, and IPSec. It enables network printing on the Windows, Macintosh, UNIX and other platforms.

Set up TCP/IP (IPv4) to connect to the Windows network.

Be sure to connect the network cable before configuring the settings.

➔ [Connecting LAN Cable \(page 2-7\)](#)

For other network settings, refer to the following:

➔ [Network \(page 8-12\)](#)



NOTE

If user login administration is enabled, you can only change the settings by logging in with administrator privileges. If user login administration is disabled, the user authentication screen appears. Enter a login user name and password, and select **[Login]**.

The factory default login user name and login password are set as shown below.

	P-C3562DN	P-C4072DN
Login User Name:	3500	4000
Login Password:	3500	4000

IPv4 setting

1 Display the screen.

[Menu] key > [▲] [▼] key > [Network] > [OK] key > [▲] [▼] key > [Wired Netwk. Set] > [OK] key > [▲] [▼] key > [TCP/IP Settings] > [OK] key > [▲] [▼] key > [IPv4 Setting] > [OK] key

2 Configure the settings.

When setting the static IP address

1 [▲] [▼] key > [DHCP] > [OK] key > [▲] [▼] key > [Off] > [OK] key

2 [▲] [▼] key > [IP Address] > [OK] key

3 Set the IP address.



NOTE

You can set any value between 000 and 255.

Use the numeric keys or select the [▲] or [▼] key to enter a number.

Select the [◀] or [▶] key to move the position being entered, which is shown highlighted.

4 Select the [OK] key.

5 [▲] [▼] key > [Subnet Mask] > [OK] key

- 6 Set the subnet mask.



NOTE

You can set any value between 000 and 255.
Use the numeric keys or select the [▲] or [▼] key to enter a number.
Select the [◀] or [▶] key to move the position being entered, which is shown highlighted.

- 7 Select the [OK] key.
- 8 [▲] [▼] key > [Default Gateway] > [OK] key
- 9 Set the default gateway.



NOTE

You can set any value between 000 and 255.
Use the numeric keys or select the [▲] or [▼] key to enter a number.
Select the [◀] or [▶] key to move the position being entered, which is shown highlighted.

- 10 Select the [OK] key.
- 11 [▲] [▼] key > [Auto-IP] > [OK] key
- 12 [Off] > [OK] key



IMPORTANT

After changing the setting, restart the network from System Menu, or turn the machine OFF and then ON.

➔ [Restart Network \(page 8-22\)](#)



NOTE

Ask your network administrator for the IP address in advance, and have it ready when you configure this setting.

In the following cases, set the IP address of DNS server on the Embedded Web Server RX.

- When using the host name with "DHCP" setting set to "Off"
- When using the DNS server with IP address that is not assigned by DHCP automatically.

Setting the IP Address of the DNS Server, refer to the following:

➔ **Embedded Web Server RX User Guide**

Configuring the Wireless Network

When the Wireless Network Interface Kit (IB-36 and IB-51) is installed on the machine and the connection settings are configured, it is possible to print or send in a wireless network (wireless LAN) environment.

➔ [Wireless Network Interface Kit \(IB-36\) \(page 11-7\)](#)

➔ [IB-51 "Wireless Network Interface Kit" \(page 11-5\)](#)

The configuration methods are as follows:

Configuration Method	Description	Reference Page
Configuring the Connection from the Operation Panel on This Machine	Use Wi-Fi Settings or Wireless Network to configure the network in details from System menu.	Wi-Fi Settings (page 8-13)
Setting the Connection by Using the Wi-Fi Setup Tool	This is the tool included in the Product Library. You can configure the connection according to the instructions provided by the wizard.	Setting the Connection by Using the Wi-Fi Setup Tool (page 2-18)
Configuring Connections on the Web Page	For the IB-36, the connection can be set from the Embedded Web Server RX.	Embedded Web Server RX User Guide
	For the IB-51, the connection can be set on the dedicated Web page.	IB-51 Operation Guide
Setting the Connection by Using the Setup Utility of IB-51	This is the setup tool included in the CD of IB-51. You can use it on both Windows and Mac OS.	IB-51 Operation Guide



NOTE

When you want to switch to the network interface other than Wired (default) after installing an optional Network Interface Kit (IB-50) and a Wireless Network Interface Kit (IB-36 or IB-51), select the desired setting on "Primary Network (Client)".

➔ [Primary Network \(page 8-21\)](#)

Setting the Connection by Using the Wi-Fi Setup Tool

To send the Wi-Fi settings configured in the Wi-Fi Setup Tool to the machine, connect the computer or handheld device with the machine locally. The connection methods are wired connection via LAN cable and wireless LAN connection (Wi-Fi Direct).



NOTE

- Before using the Wi-Fi Setup Tool, connect your computer to this machine locally with wired LAN cable or Wi-Fi Direct.
- To use Wi-Fi Direct, confirm that the Wi-Fi Direct is enabled (Wi-Fi Direct is set to [On]) and Restart Network from the operation panel, before your computer will be connected to this machine with Wi-Fi Direct.
- To use a wired LAN cable directly connected to the machine, the Auto-IP (Link-local) address will be assigned to the machine and the computer. This machine applies Auto-IP as the default settings.
- Configure the settings on the operation panel if your computer supports WPS.

➔ [Wi-Fi Settings \(page 8-13\)](#)

Wired Connection by Using LAN Cable

1 Connect the machine with a computer

- 1 Connect the machine with a computer via LAN cable when the machine is powered on.
- 2 Turn on the computer.
IP address (link local address) of the machine and computer is generated automatically.

2 Insert the DVD.

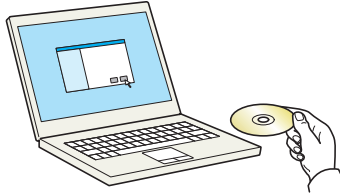

NOTE

- Installation on Windows must be done by a user logged on with administrator privileges.
- If the "Welcome to the Found New Hardware Wizard" dialog box displays, select **[Cancel]**.
- If the autorun screen is displayed, click **[Run setup.exe]**.
- If the user account management window appears, click **[Yes]** (**[Allow]**).

3 Display the screen.

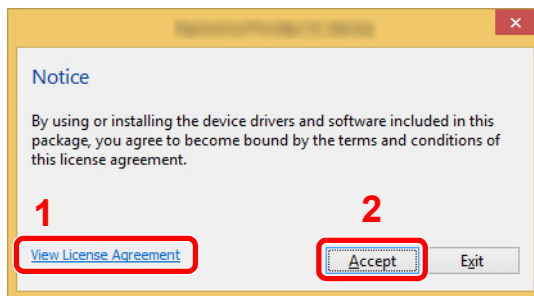

- 1 Click **[View License Agreement]** and read the License Agreement.
- 2 Click **[Accept]**.

4 Select **[Maintenance]**.

5 **[Wi-Fi Setup Tool]** > **[OK]**

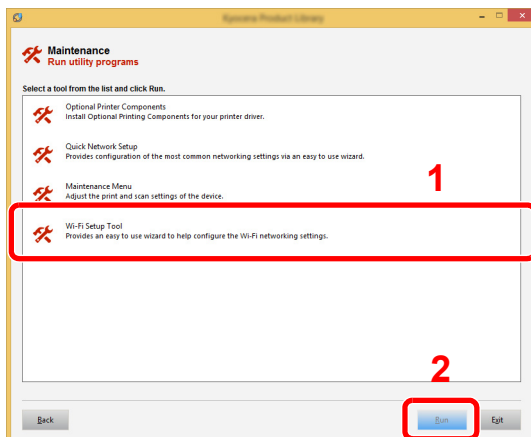

6 Configure the settings.

1 [Do not use automatic configuration] > [Next] > [Next]

2 [Use LAN cable] > [Next] > [Next]

3 [Easy setup] > [Next]

The machine is detected.

NOTE

- Only one machine can be searched using Wi-Fi Setup Tool. It may take times to search the machine.
- If the machine is not detected, select [Advanced setup] > [Next]. Select [Express] or [Custom] as device discovery method and specify the IP address or host name to search the machine.

4 Select the machine > [Next]

5 Select [Use the device settings.] on [Authentication mode], and enter the login user name and password. Login user name and Password are both Admin.

6 Configure the communication settings > [Next]

7 Change the settings of access point as necessary > [Next]

The network is configured.

Wireless LAN Connection by Using Wi-Fi Direct

1 Display the screen.

[Menu] key > [▲] [▼] key > [Network] > [OK] key > [▲] [▼] key > [Wi-Fi Direct Set] > [OK] key > [▲] [▼] key > [Wi-Fi Direct] > [OK] key

2 Configure the settings.

[▲] [▼] key > [On] > [OK] key

3 Restart the network.

[Menu] key > [▲] [▼] key > [Network] > [OK] key > [▲] [▼] key > [Restart Network] > [OK] key > [Yes]

4 Connect a computer or a handheld device with the machine.

➔ [Setting Wi-Fi Direct \(page 2-22\)](#)

5 Insert the DVD.

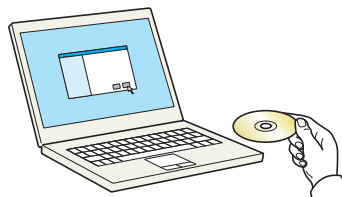



NOTE

- Installation on Windows must be done by a user logged on with administrator privileges.
- If the "Welcome to the Found New Hardware Wizard" dialog box displays, select [Cancel].
- If the autorun screen is displayed, click [Run setup.exe].
- If the user account management window appears, click [Yes] ([Allow]).

6 Display the screen.

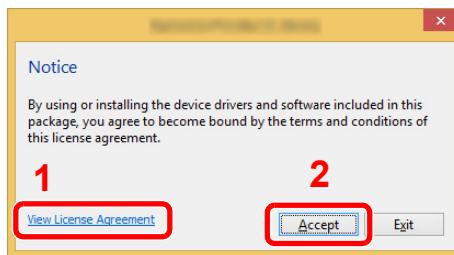

- 1 Click [View License Agreement] and read the License Agreement.
- 2 Click [Accept].

7 Select [Maintenance].

8 [Wi-Fi Setup Tool] > [OK]

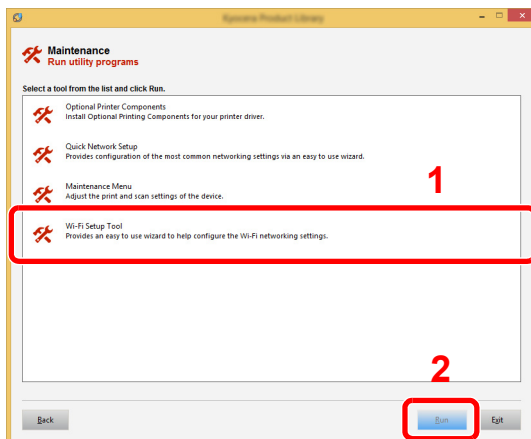

9 Configure the settings.

- 1 [Do not use automatic configuration] > [Next] > [Next]
- 2 [Wi-Fi Direct] > [Next] > [Next]
- 3 [Advanced setup] > [Next]
Select [Express] or [Custom] as device discovery method and specify the IP address or host name to search the machine.
- 4 Select the machine > [Next]
- 5 Select [Use the device settings.] on [Authentication mode], and enter the login user name and password. Login user name and Password are both Admin.
- 6 Configure the communication settings > [Next]
- 7 Change the settings of access point as necessary > [Next]
The network is configured.

Setting Wi-Fi Direct

You can install the optional Wireless Network Interface Kit (IB-36) on the machine and configure the connection settings to print in a Wi-Fi Direct environment. The configuration methods are as follows:

Configuring the Connection from the Operation Panel on This Machine

Connecting to Computers or Handheld Devices that Support Wi-Fi Direct

1 Display the screen.

[Menu] key > [▲] [▼] key > [Network] > [OK] key > [▲] [▼] key > [Wi-Fi Direct Set] > [OK] key > [▲] [▼] key > [Wi-Fi Direct] > [OK] key

2 Configure the settings.

[▲] [▼] key > [On] > [OK] key

3 Restart the network.

[Menu] key > [▲] [▼] key > [Network] > [OK] key > [▲] [▼] key > [Restart Network] > [OK] key > [Yes]

4 Specify the machine name from the computer or handheld device.

If a confirmation message appears on the operation panel of the machine, select [Yes].

The network between this machine and the handheld device is configured.

Connecting to Computers or Handheld Devices Unsupported Wi-Fi Direct

Here, we'll explain the procedures for connecting to iOS handheld devices.

1 Display the screen.

[Menu] key > [▲] [▼] key > [Network] > [OK] key > [▲] [▼] key > [Wi-Fi Direct Set] > [OK] key > [▲] [▼] key > [Wi-Fi Direct] > [OK] key

2 Configure the settings.

[▲] [▼] key > [On] > [OK] key

3 Restart the network.

[Menu] key > [▲] [▼] key > [Network] > [OK] key > [▲] [▼] key > [Restart Network] > [OK] key > [Yes]

4 [Status] key > [▲] [▼] key > [Wi-Fi Direct] > [OK] key

5 [▲] [▼] key > [Detail Info] > [OK] key

6 Check the network name (SSID), password, and IP address with the [◀] [▶] keys, and make a note this information.

7 Configure the handheld device.

1 [Settings] > [Wi-Fi]

2 Select the network name (SSID) appeared in step 6 from the list.

3 Enter the password that was provided in step 6 > [Connect]

The network between this machine and the handheld device is configured.

Configuring the Connection by Using Push Button

When your computer or handheld device does not support Wi-Fi Direct but supports WPS, you can configure the network using push button.

1 Display the screen.

[Menu] key > [▲] [▼] key > [Network] > [OK] key > [▲] [▼] key > [Wi-Fi Direct Set] > [OK] key > [▲] [▼] key > [Wi-Fi Direct] > [OK] key

2 Configure the settings.

[▲] [▼] key > [On] > [OK] key

3 Restart the network.

[Menu] key > [▲] [▼] key > [Network] > [OK] key > [▲] [▼] key > [Restart Network] > [OK] key > [Yes]

4 [Status] key > [▲] [▼] key > [Wi-Fi Direct] > [OK] key > [PushButton Setup] > [OK] key

5 Press the push button on the computer or handheld device and select [Push Button] on the screen of operation panel simultaneously > [Next].

The network between this machine and the computer or handheld device is configured.

IMPORTANT

You can connect up to three handheld devices at the same time using Wi-Fi Direct setting. When the devices that support Wi-Fi Direct are connected, if you want to connect other device, disconnect the already-connected devices from the network. The disconnection methods are as follows:

- Disconnect the network from the computer or handheld computer
- Disconnecting all devices from the network on the operation panel
Select [Wi-Fi Direct] key > [▲] [▼] key > [ConnectionStatus] > [OK] key > [Menu] > [▲] [▼] key > [Disconnect All] > [OK] key
- Configuring auto disconnecting time from the System menu
➔ [Wi-Fi Settings \(page 8-13\)](#)
- Configuring auto disconnecting time from the Embedded Web Server RX
➔ [Embedded Web Server RX User Guide](#)

Energy Saver function

If a certain period of time elapses after the machine is last used, the machine automatically enters sleep mode, which minimizes power consumption.

Sleep and Auto Sleep

NOTE

If user login administration is enabled, you can only change the settings by logging in with administrator privileges. If user login administration is disabled, the user authentication screen appears. Enter a login user name and password, and select **[Login]**.

The factory default login user name and login password are set as shown below.

	P-C3562DN	P-C4072DN
Login User Name:	3500	4000
Login Password:	3500	4000

Auto Sleep

Auto Sleep automatically switches the machine into Sleep if left idle for a preset time.

The default preset time is 1 minute.

To resume, perform the following actions.

- Select the **[OK]** key.

The machine will be ready to operate within 19 seconds for P-C3562DN and 21 seconds for P-C4072DN.

Note that ambient environmental conditions, such as ventilation, may cause the machine to respond more slowly.

Follow the steps below to set the sleep timer for the machine to go into sleep mode when not in use.

1 Display the screen.

[Menu] key > **[▲]** **[▼]** key > **[Device Common]** > **[OK]** key > **[▲]** **[▼]** key > **[Timer Setting]** > **[OK]** key > **[▲]** **[▼]** key > **[Sleep Timer]** > **[OK]** key

2 Set the Sleep time.

- 1 Enter the Sleep time.

NOTE

Use the numeric keys or select the **[▲]** or **[▼]** key to enter a number.

- 2 Select the **[OK]** key.

Status (Sleep Level Set.)

You can set whether sleep mode operates for each function. When the machine enters sleep mode, the ID card cannot be recognized.

For more information on Status, refer to the following:

➔ [Status \(page 8-28\)](#)

Sleep Level (Energy Saver and Quick Recovery) (models except for Europe)

For sleep level, you can toggle between the following two modes: Energy Saver mode and Quick Recovery mode. The default setting is Energy Saver mode.

Energy Saver mode reduces power consumption even more than Quick Recovery mode, and allows Sleep Mode to be set separately for each function. The ID card cannot be recognized.



NOTE

If the optional Network Interface Kit is installed, this function will not be displayed.

Follow the steps below to select the sleep level and use Energy Saver mode for each function.

1 Display the screen.

[Menu] key > [▲] [▼] key > [Device Common] > [OK] key > [▲] [▼] key > [Timer Setting] > [OK] key > [▲] [▼] key > [Sleep Level Set.] > [OK] key > [▲] [▼] key > [Sleep Level] > [OK] key

2 Select the Sleep level.

[▲] [▼] key > [Quick Recovery] or [Energy Saver] > [OK] key

When [Energy Saver] is set, next go on to set whether or not to use Energy Saver mode for each function.

3 Set the Sleep rule.

1 [▲] [▼] key > [Status] > [OK] key

2 Select the function to be set, and select the [OK] key.

[Card Reader] is displayed when the optional Card Authentication Kit is activated.

3 [▲] [▼] key > [Off] or [On] > [OK] key

Repeat steps 3-2 to 3-3 to set for a different function.

Power Off Rule (models for Europe)

The Power Off Rule is used to stop the power from automatically turning off.

The default preset time is 3 days.

For more information on Power Off Rule settings, refer to the following:

➔ [Power Off Rule \(models for Europe\) \(page 8-29\)](#)

Installing Software

Install appropriate software on your PC from the included DVD (Product Library) if you want to use the printer function of this machine.

Software on DVD (Windows)

You can use either [**Express Install**] or [**Custom Install**] can be selected for the installation method. [**Express Install**] is the standard installation method. To install components that cannot be installed by [**Express Install**], use [**Custom Install**].

For details on Custom Installation, refer to the following:

➔ [Custom Install \(page 2-29\)](#)

Software	Description	Express Install
Printing System Driver	This driver enables files on a computer to be printed by the machine. Multiple page description languages (PCL XL, KPD, etc.) are supported by a single driver. This printer driver allows you to take full advantage of the features of the machine. Use this driver to create PDF files.	<input type="radio"/>
Printing System (XPS) Driver	This printer driver supports the XPS (XML Paper Specification) format developed by Microsoft Corporation.	-
KPDL mini-driver/PCL mini-driver	This is a Microsoft MiniDriver that supports PCL and KPDL. There are some restrictions on the machine features and option features that can be used with this driver.	-
NETWORK PRINT MONITOR	This is a utility that enables monitoring of the machine on the network.	-
Status Monitor	This is a utility that monitors the printer status and provides an ongoing reporting function.	<input type="radio"/>
Network Tool for Direct Printing	This makes it possible to print a PDF file without starting Adobe Acrobat/Reader.	-
FONTS	These are display fonts that enable the machine's built-in fonts to be used in a software application.	<input type="radio"/>



NOTE

Installation on Windows must be done by a user logged on with administrator privileges.

Installing Software in Windows

Express Install

The following procedure is an example for installing the software in Windows 8.1 using **[Express Install]**.

For details on Custom Installation, refer to the following:

➔ [Custom Install \(page 2-29\)](#)

1 Insert the DVD.

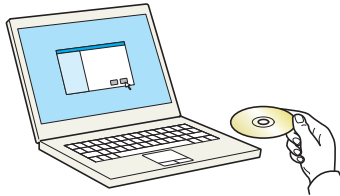

NOTE

- Installation on Windows must be done by a user logged on with administrator privileges.
- If the "Welcome to the Found New Hardware Wizard" dialog box displays, select **[Cancel]**.
- If the autorun screen is displayed, click **[Run setup.exe]**.
- If the user account management window appears, click **[Yes]**.

2 Display the screen.

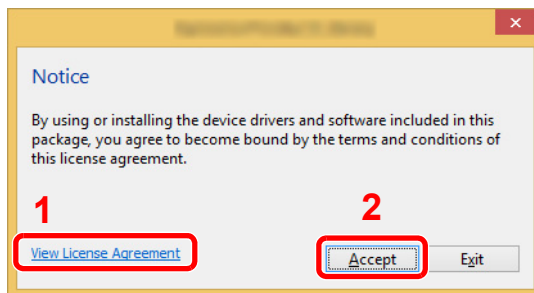

- 1 Click **[View License Agreement]** and read the License Agreement.
- 2 Click **[Accept]**.

3 Select **[Express Install]**.

4 Install the software.

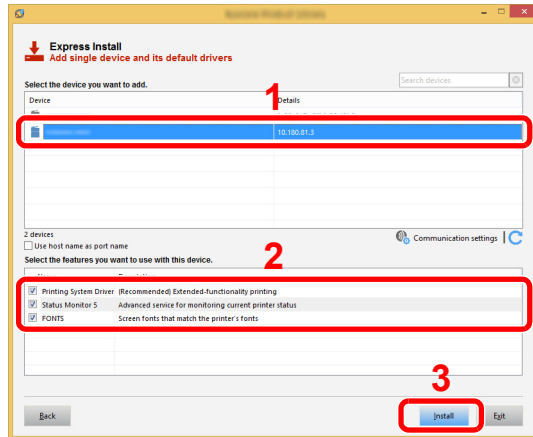

You can also select [**Use host name for port name**] and set to use the host name of the standard TCP/IP port. (A USB connection cannot be used.)

When you click [**Install**], a screen asking for your cooperation with data collection will be displayed. Select one of the answer choices and click [**OK**].

✓ IMPORTANT

If Wi-Fi or Wi-Fi Direct is enabled, be sure to specify the IP address for the port name. Installation may fail if the host name is specified.

💡 NOTE

- The machine cannot be detected unless it is on. If the computer fails to detect the machine, verify that it is connected to the computer via a network or USB cable and that it is turned on and click **C** (Reload).
- If the Windows security window appears, click [**Install this driver software anyway**].
- To install Status Monitor on Windows versions preceding Windows 8, it is necessary to install Microsoft .NET Framework 4.0 beforehand.

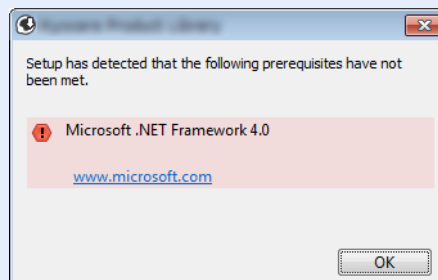

5 Finish the installation.

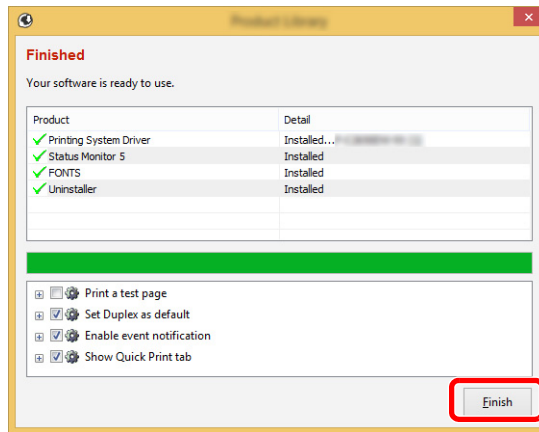

When "**Your software is ready to use**" appears, you can use the software. To print a test page, click the "**Print a test page**" checkbox and select the machine.

Click [**Finish**] to exit the wizard.

If a system restart message appears, restart the computer by following the screen prompts. This completes the printer driver installation procedure.

Custom Install

The following procedure is an example for installing the software in Windows 8.1 using [**Custom Install**].

1 Insert the DVD.

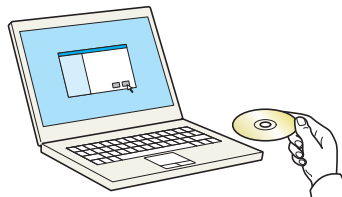

NOTE

- Installation on Windows must be done by a user logged on with administrator privileges.
- If the "**Welcome to the Found New Hardware Wizard**" dialog box displays, select [**Cancel**].
- If the autorun screen is displayed, click [**Run setup.exe**].
- If the user account management window appears, click [**Yes**].

2 Display the screen.

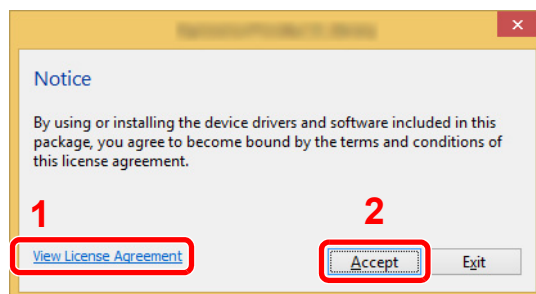

- 1 Click [**View License Agreement**] and read the License Agreement.
- 2 Click [**Accept**].

3 Select [**Custom Install**].

4 Install the software.

1 Select the device to be installed.

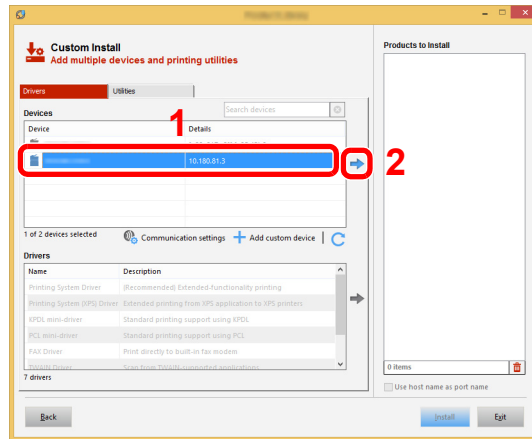

✓ IMPORTANT

If Wi-Fi or Wi-Fi Direct is enabled, be sure to specify the IP address for the port name. Installation may fail if the host name is specified.

🔧 NOTE

- The machine cannot be detected unless it is on. If the computer fails to detect the machine, verify that it is connected to the computer via a network or USB cable and that it is turned on and click  (Reload).
- If the desired device does not appear, select **[Add custom device]** to directly select the device.

2 Select the driver to be installed.

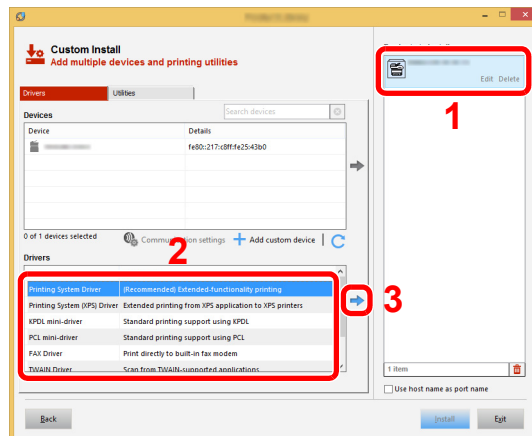

3 Click [**Utility**] tab and select the utility to be installed.

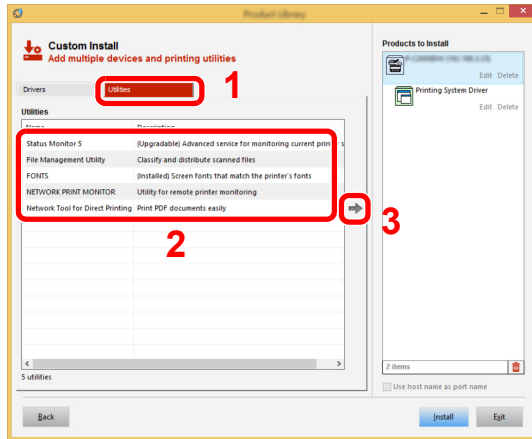

4 Click [**Install**].

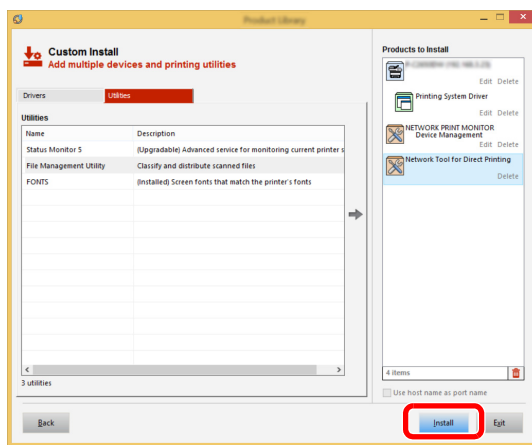

When you click [**Install**], a screen asking for your cooperation with data collection will be displayed. Select one of the answer choices and click [**OK**].

NOTE

To install Status Monitor on Windows versions preceding Windows 8, it is necessary to install Microsoft .NET Framework 4.0 beforehand.

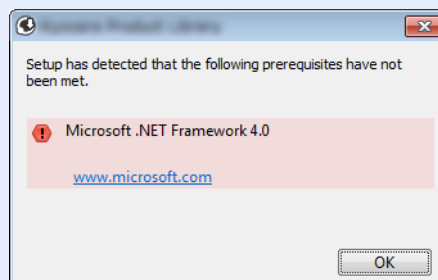

5 Finish the installation.

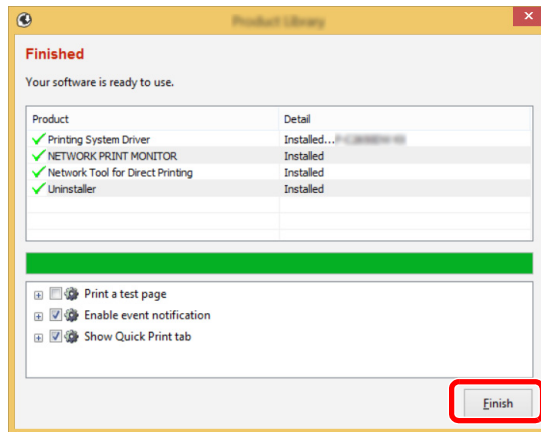

When "**Your software is ready to use**" appears, you can use the software. To print a test page, click the "**Print a test page**" checkbox and select the machine.

Click [**Finish**] to exit the wizard.

If a system restart message appears, restart the computer by following the screen prompts. This completes the printer driver installation procedure.

Uninstalling the Software

Perform the following procedure to delete the Software from your computer.

NOTE

Uninstallation on Windows must be done by a user logged on with administrator privileges.

1 Display the screen.

Click **[Search]** in charms, and enter "Uninstall Product Library" in the search box. Select **[Uninstall Product Library]** in the search list.

NOTE

In Windows 7, click **[Start]** button on the Windows and then select **[All Programs]**, **[(name of offer company)]**, and **[Uninstall Product Library]** to display the Uninstall Wizard.

2 Uninstall the software.

Place a check in the check box of the software to be deleted.

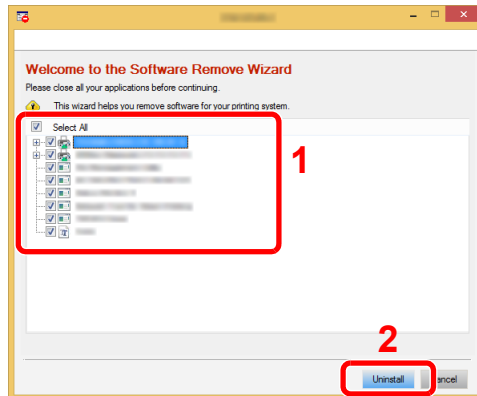

3 Finish uninstalling.

If a system restart message appears, restart the computer by following the screen prompts. This completes the software uninstallation procedure.

NOTE

- The software can also be uninstalled using the Product Library.
- In the Product Library screen, click **[Uninstall]**, and follow the on-screen instructions to uninstall the software.

Installing Software in Mac Computer

The machine's printer functionality can be used by a Mac computer.

NOTE

- Installation on MAC OS must be done by a user logged on with administrator privileges.
- When printing from a Macintosh computer, set the machine's emulation to **[KPDL]** or **[KPDL(Auto)]**.
- ➔ [Print Settings \(page 8-10\)](#)
- If connecting by Bonjour, enable Bonjour in the machine's network settings.
- ➔ [Bonjour \(page 8-16\)](#)
- In the Authenticate screen, enter the name and password used to log in to the operating system.
- When printing via AirPrint, you do not have to install the software.

1 Insert the DVD.

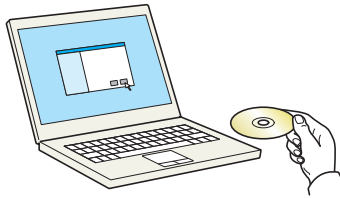

Double-click the **[GEN_LIB]** icon.

2 Display the screen.

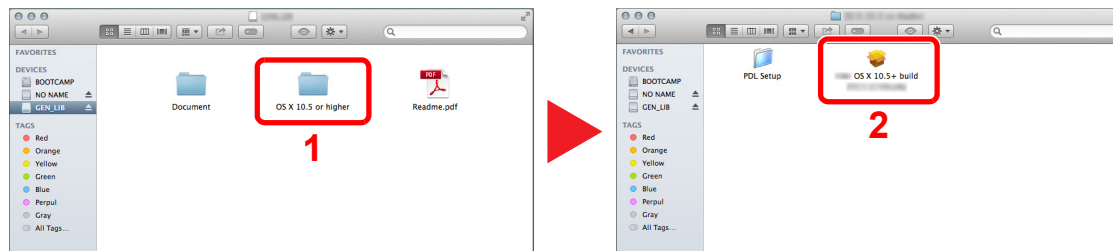

Double-click **[(Brand Name) OS X x.x]** depending on your Mac OS version.

3 Install the Printer Driver.

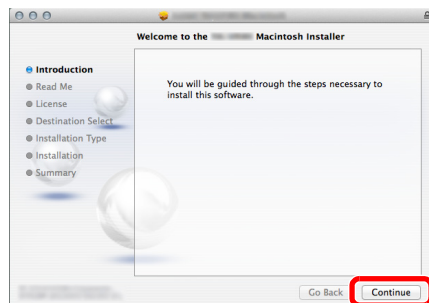

Install the printer driver as directed by the instructions in the installation software.

This completes the printer driver installation.

If a USB connection is used, the machine is automatically recognized and connected.
If an IP connection is used, the settings below are required.

4 Configure the printer.

- 1 Open System Preferences and add the printer.

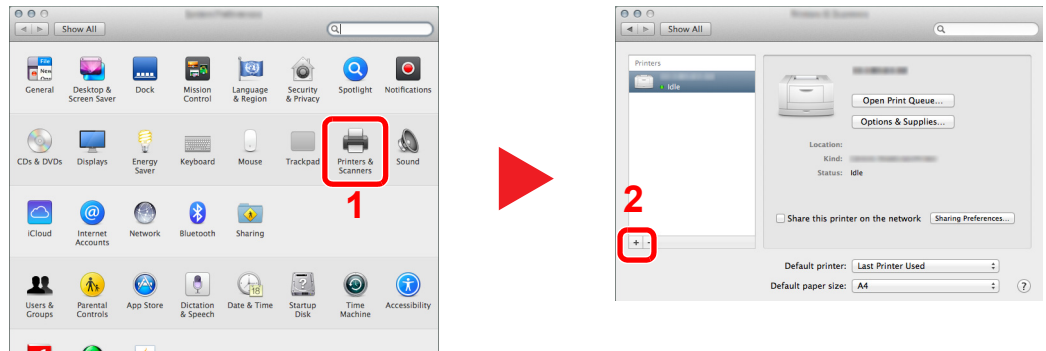

- 2 Select [Default] and click the item that appears in "Name" and then select the driver in "Use".

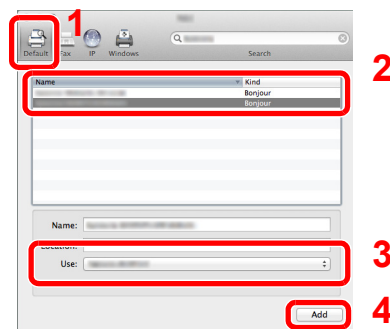

NOTE

When using an IP connection, click the IP icon for an IP connection and then enter the host name or IP address. The number entered in "Address" will automatically appear in "Name". Change if needed.

- 3 Select the options available for the machine.

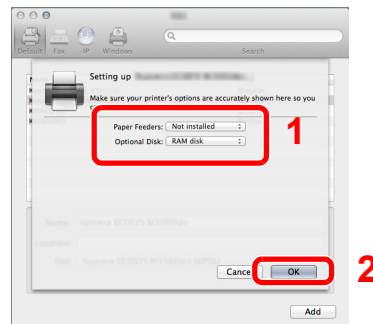

- 4 The selected machine is added.

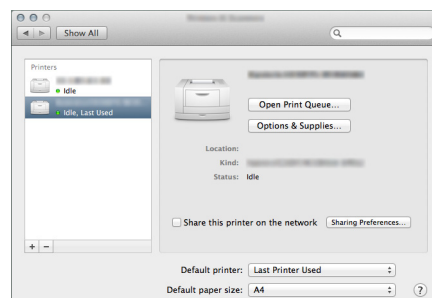

Checking the Counter

Check the number of sheets printed.

1 Display the screen.

[Menu] key > [▲] [▼] key > [Counter] > [OK] key

2 Check the counter.

Select the item you want to check, and select the [OK] key.

Additional Preparations for the Administrator

In addition to the information provided in this chapter, the administrator of this machine should check the following, and configure the settings as needed.

Strengthening the Security

This machine is shipped with two default users registered one with Machine Administrator rights, and another with Administrator rights. Logging in as this user will allow you to configure all settings; therefore, please change the login user name and password.

In addition, this machine is equipped with user authentication function, which can be configured to limit the access to this machine to only those who have a registered login name and password.

➔ [User Authentication and Accounting \(User Login, Job Accounting\) \(page 9-1\)](#)

I want to...	Function	Reference page
Restrict the users of the machine.	User Login	page 9-2
	Auto Panel Reset	page 8-28
	ID Card Settings ^{*1}	page 9-11
Prevent another user from handling the documents stored in the machine.	Custom Box ^{*2}	page 5-5
Prevent the data stored in the machine from being leaked.	Data Overwrite ^{*3}	Refer to the Data Security Kit (E) Operation Guide.
	Encryption ^{*3}	
Completely delete the data on the machine before disposing of the machine.	DataSanitization	page 8-33
Protect the transmission from interception and wiretapping.	IPP over SSL	page 8-18
	HTTPS	page 8-19
	SMTP Security	Embedded Web Server RX User Guide
	POP3 Security	Embedded Web Server RX User Guide
	IPSec	page 8-24
	SNMPv3	page 8-16

*1 The optional Card Authentication Kit is required.

*2 The optional SSD is required.

*3 The optional Data Security Kit is required.

Embedded Web Server RX

If the machine is connected to the network, you can configure various settings using Embedded Web Server RX.

This section explains how to access Embedded Web Server RX, and how to change security settings and the host name.

➔ Embedded Web Server RX User Guide

NOTE

To fully access the features of the Embedded Web Server RX pages, enter the User Name and Password and click [**Login**]. Entering the predefined administrator password allows the user to access all pages, including Document Box. The factory default setting for the default user with administrator privileges is shown below. (Upper case and lower case letters are distinguished (case sensitive).)

Login User Name: Admin

Login Password: Admin

Settings that the administrator and general users can configure in Embedded Web Server RX are as follows.

Setting	Description	Administ- rator	General User
Device Information	The machine's structure can be checked.	<input type="radio"/>	<input type="radio"/>
Job Status	Displays all device information, including print jobs, and job log history.	<input type="radio"/>	<input type="radio"/>
Document Box	Add or delete document boxes, or delete documents within a document box.	<input type="radio"/>	<input type="radio"/> *1
Device Settings	Configure the advanced settings of the machine.	<input type="radio"/>	-
Function Settings	Configure the advanced function settings.	<input type="radio"/>	-
Network Settings	Configure the network advanced settings.	<input type="radio"/>	-
Security Settings	Configure the security advanced settings.	<input type="radio"/>	-
Management Settings	Configure the advanced management settings.	<input type="radio"/>	-

*1 The logged in user may not be able to configure some settings, depending on the permissions of the user.

Accessing Embedded Web Server RX

1 Display the screen.

- 1 Launch your Web browser.
- 2 In the address or location bar, enter the machine's IP address or the host name.
Print the status page to check the machine's IP address and the host name.
[Menu] key > [▲][▼] key > [Report] > [OK] key > [▲][▼] key > [Report Print] > [OK] key > [▲][▼] key > [Status Page] > [OK] key > [Yes]

Examples: `https://10.180.81.2/` (for IP address)
`https://MFP001` (if the host name is "MFP001")

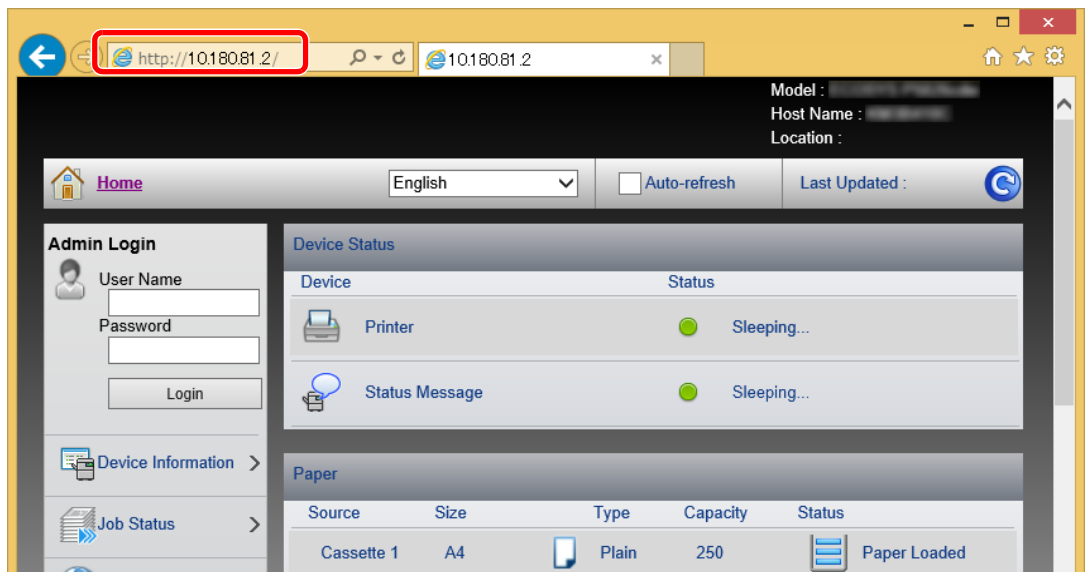

The web page displays basic information about the machine and Embedded Web Server RX as well as their current status.

NOTE

If the screen "There is a problem with this website's security certificate." is displayed, configure the certificate.

➔ [Embedded Web Server RX User Guide](#)

You can also continue the operation without configuring the certificate.

2 Configure the function.

Select a category from the navigation bar on the left of the screen.

NOTE

To fully access the features of the Embedded Web Server RX pages, enter the User Name and Password and click [Login]. Entering the predefined administrator password allows the user to access all pages, including Document Box. The factory default setting for the default user with administrator privileges is shown below. (Upper case and lower case letters are distinguished (case sensitive).)

Login User Name: Admin
Login Password: Admin

Changing Security Settings

1 Display the screen.

1 Launch your Web browser.

2 In the address or location bar, enter the machine's IP address or the host name.

Print the status page to check the machine's IP address and the host name.

[Menu] key > [▲] [▼] key > [Report] > [OK] key > [▲] [▼] key > [Report Print] > [OK] key > [▲] [▼] key > [Status Page] > [OK] key > [Yes]

3 Log in with administrator privileges.

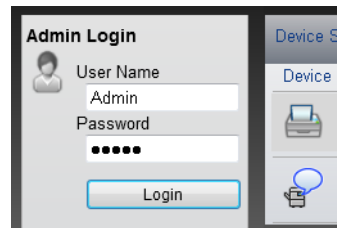

The factory default setting for the default user with administrator privileges is shown below. (Upper case and lower case letters are distinguished (case sensitive).)

Login User Name: Admin

Login Password: Admin

4 Click [Security Settings].

2 Configure the Security Settings.

From the [Security Settings] menu, select the setting you want to configure.

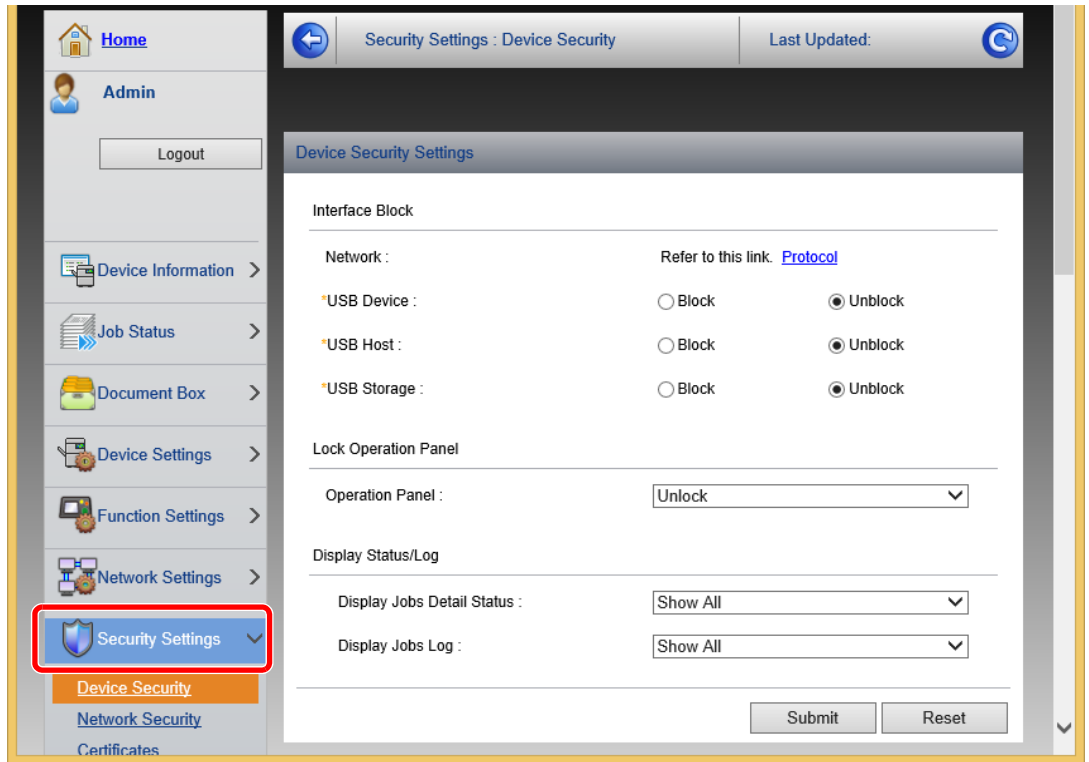

NOTE

For details on settings related to certificates, refer to the following:

➔ **Embedded Web Server RX User Guide**

Changing Device Information

1 Display the screen.

- 1 Launch your Web browser.
- 2 In the address or location bar, enter the machine's IP address or the host name.
Print the status page to check the machine's IP address and the host name.
[Menu] key > [▲] [▼] key > [Report] > [OK] key > [▲] [▼] key > [Report Print] > [OK] key > [▲] [▼] key > [Status Page] > [OK] key > [Yes]
- 3 Log in with administrator privileges.

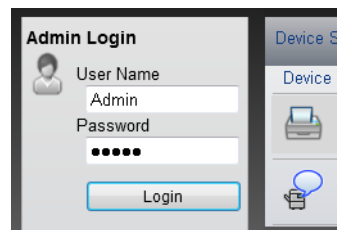

The factory default setting for the default user with administrator privileges is shown below. (Upper case and lower case letters are distinguished (case sensitive).)

Login User Name: Admin
Login Password: Admin

- 4 From the [Device Settings] menu, click [System].

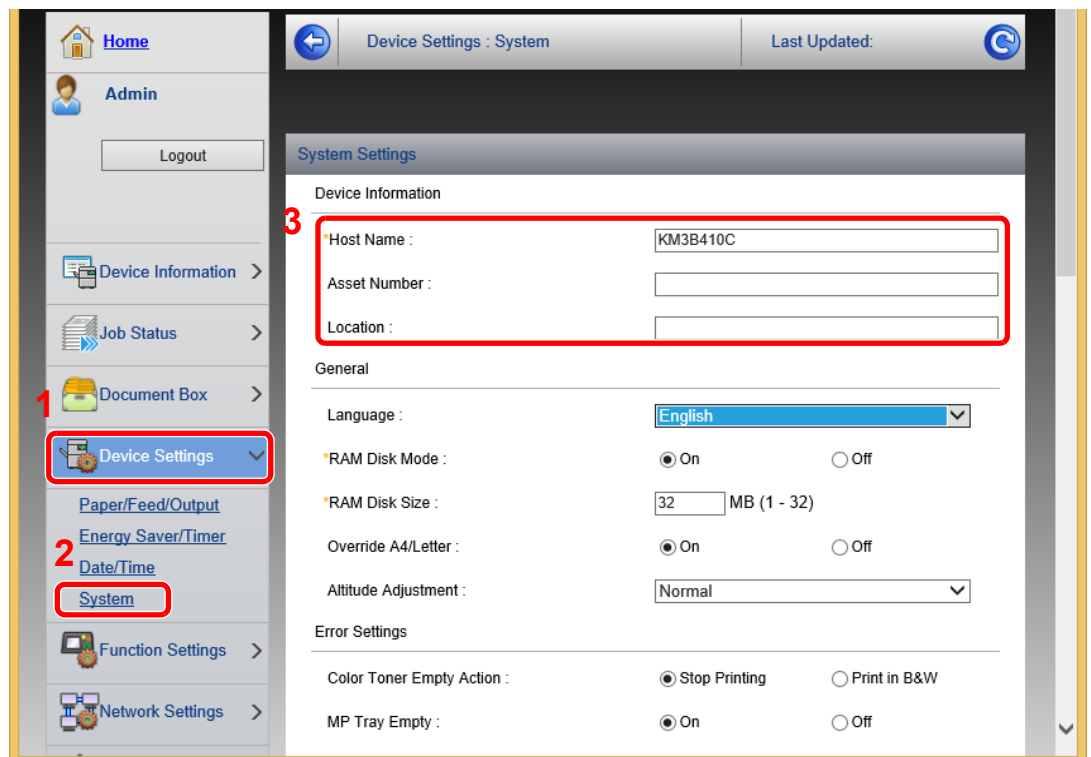

2 Specify the host name.

Enter the device information, and then click **[Submit]**.

 **IMPORTANT**

After changing the setting, restart the network or turn the machine OFF and then ON.

To restart the network interface card, click **[Reset] in the **[Management Settings]** menu, and then click **[Restart Network]** in "Restart".**

E-mail Settings

By configuring the SMTP settings, it is possible to send E-mail notices when jobs have been completed.

To use this function, this machine must be connected to a mail server using the SMTP protocol.

In addition, configure the following.

- SMTP settings
Item: "SMTP Protocol" and "SMTP Server Name" in "SMTP"
- The sender address when the machine sends E-mails
Item: "Sender Address" in "E-mail Send Settings"
- The setting to limit the size of E-mails
Item: "E-mail Size Limit" in "E-mail Send Settings"

The procedure for specifying the SMTP settings is explained below.

1 Display the screen.

Display the SMTP Protocol screen.

1 Launch your Web browser.

2 In the address or location bar, enter the machine's IP address or the host name.

Print the status page to check the machine's IP address and the host name.

[Menu] key > [▲] [▼] key > [Report] > [OK] key > [▲] [▼] key > [Report Print] > [OK] key > [▲] [▼] key > [Status Page] > [OK] key > [Yes]

3 Log in with administrator privileges.

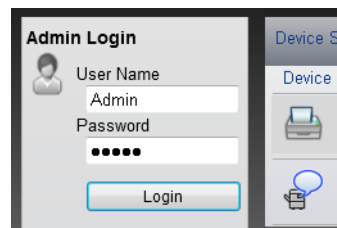

The factory default setting for the default user with administrator privileges is shown below. (Upper case and lower case letters are distinguished (case sensitive).)

Login User Name: Admin

Login Password: Admin

4 From the [Network Settings] menu, click [Protocol].

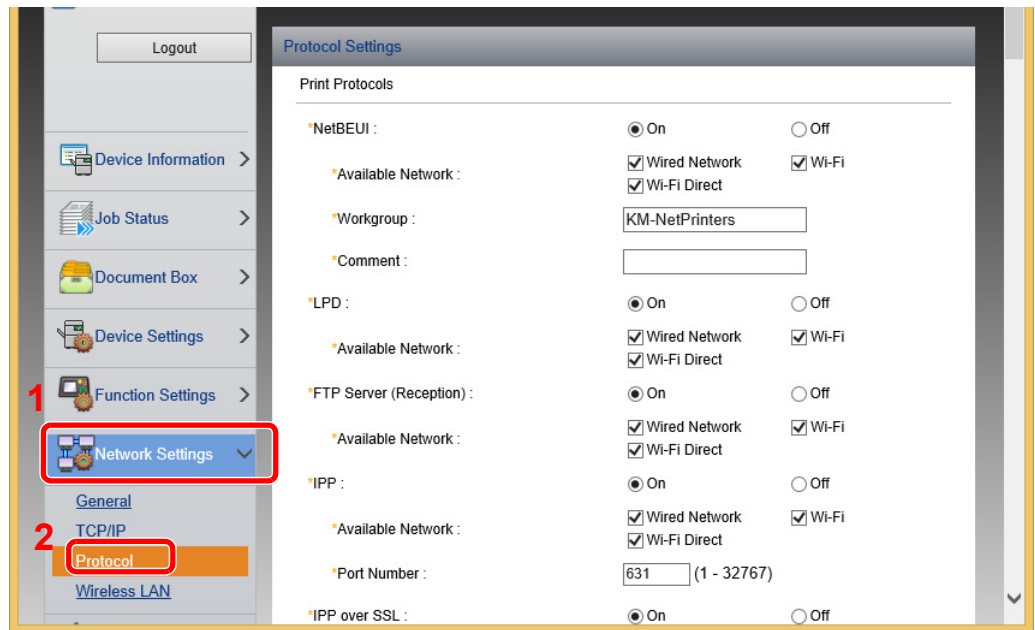

2 Configure the settings.

Set "SMTP (E-mail TX)" to [On] in the "Send Protocols".

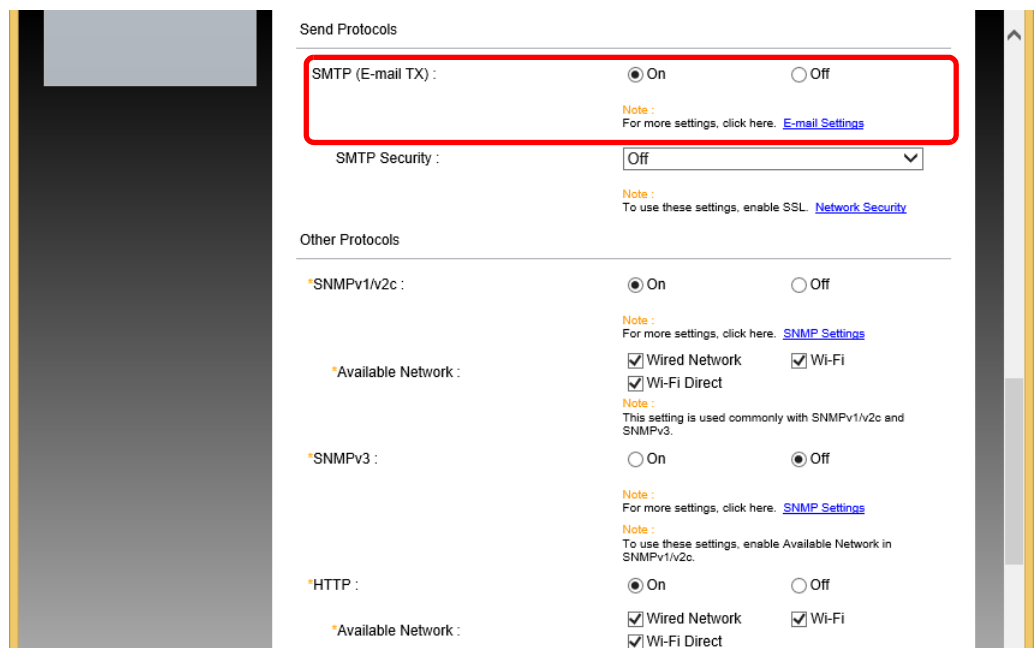

3 Display the screen.

Display the E-mail Settings screen.

From the [Function Settings] menu, click [E-mail].

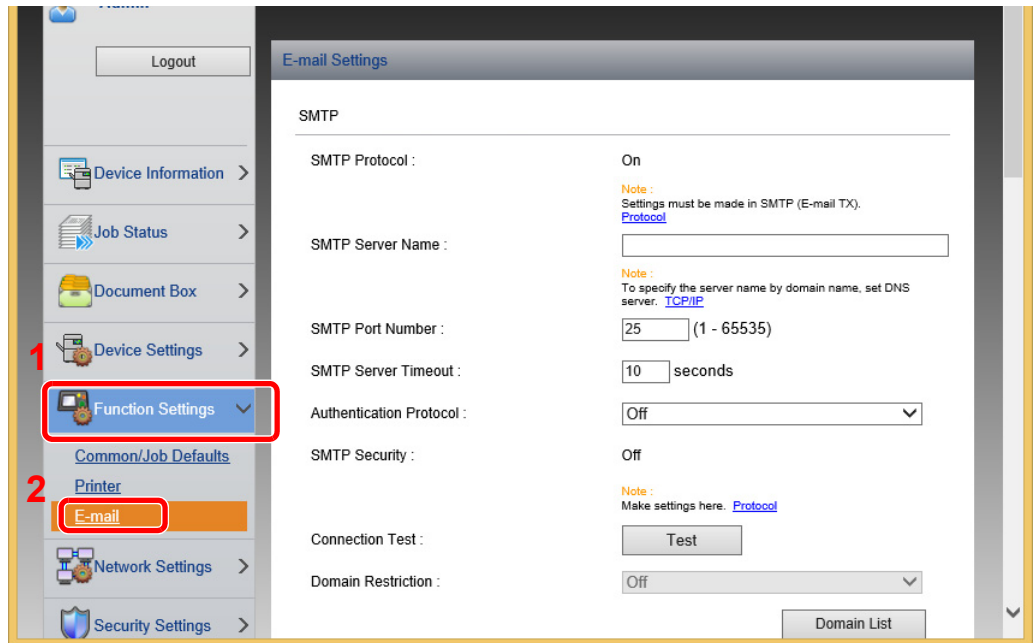

4 Configure the settings.

Enter "SMTP" and "E-mail Send Settings" items.

Setting	Description
SMTP	Set to send e-mail from the machine.
SMTP Protocol	Displays the SMTP protocol settings. Check that "SMTP Protocol" is set to [On] . If [Off] is set, click [Protocol] and set the SMTP protocol to [On] .
SMTP Server Name^{*1}	Enter the host name or IP address of the SMTP server.
SMTP Port Number	Specify the port number to be used for SMTP. Use the SMTP default port 25.
SMTP Server Timeout	Set the amount of time to wait before time-out in seconds.
Authentication Protocol	To use SMTP authentication, enter the user information for authentication.
SMTP Security	Set SMTP security. Turn on "SMTP Security" in "SMTP (E-mail TX)" on the [Protocol Settings] page.
Connection Test	Tests to confirm that the settings are correct.
Domain Restriction	To restrict the domains, click the [Domain List] and enter the domain names of addresses to be allowed or rejected. Restriction can also be specified by e-mail address.
POP3	<p>You don't need to set the following items when you only enable the function of sending e-mail from the machine. Set the following items if you want to enable the function of receiving e-mail on the machine.</p> <p>➡ Embedded Web Server RX User Guide</p>
POP3 Protocol	
Check Interval	
Run once now	
Domain Restriction	
POP3 User Settings	
E-mail Send Settings	
E-mail Size Limit	Enter the maximum size of E-mail that can be sent in kilobytes. When E-mail size is greater than this value, an error message appears and E-mail sending is cancelled. Use this setting if you have set E-mail Size Limit for SMTP server. If not, enter a value of 0 (zero) to enable E-mail sending regardless of the size limit.
Sender Address^{*1}	Specify the sender address for when the machine sends E-mails, such as the machine administrator, so that a reply or non-delivery report will go to a person rather than to the machine. The sender address must be entered correctly for SMTP authentication. The maximum length of the sender address is 128 characters.
Signature	Enter the signature. The signature is free form text that will appear at the end of the E-mail body. It is often used for further identification of the machine. The maximum length of the signature is 512 characters.
Function Defaults	Change the function default settings in [Common/Job Default Settings] page.

*1 Be sure to enter the items.

5 Click **[Submit]**.

Creating a New Custom Box

NOTE

To use Custom Box, an optional SSD must be installed in the machine.

1 Display the screen.

- 1 Launch your Web browser.
- 2 In the address or location bar, enter the machine's IP address or the host name.
Print the status page to check the machine's IP address and the host name.
[Menu] key > [▲] [▼] key > [Report] > [OK] key > [▲] [▼] key > [Report Print] > [OK] key > [▲] [▼] key > [Status Page] > [OK] key > [Yes]
- 3 From the [Document Box] menu, click [Custom Box].

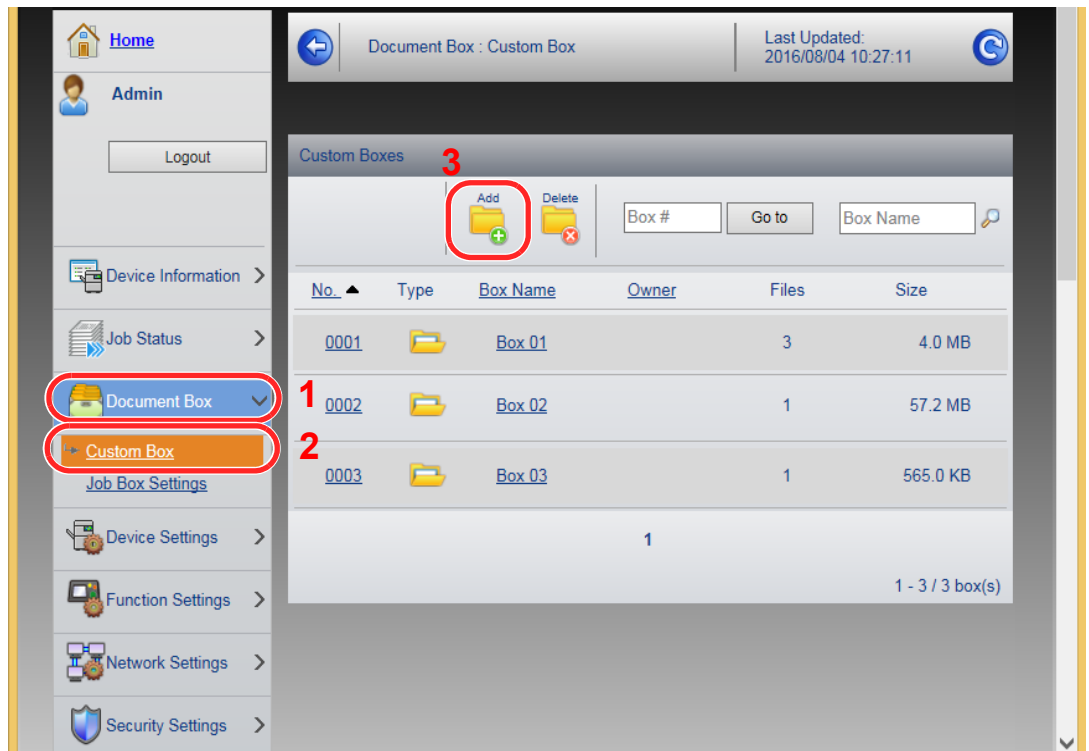

- 4 Click [Add].

2 Configure the Custom Box.

- 1 Enter the box details.
Enter the information for the custom box you want to register. For details on the fields to populate, refer to the following:
➔ [Embedded Web Server RX User Guide](#)
- 2 Click [Submit].

Printing a document stored in a Custom Box

1 Display the screen.

- 1 Launch your Web browser.
- 2 In the address or location bar, enter the machine's IP address or the host name.
Print the status page to check the machine's IP address and the host name.
[Menu] key > [▲] [▼] key > [Report] > [OK] key > [▲] [▼] key > [Report Print] > [OK] key > [▲] [▼] key > [Status Page] > [OK] key > [Yes]
- 3 From the [Document Box] menu, click [Custom Box].

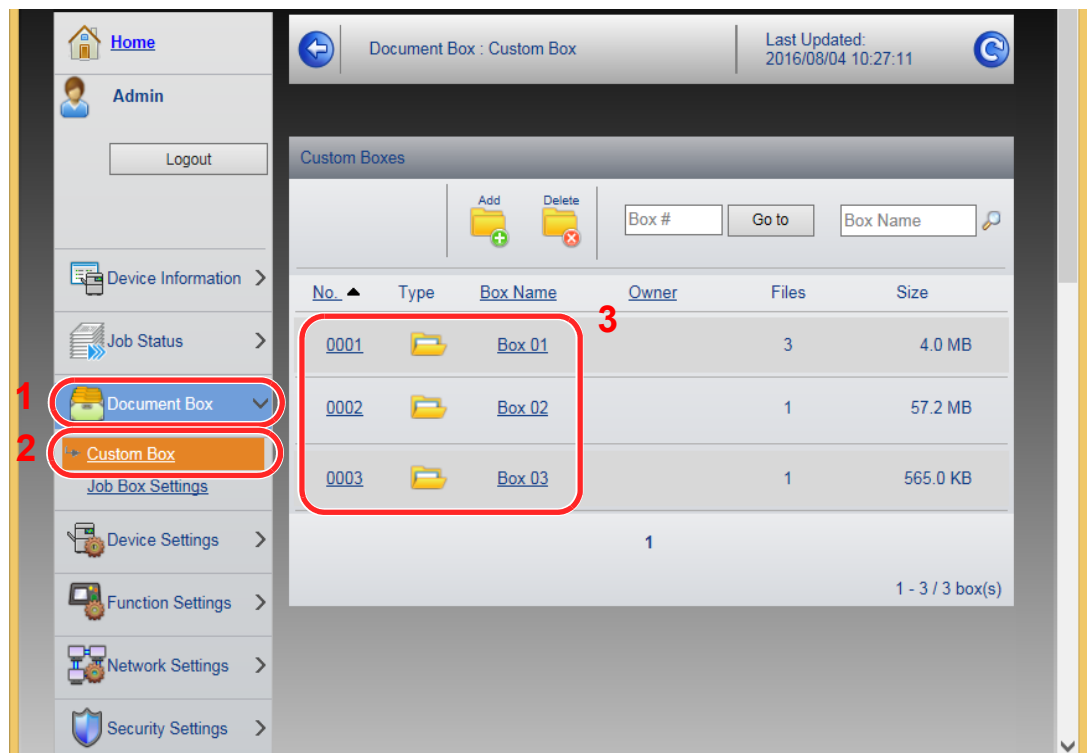

- 4 Click the number or name of the Custom Box in which the document is stored.

2 Print the document.

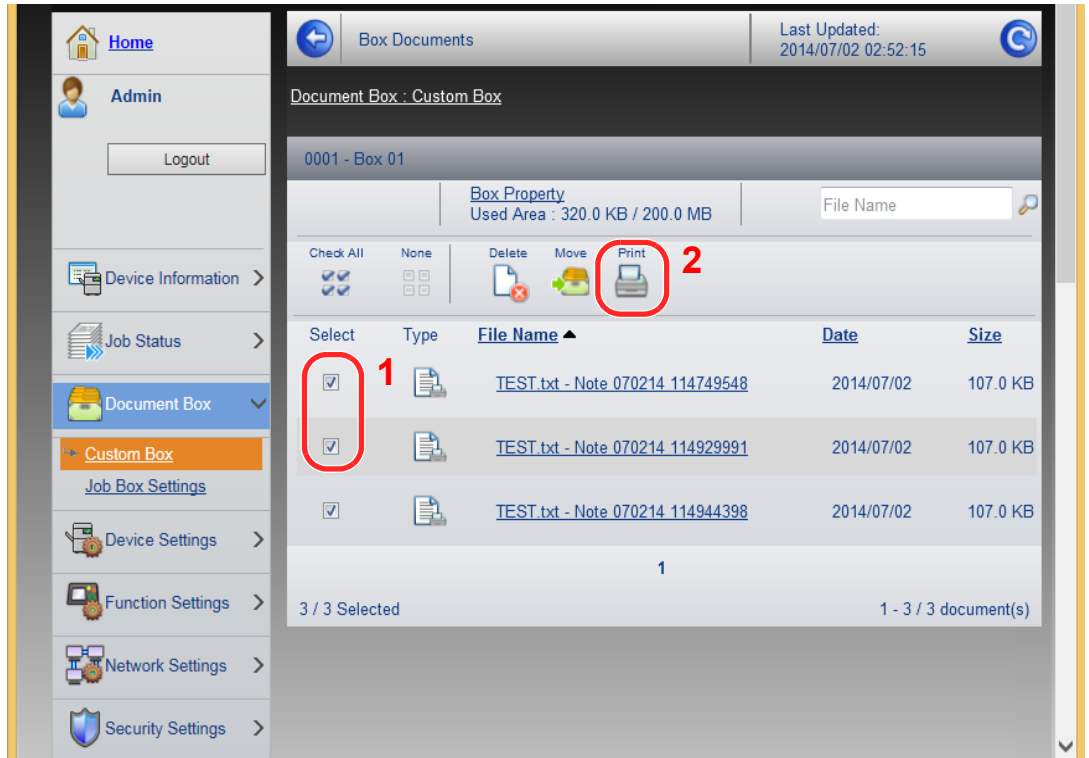

- 1 Select the document you wish to print.
Select the checkbox of the document to be printed.
- 2 Click [**Print**].
- 3 Configure settings for printing, click [**Print**].

3 Preparation before Use

This chapter explains the following operations.

Loading Paper	3-2
Precaution for Loading Paper	3-3
Loading in the Cassettes	3-4
Loading Paper in the Multi Purpose Tray	3-7
Specifying Paper Size and Media Type	3-10
Paper Stopper	3-13

Loading Paper

Load paper in the cassettes and multipurpose tray.

For the paper load methods for each cassette, refer to the page below.

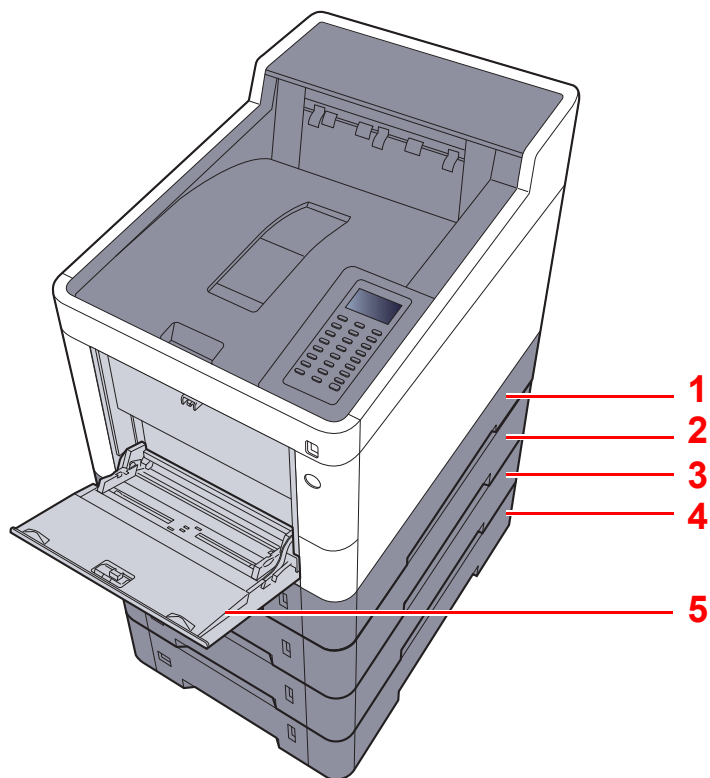

No.	Name	Page
1	Cassette 1	page 3-4
2	Cassette 2	page 3-4
3	Cassette 3	page 3-4
4	Cassette 4	page 3-4
5	Multi Purpose Tray	page 3-7



NOTE

- The number of sheets that can be held varies depending on your environment and paper type.
- You should not use inkjet printer paper or any paper with a special surface coating. (Such paper may cause paper jams or other faults.)
- For higher quality color printing, use special color paper.

Precaution for Loading Paper

When you open a new package of paper, fan the sheets to separate them slightly prior to loading in the following steps.

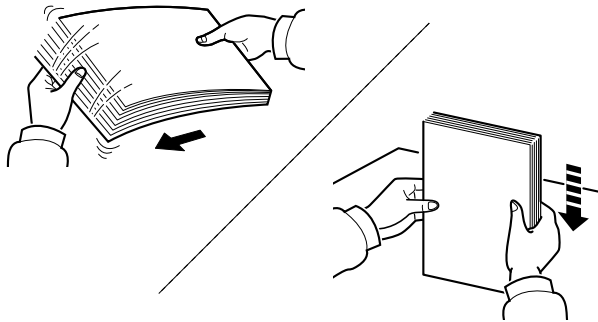

Fan the paper, then tap it on a level surface.

In addition, note the following points.

- If the paper is curled or folded, straighten it before loading. Paper that is curled or folded may cause a jam.
- Avoid exposing opened paper to high temperatures and high humidity as dampness can be a cause of problems. Seal any remaining paper after loading in the multi purpose tray or cassettes back in the paper storage bag.
- If the machine will not be used for a prolonged period, protect all paper from humidity by removing it from the cassettes and sealing it in the paper storage bag.

✔ IMPORTANT

If you print onto used paper (paper already used for printing), do not use paper that is stapled or clipped together. This may damage the machine or cause poor image quality.

💡 NOTE

If you use special paper such as letterhead, paper with holes or paper with pre-prints like logo or company name, refer to the following:

➔ [Paper \(page 11-14\)](#)

Loading in the Cassettes

The cassettes can hold plain paper, recycled paper or color paper.

The number of sheets that can be loaded in each cassette is shown below.

Cassette	No. Sheets
Cassettes 1 to 4	500 sheets (Plain paper: 80 g/m ²)

For details of the supported paper sizes, refer to the following:

➔ [Choosing the Appropriate Paper \(page 11-15\)](#)

NOTE

A6 paper cannot be loaded in cassettes 2 to 4.

For the paper type setting, refer to the following:

➔ [Media Type Setting \(page 8-9\)](#)

IMPORTANT

The cassettes 1 can hold paper with weight between 60 - 163 g/m². The cassettes 2 to 4 can hold paper with weight between 60 - 220 g/m².

1 Pull the cassette completely out of the machine.

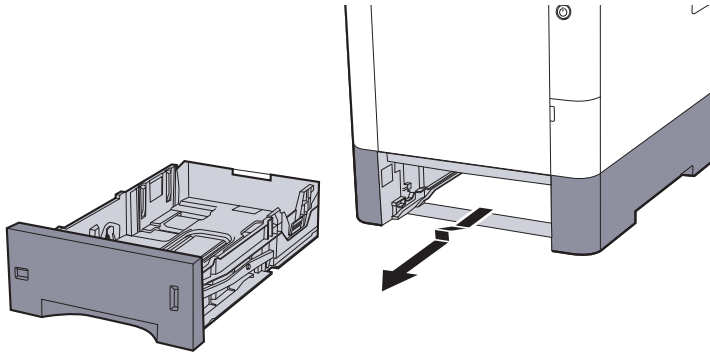

NOTE

When pulling the cassette out of the machine, ensure it is supported and does not fall out.

2 Adjust the cassette size.

- 1 Adjust the position of the paper width guides located on the left and right sides of the cassette. Press the paper width adjusting tab and slide the guides to the paper size required. Paper sizes are marked on the cassette.

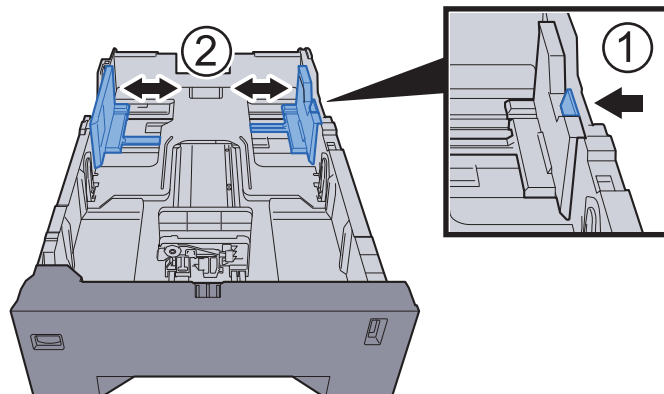

- 2 Adjust the paper length guide to the paper size required. Press the paper length adjusting tab and slide the guides to the paper size required.

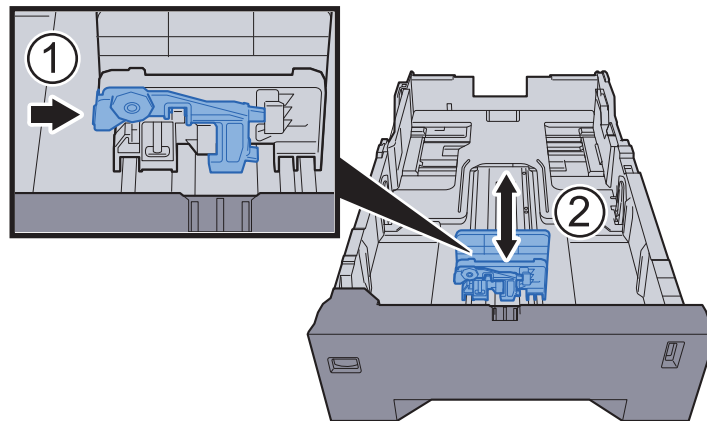

- 3 Turn the size dial so that the size of the paper you are going to use appears in the paper size window.

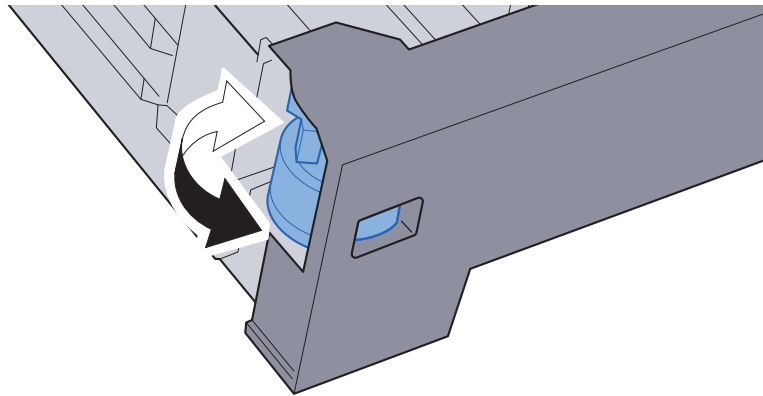

 **NOTE**

When the size dial is set to "Other" the paper size must be set into the machine on the operation panel.

➔ [Paper Size and Media Type for the Cassettes \(page 3-10\)](#)

3 Load paper.

- 1 Fan the paper, then tap it on a level surface to avoid paper jams or skewed printing.
- 2 Load the paper in the cassette.

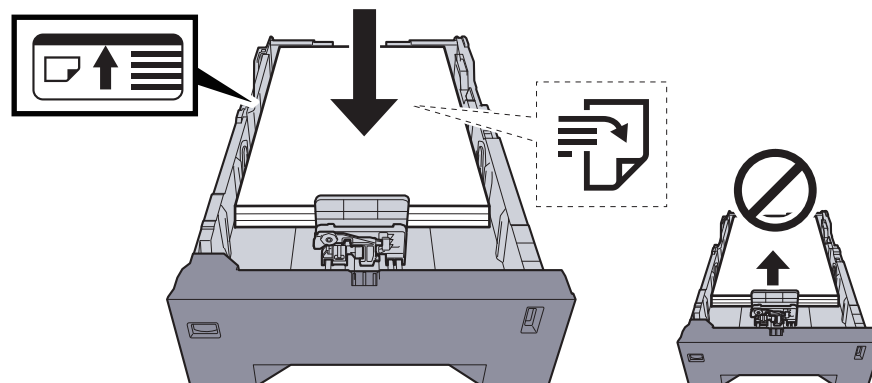

✔ **IMPORTANT**

- Load the paper with the print side facing up.
- After removing new paper from its packaging, fan the paper before loading it in the multi-purpose tray.
- ➔ [Precaution for Loading Paper \(page 3-3\)](#)
- Before loading the paper, be sure that it is not curled or folded. Paper that is curled or folded may cause paper jams.
- Ensure that the loaded paper does not exceed the level indicator (see illustration above).
- If paper is loaded without adjusting the paper length guide and paper width guide, the paper may skew or become jammed.

4 Gently push the cassette back in.

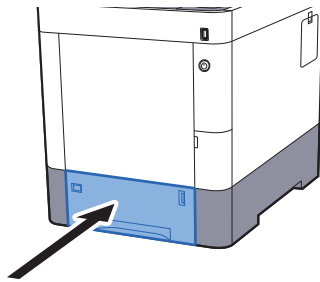

NOTE

There is a paper gauge on the right side of the front of the cassette to indicate the remaining paper supply.

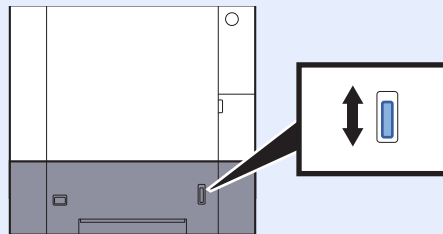

5 Specify the type of paper loaded in the cassette using the operation panel.

- ➔ [Paper Size and Media Type for the Cassettes \(page 3-10\)](#)

Loading Paper in the Multi Purpose Tray

The multi purpose tray will hold up to 100 sheets of plain paper (80 g/m²).

For details of the supported paper sizes, refer to the following:

➔ [Choosing the Appropriate Paper \(page 11-15\)](#)

For the paper type setting, refer to the following:

➔ [Media Type Setting \(page 8-9\)](#)

Be sure to use the multi purpose tray when you print on any special paper.

✔ IMPORTANT

- If you are using a paper weight of 106 g/m² or more, set the media type to Thick and set the weight of the paper you are using.
- Remove each transparency from the top tray as it is printed. Leaving transparencies in the top tray may cause a paper jam.

The capacity of the multi purpose tray is as follows.

- Plain paper (80 g/m²), recycled paper or color paper: 100 sheets
- Thick paper (209 g/m²): 15 sheets
- Thick paper (157 g/m²): 30 sheets
- Thick paper (104.7 g/m²): 50 sheets
- Hagaki (Cardstock): 30 sheets
- Envelope DL, Envelope C5, Envelope #10, Envelope #9, Envelope #6 3/4, Envelope Monarch, Youkei 4, Youkei 2: 5 sheets
- OHP film: 1 sheet
- Coated: 30 sheets

💡 NOTE

- When you load custom size paper, enter the paper size by referring to the following:
➔ [Paper Size and Media Type for the Multi Purpose Tray \(MP Tray Setting\) \(page 3-12\)](#)
- When you use special paper such as transparencies or thick paper, select the media type by referring to the following:
➔ [Paper Size and Media Type for the Multi Purpose Tray \(MP Tray Setting\) \(page 3-12\)](#)

1 Open the multi purpose tray.

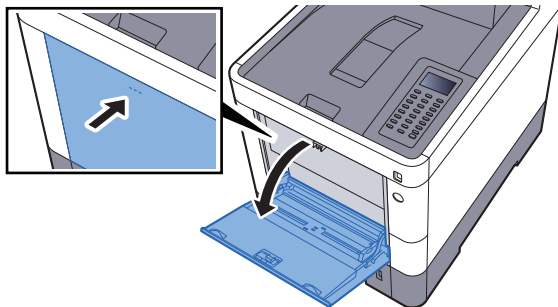

2 Adjust the multi purpose tray size.

Paper sizes are marked on the multi purpose tray.

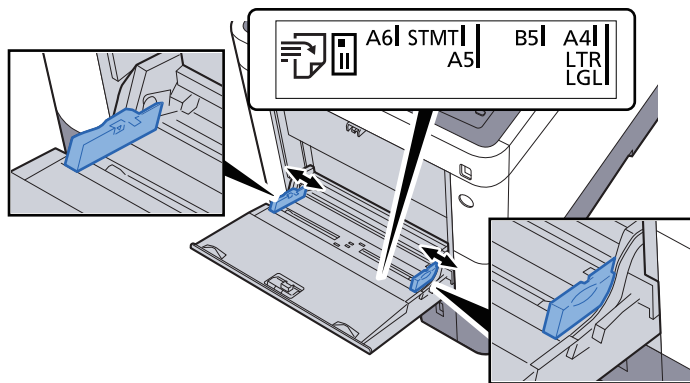

3 Load paper.

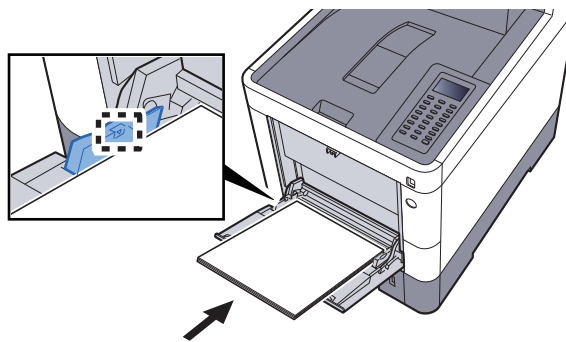

Insert the paper along the paper width guides into the tray until it stops.

After removing new paper from its packaging, fan the paper before loading it in the multi purpose tray.

➔ [Precaution for Loading Paper \(page 3-3\)](#)

✔ IMPORTANT

- When loading the paper, keep the print side facing up.
- Curled paper must be uncurled before use.
- When loading paper into the multi purpose tray, check that there is no paper left over in the tray from a previous job before loading the paper. If there is just a small amount of paper left over in the multi purpose tray and you want to add more, first remove the left-over paper from the tray and include it with the new paper before loading the paper back into the tray.
- If there is a gap between the paper and the paper width guides, readjust the guides to fit the paper in order to prevent skewed feeding and paper jams.
- Ensure that the loaded paper does not exceed the load limits.

4 Specify the type of paper loaded in the multi purpose tray using the operation panel.

➔ [Paper Size and Media Type for the Multi Purpose Tray \(MP Tray Setting\) \(page 3-12\)](#)

When you load envelopes or cardstock in the multi purpose tray

Load the paper with the print side facing up. For the procedure for printing, refer to the following:

➔ **Printing System Driver User Guide**

Example: When printing the address.

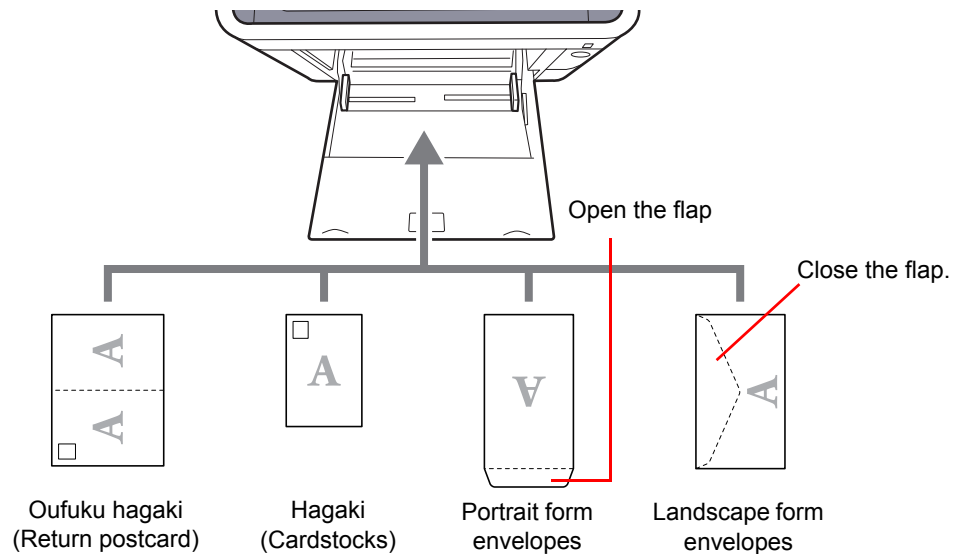

✔ **IMPORTANT**

- Use unfolded Oufuku hagaki (Return postcard).
- How to load envelopes (orientation and facing) will differ depending on the type of envelope. Be sure to load it in correctly, otherwise printing may be done in the wrong direction or on the wrong face.

💡 **NOTE**

When you load envelopes in the multi purpose tray, select the envelope type by referring to the following:

- ➔ [Paper Size and Media Type for the Multi Purpose Tray \(MP Tray Setting\) \(page 3-12\)](#)

Specifying Paper Size and Media Type

The default paper size setting for cassette 1, for the multi purpose tray and for the optional paper feeder (cassettes 2 to 4) is "A4" or "Letter", and the default media type setting is "Plain".

To change the type of paper to be used in cassettes, specify the paper size and media type setting.

Paper Size and Media Type for the Cassettes

Specify the paper size and media type of paper to be used in cassettes.

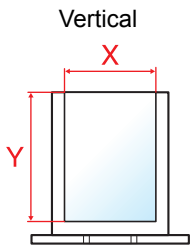
Item	Description
Media Type^{*1}	Select the media type. Values Cassette 1: Plain (60 - 105 g/m²), Preprinted, Bond, Recycled, Vellum (60 - 105 g/m²), Rough, Letterhead, Color, Prepunched, Thick (106 - 163 g/m²), High Quality, CUSTOM 1 - 8 Cassette 2 to 4: Plain (60 - 105 g/m²), Preprinted, Labels, Bond, Recycled, Vellum (60 - 105 g/m²), Rough, Letterhead, Color, Prepunched, Envelope, Coated, Thick (106 - 220 g/m²), High Quality, CUSTOM 1 - 8
Other Paper Size	Available options are as follows: Values Cassette 1: Executive, Letter, Legal, A4, B5, A5, A6, B6, ISO B5, Custom, Oficio II, 216 × 340 mm, 16K, Statement, Folio Cassette 2 to 4: Envelope Monarch, Envelope #10, Envelope DL, Envelope C5, Executive, Letter, Legal, A4, B5, A5, B6, Envelope #9, Envelope #6, ISO B5, Custom, Oficio II, 216 × 340 mm, 16K, Statement, Folio, Youkei 2, Youkei 4
Custom PaperSize^{*2}	Register the custom paper size to be used in Cassettes 1 to 4. Values Cassette 1: Metric X: 105 to 216 mm (in 1 mm increments) Y: 148 to 356 mm (in 1 mm increments) Inch X: 4.13 to 8.50" (in 0.01" increments) Y: 5.83 to 14.02" (in 0.01" increments) Cassette 2 to 4: Metric X: 92 to 216 mm (in 1 mm increments) Y: 162 to 356 mm (in 1 mm increments) Inch X: 3.62 to 8.50" (in 0.01" increments) Y: 6.38 to 14.02" (in 0.01" increments) X=Length, Y=Width <div style="text-align: center;">  </div>

*1 To change to a media type other than "Plain".

➔ [Media Type Setting \(page 8-9\)](#)

When a paper weight that cannot be loaded in the cassette is set for a media type, that media type does not appear.

*2 Appears when [Custom] is selected in Other Paper Size.

Paper Size and Media Type for the Cassettes:

If the size dial is set to one of the sizes below, set the media type.

"A4", "A5", "B5", "Letter", "Legal" or "A6" (Cassette 1 only)

If the size dial is set to "Other", configure the settings for the paper size and the media type.

1 Display the screen.

[Menu] key > [▲] [▼] key > [Paper Settings] > [OK] key > [▲] [▼] key > [Cassette 1 (to 4) Set.] > [OK] key



NOTE

[Cassette 2] to [Cassette 4] are shown when the optional paper feeder is installed.

2 Specify the media type.

1 [▲] [▼] key > [Media Type] > [OK] key

2 Select the media type, and select the [OK] key.

3 Specify the paper size.

1 [▲] [▼] key > [Other Paper Size] > [OK] key

2 Select the paper size, and select the [OK] key.

If you selected [Custom], use the procedure below to specify the paper length and width.

3 [▲] [▼] key > [Custom PaperSize] in "Cassette 1 (to 4) Set." > [OK] key > [▲] [▼] key > [Measurement] > [OK] key

4 Select the paper size units, and select the [OK] key.

5 [▲] [▼] key > [Size Entry(Y)] > [OK] key

6 Enter the paper length, and select the [OK] key.



NOTE

Use the numeric keys or select the [▲] or [▼] key to enter a number.

7 [▲] [▼] key > [Size Entry(X)] > [OK] key

8 Enter the paper width, and select the [OK] key.



NOTE

Use the numeric keys or select the [▲] or [▼] key to enter a number.

Paper Size and Media Type for the Multi Purpose Tray (MP Tray Setting)

Specify the paper size and media type of paper to be used in the multi purpose tray.

Item	Description
Paper Size	Available options are as follows: Values: Envelope Monarch, Envelope #10, Envelope DL, Envelope C5, Executive, Letter, Legal, A4, B5, A5, A6, B6, Envelope #9, Envelope #6, ISO B5, Custom, Hagaki (Cardstock), Oufuku hagaki (Return postcard), Oficio II, 216 × 340 mm, 16K, Statement, Folio, Youkei 2, Youkei 4
Media Type ^{*1}	Select the media type. Values: Plain (60 - 105 g/m ²), Transparency, Preprinted, Labels, Bond, Recycled, Vellum (60 - 105 g/m ²), Rough, Letterhead, Color, Prepunched, Envelope, Cardstock, Coated, Thick (106 - 220 g/m ²), High Quality, Custom 1 - 8

*1 To change to a media type other than Plain.

➔ [Media Type Setting \(page 8-9\)](#)

1 Display the screen.

[Menu] key > [▲] [▼] key > [Paper Settings] > [OK] key > [▲] [▼] key > [MP Tray Set.] > [OK] key

2 Specify the paper size.

1 [▲] [▼] key > [Paper Size] > [OK] key

2 Select the paper size, and select the [OK] key.

3 Specify the media type.

1 [▲] [▼] key > [Media Type] > [OK] key

2 Select the media type, and select the [OK] key.

Paper Stopper

When using paper A4/Letter or larger, open the paper stopper shown in the figure.

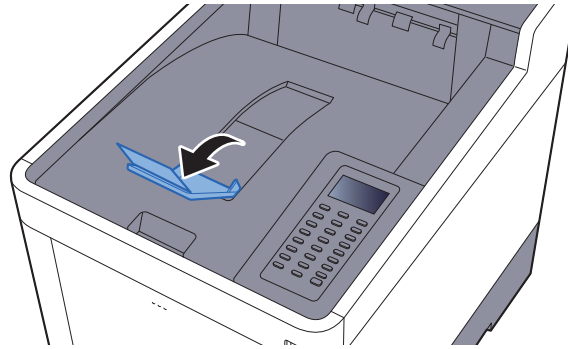

4 Printing from PC

This chapter explains the following topics:

Printing from PC	4-2
Printing on Non-standard Sized Paper	4-4
Printer Driver Print Settings Screen	4-5
Printer Driver Help	4-6
Changing the Default Printer Driver Settings (Windows 8.1)	4-6
Canceling Printing from a Computer	4-6
Printing by AirPrint	4-7
Printing by Google Cloud Print	4-7
Printing by Mopria	4-7
Printing with Wi-Fi Direct	4-7
Printing Data Saved on the Printer	4-8
Specifying the Job Box from a Computer and Storing the Job	4-8
Printing Documents from Private Print Box	4-9
Printing Document from Stored Job Box	4-11
Printing Document from Quick Copy Box	4-13
Printing Document from Proof and Hold Box	4-15
Job Box Setting	4-17
Status Monitor	4-18
Accessing the Status Monitor	4-18
Exiting the Status Monitor	4-18
Status Monitor Display	4-18

Printing from PC

Follow the steps below to print documents from applications.

NOTE

- To print the document from applications, install the printer driver on your computer from the supplied DVD (Product Library).
- In some environments, the current settings are displayed at the bottom of the printer driver.

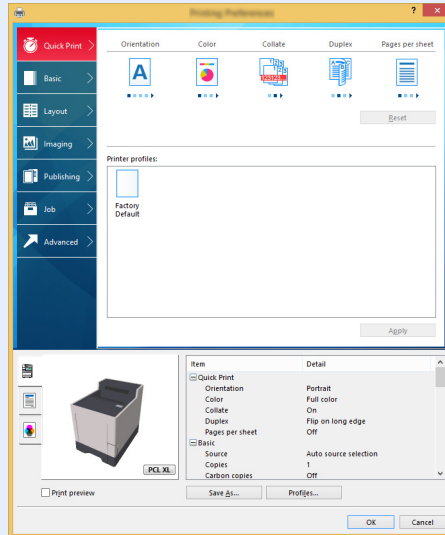

- When printing the cardstock or envelopes, load the cardstock or envelopes in the multi purpose tray before performing the following procedure.

➔ [When you load envelopes or cardstock in the multi purpose tray \(page 3-9\)](#)

1 Display the screen.

Click [File] and select [Print] in the application.

2 Configure the settings.

- 1 Select the machine from the "Printer" menu and click the [Properties] button.

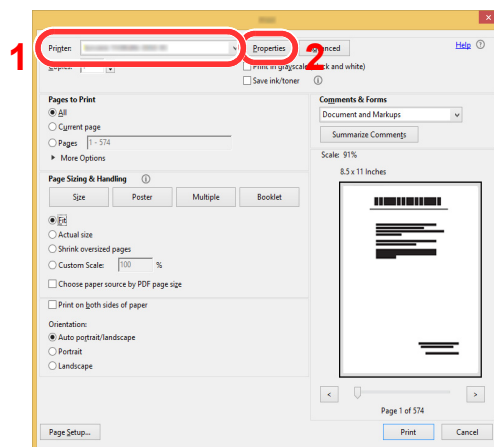

2 Select the **[Basic]** tab.

3 Click "Print size" menu and select the paper size to use for printing.

To load the paper of size that is not included in print sizes of the machine such as cardstock or envelopes, the paper size needs to be registered.

➔ [Printing on Non-standard Sized Paper \(page 4-4\)](#)

To print on the special paper such as thick paper or transparency, click "Media type" menu and select the media type.

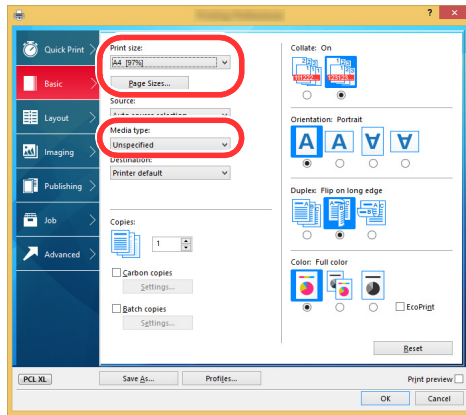

4 Click **[OK]** button to return to the Print dialog box.

3 Start printing.

Click the **[OK]** button.

Printing on Non-standard Sized Paper

If you loaded a paper size that is not included in the print sizes of the machine, register the paper size in the **[Basic]** tab of the print settings screen of the printer driver.

The registered size can be selected from the "Print size" menu.

NOTE

To execute printing at the machine, set the paper size and type in the following:

➔ [Paper Size and Media Type for the Multi Purpose Tray \(MP Tray Setting\) \(page 3-12\)](#)

1 Display the print settings screen.

2 Register the paper size.

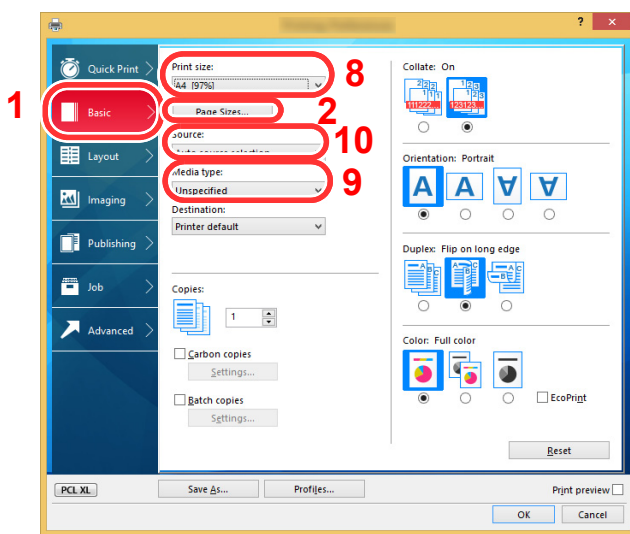

- 1 Click the **[Basic]** tab.
- 2 Click the **[Page Size...]** button.
- 3 Click the **[New]** button.
- 4 Enter the paper size.
- 5 Enter the name of the paper.
- 6 Click the **[Save]** button.
- 7 Click the **[OK]** button.
- 8 In the "Print size" menu, select the paper size (name) that you registered in steps 4 to 7.
- 9 Select the type of paper in the "Media type" menu.
- 10 Click **[MP tray]** in the "Source" menu.

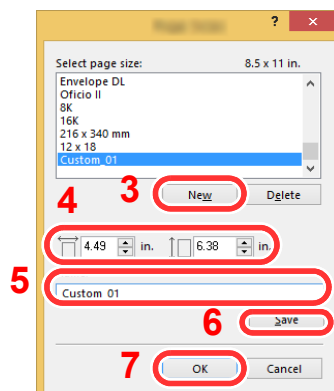

NOTE

If you loaded a postcard or envelope, select **[Cardstock]** or **[Envelope]** in the "Media type" menu.

Printer Driver Print Settings Screen

The printer driver print settings screen allows you to configure a variety of print-related settings.

➔ **Printing System Driver User Guide**

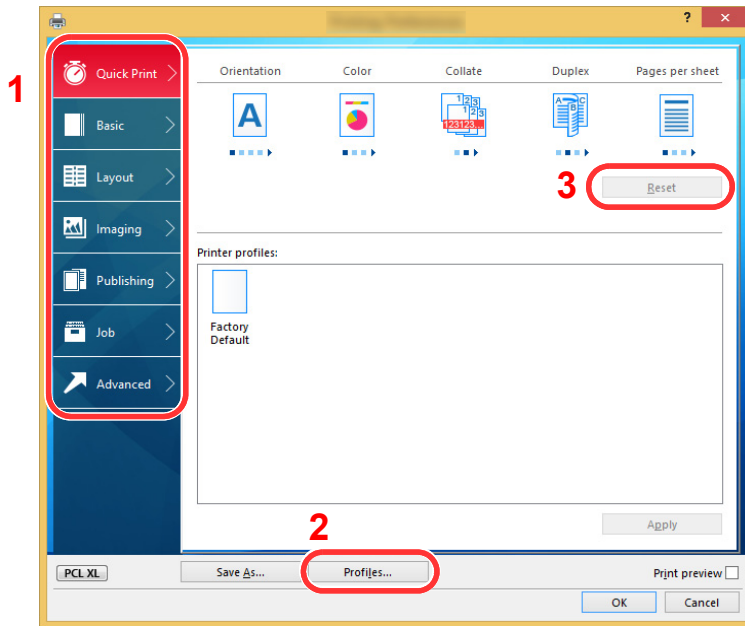

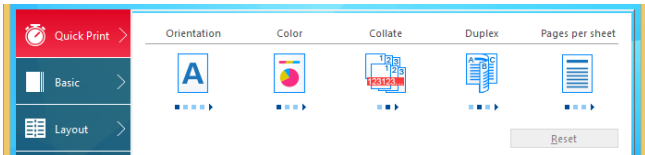
No.	Description
1	<p>[Quick Print] tab Provides icons that can be used to easily configure frequently used functions. Each time you click an icon, it changes to an image resembling the print results and applies the settings.</p>  <p>[Basic] tab This tab groups basic functions that are frequently used. You can use it to configure the paper size, and duplex printing.</p> <p>[Layout] tab This tab lets you configure settings for printing various layouts, including booklet printing, combine mode, poster printing, and scaling.</p> <p>[Imaging] tab This tab lets you configure settings related to the quality of the print results.</p> <p>[Publishing] tab This tab lets you create covers and inserts for print jobs and put inserts between sheets of OHP film.</p> <p>[Job] tab This tab lets you configure settings for saving print data from the computer to the machine. Regularly used documents and other data can be saved to the machine for easy printing later. Since saved documents can be printed directly from the machine, this function is also convenient when you wish to print a document that you don't want others to see.</p> <p>[Advanced] tab This tab lets you configure settings for adding text pages or watermarks to print data.</p>
2	<p>[Profiles] Printer driver settings can be saved as a profile. Saved profiles can be recalled at any time, so it's a convenient practice to save frequently used settings.</p>
3	<p>[Reset] Click to revert settings to their initial values.</p>

Printer Driver Help

The printer driver includes Help. To learn about print settings, open the printer driver print settings screen and display Help as explained below.

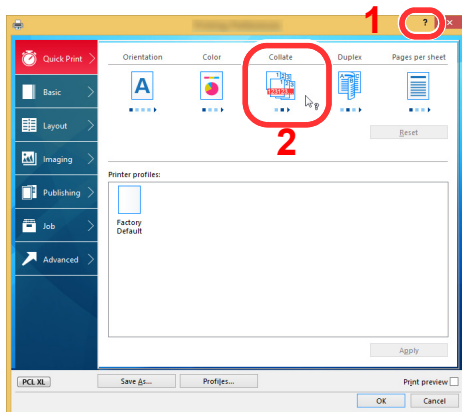

- 1 Click the [?] button in the upper right corner of the screen and then click the item you want to know about.
- 2 Click the item you want to know about and press the [F1] key on your keyboard.

Changing the Default Printer Driver Settings (Windows 8.1)

The default printer driver settings can be changed. By selecting frequently used settings, you can omit steps when printing. For the settings, refer to the following:

➔ Printing System Driver User Guide

- 1 In charms on Desktop, click [Settings], [Control Panel], and then [Devices and Printers].
- 2 Right-click the printer driver icon of the machine, and click the [Printer properties] menu of the printer driver.
- 3 Click the [Basic] button on the [General] tab.
- 4 Select the default settings and click the [OK] button.

Canceling Printing from a Computer

To cancel a print job executed using the printer driver before the printer begins printing, do the following:



NOTE

When canceling printing from this machine, refer to the following:

➔ [Canceling Jobs \(page 5-2\)](#)

- 1 Double-click the printer icon () displayed on the taskbar at the bottom right of the Windows desktop to display a dialog box for the printer.
- 2 Click the file for which you wish to cancel printing and select [Cancel] from the "Document" menu.

Printing by AirPrint

AirPrint is a printing function that is included standard in iOS 4.2 and later products, and Mac OS X 10.7 and later products.

This function enables you to connect and print to any AirPrint compatible device without installing a printer driver.

To allow the machine to be found when printing by AirPrint, you can set machine location information in Embedded Web Server RX.

➔ [Embedded Web Server RX User Guide](#)



Printing by Google Cloud Print

Google Cloud Print is a printing service provided by Google and does not require a printer driver. This service enables a user with a Google account to print from a machine connected to the Internet.

The machine can be configured in the Embedded Web Server RX.

➔ [Embedded Web Server RX User Guide](#)

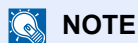

NOTE

A Google account is necessary to use Google Cloud Print. Obtain a Google account if you do not have one.

It is also necessary to register the machine with the Google Cloud Print service in advance. The machine can be registered from a PC connected to the same network.

Printing by Mopria

Mopria is a standard on printing function included in Android 4.4 or later products. Mopria Print Service needs to be installed and enabled in advance.

For details on how to use, refer to a Web site of Mopria Alliance.

Printing with Wi-Fi Direct

Wi-Fi Direct is a wireless LAN standard that Wi-Fi Alliance has been established. This is one of the functions of the wireless LAN, without a wireless LAN access point or wireless LAN router, between devices can communicate directly on a peer to peer basis.

The printing procedure by the Wi-Fi Direct is the same as that from the normal handheld devices.

When you use a printer name or Bonjour name on the port settings of the printer property, you can print the job by specifying the name at Wi-Fi Direct connection.

When you use an IP address for the port, specify the IP address of this machine.

Printing Data Saved on the Printer

If you configure settings in the **[Job]** tab of the printer driver and then print, the print job will be saved in the Job Box (memory) and printing can be executed at the machine.

Follow the work flow below when using Job Box.

Specifying the Job Box from a computer and sending the print job. ([page 4-8](#))



Using the operation panel to specify a file within a Box and printing it.

You can print the documents from the following boxes.

- ➔ [Printing Documents from Private Print Box \(page 4-9\)](#)
- ➔ [Printing Document from Stored Job Box \(page 4-11\)](#)
- ➔ [Printing Document from Quick Copy Box \(page 4-13\)](#)
- ➔ [Printing Document from Proof and Hold Box \(page 4-15\)](#)

Specifying the Job Box from a Computer and Storing the Job

Use the procedure below to store data in a Job Box.

- 1** Click **[File]** and select **[Print]** in the application. The Print dialog box displays.
- 2** Select the machine from the "Name" menu.
- 3** Click the **[Properties]** button. The Properties dialog box displays.
- 4** Click the **[Job]** tab and select the **[Job storage (e-MPS)]** check box to set the function.



NOTE

- To use Stored Job Box and Quick Copy Box, an optional SSD must be installed in the machine.
- For information on how to use the printer driver software, refer to the following:

➔ **Printing System Driver User Guide**

Printing Documents from Private Print Box

In Private Printing, you can specify that a job is not to be printed until you operate the machine. When sending the job from the application software, specify a 4-digit access code in the printer driver. The job is released for printing by entering the access code on the operation panel, ensuring confidentiality of the print job. The data will be deleted upon completion of the print job or after the power switch is turned off.

The following operations are possible:

- ➔ [Printing the Documents \(page 4-9\)](#)
- ➔ [Deleting the Documents \(page 4-10\)](#)

Printing the Documents

Print the documents stored in a Private Print box. The procedure is as follows.

1 Display the screen.

- 1 [Document Box] key > [▲] [▼] key > [Private/Stored] > [OK] key

NOTE

If the default screen of the box is set to a Custom Box, display the Job Box screen.

[Document Box] key > [Back] key > [▲] [▼] key > [Job Box] > [OK] key

- 2 Select the creator of the document, and select the [OK] key.

2 Print the document.

- 1 Select the document to print, and [Select] > [OK] key.

The file is selected. A checkmark will be placed on the right of the selected file.

Checkmarks will be placed on the right of the all files when [All Files] is selected.

When all files are checked, all checkmarked files are deselected.

Select the checkmarked file and select [Select] again to cancel the selection.

- 2 [▲] [▼] key > [Print] > [OK] key
- 3 Specify the number of copies to print as desired, and the [OK] key > [Yes].

Printing starts.

Upon completion of printing, the Private/Stored job is automatically deleted.

NOTE

If the document is protected by an access code, the password entry screen will be displayed. Enter the password using the numeric keys.

Deleting the Documents

Delete the documents stored in a Private Print box. The procedure is as follows.

1 Display the screen.

- 1 [Document Box] key > [▲] [▼] key > [Private/Stored] > [OK] key



NOTE

If the default screen of the box is set to a Custom Box, display the Job Box screen.

[Document Box] key > [Back] key > [▲] [▼] key > [Job Box] > [OK] key

- 2 Select the creator of the document, and select the [OK] key.

2 Delete the document.

- 1 Select the document to delete, and [Select] > [OK] key.

The file is selected. A checkmark will be placed on the right of the selected file.

Checkmarks will be placed on the right of the all files when [All Files] is selected.

When all files are checked, all checkmarked files are deselected.

Select the checkmarked file and select [Select] again to cancel the selection.

- 2 [▲] [▼] key > [Delete] > [OK] key > [Yes]

The document is deleted.



NOTE

If the document is protected by an access code, the password entry screen will be displayed. Enter the password using the numeric keys.

Printing Document from Stored Job Box

In Stored Job, the print data sent from the application is saved to the machine. You can set up an access code as necessary. If you set up an access code, enter the access code when printing. Print data will be stored in the Stored Job Box after printing. This will allow printing of the same print data repeatedly.

The following operations are possible:

- ➔ [Printing the Documents \(page 4-11\)](#)
- ➔ [Deleting the Documents \(page 4-12\)](#)

Printing the Documents

Print the documents stored in a Stored Job box. The procedure is as follows.

1 Display the screen.

- 1 [Document Box] key > [▲] [▼] key > [Private/Stored] > [OK] key

 **NOTE**

If the default screen of the box is set to a Custom Box, display the Job Box screen.

[Document Box] key > [Back] key > [▲] [▼] key > [Job Box] > [OK] key

- 2 Select the creator of the document, and select the [OK] key.

2 Print the document.

- 1 Select the document to print, and [Select] > [OK] key.

The file is selected. A checkmark will be placed on the right of the selected file.

Checkmarks will be placed on the right of the all files when [All Files] is selected.

When all files are checked, all checkmarked files are deselected.

Select the checkmarked file and select [Select] again to cancel the selection.

- 2 [▲] [▼] key > [Print] > [OK] key
- 3 Specify the number of copies to print as desired, and the [OK] key > [Yes].

Printing starts.

 **NOTE**

If the document is protected by an access code, the password entry screen will be displayed. Enter the password using the numeric keys.

Deleting the Documents

Delete the documents stored in a Stored Job box. The procedure is as follows.

1 Display the screen.

- 1 [Document Box] key > [▲] [▼] key > [Private/Stored] > [OK] key

 **NOTE**

If the default screen of the box is set to a Custom Box, display the Job Box screen.

[Document Box] key > [Back] key > [▲] [▼] key > [Job Box] > [OK] key

- 2 Select the creator of the document, and select the [OK] key.

2 Print and delete the document.

- 1 Select the document to delete, and [Select] > [OK] key.

The file is selected. A checkmark will be placed on the right of the selected file.

Checkmarks will be placed on the right of the all files when [All Files] is selected.

When all files are checked, all checkmarked files are deselected.

Select the checkmarked file and select [Select] again to cancel the selection.

- 2 [▲] [▼] key > [Delete] > [OK] key > [Yes]

The document is deleted.

 **NOTE**

If the document is protected by an access code, the password entry screen will be displayed. Enter the password using the numeric keys.

Printing Document from Quick Copy Box

Quick Copy feature facilitates additional prints of a document already printed. Activating Quick Copy and printing a document using the printer driver allow the print data to be stored in the Quick Copy Job Box. When additional copies are required, you can reprint the required number of copies from the operation panel. By default, up to 32 documents can be stored. When power is turned off, all stored jobs will be deleted.

NOTE

- When the number of jobs reaches the limit, the oldest job will be overwritten by the new one.
- To maintain free space on the box, you can set the maximum number of stored jobs.

➔ [Quick Copy Jobs \(page 4-17\)](#)

The following operations are possible:

➔ [Printing the Documents \(page 4-13\)](#)

➔ [Deleting the Documents \(page 4-14\)](#)

Printing the Documents

You can print the documents stored in the Quick Copy box. The procedure is as follows.

1 Display the screen.

- 1 [Document Box] key > [▲] [▼] key > [Quick Copy] > [OK] key

NOTE

If the default screen of the box is set to a Custom Box, display the Job Box screen.

[Document Box] key > [Back] key > [▲] [▼] key > [Job Box] > [OK] key

- 2 Select the creator of the document, and select the [OK] key.

2 Print the document.

- 1 Select the document to print, and [Select] > [OK] key.

The file is selected. A checkmark will be placed on the right of the selected file.

Checkmarks will be placed on the right of the all files when [All Files] is selected.

When all files are checked, all checkmarked files are deselected.

Select the checkmarked file and select [Select] again to cancel the selection.

- 2 [▲] [▼] key > [Print] > [OK] key

- 3 Specify the number of copies to print as desired, and the [OK] key > [Yes].

Printing starts.

Deleting the Documents

You can delete the documents stored in the Quick Copy box. The procedure is as follows.

1 Display the screen.

- 1 [Document Box] key > [▲] [▼] key > [Quick Copy] > [OK] key



NOTE

If the default screen of the box is set to a Custom Box, display the Job Box screen.

[Document Box] key > [Back] key > [▲] [▼] key > [Job Box] > [OK] key

- 2 Select the creator of the document, and select the [OK] key.

2 Delete the document.

- 1 Select the document to delete, and [Select] > [OK] key.

The file is selected. A checkmark will be placed on the right of the selected file.

Checkmarks will be placed on the right of the all files when [All Files] is selected.

When all files are checked, all checkmarked files are deselected.

Select the checkmarked file and select [Select] again to cancel the selection.

- 2 [▲] [▼] key > [Delete] > [OK] key > [Yes]

The document is deleted.

Printing Document from Proof and Hold Box

The Proof and Hold feature produces only a single proof print of multiple-print job and holds printing of the remaining copies. Printing a multiple-print job in Proof and Hold using the printer driver allows only a single copy to be printed while maintaining the document data in the Job Box. To continue to print the remaining copies, use the operation panel. You can change the number of copies to print.

The following operations are possible:

- ➔ [Printing the Documents \(page 4-15\)](#)
- ➔ [Deleting the Documents \(page 4-16\)](#)

Printing the Documents

You can print the documents stored in the Proof and Hold box. The procedure is as follows.

1 Display the screen.

- 1 [Document Box] key > [▲] [▼] key > [Quick Copy] > [OK] key



NOTE

If the default screen of the box is set to a Custom Box, display the Job Box screen.

[Document Box] key > [Back] key > [▲] [▼] key > [Job Box] > [OK] key

- 2 Select the creator of the document, and select the [OK] key.

2 Print the document.

- 1 Select the document to print, and [Select] > [OK] key.

The file is selected. A checkmark will be placed on the right of the selected file.

Checkmarks will be placed on the right of the all files when [All Files] is selected.

When all files are checked, all checkmarked files are deselected.

Select the checkmarked file and select [Select] again to cancel the selection.

- 2 [▲] [▼] key > [Print] > [OK] key
- 3 Specify the number of copies to print as desired, and the [OK] key > [Yes].
Printing starts.

Deleting the Documents

You can delete the documents stored in the Proof and Hold box. The procedure is as follows.

1 Display the screen.

- 1 [Document Box] key > [▲] [▼] key > [Quick Copy] > [OK] key



NOTE

If the default screen of the box is set to a Custom Box, display the Job Box screen.

[Document Box] key > [Back] key > [▲] [▼] key > [Job Box] > [OK] key

- 2 Select the creator of the document, and select the [OK] key.

2 Delete the document.

- 1 Select the document to delete, and [Select] > [OK] key.

The file is selected. A checkmark will be placed on the right of the selected file.

Checkmarks will be placed on the right of the all files when [All Files] is selected.

When all files are checked, all checkmarked files are deselected.

Select the checkmarked file and select [Select] again to cancel the selection.

- 2 [▲] [▼] key > [Delete] > [OK] key > [Yes]

The document is deleted.

Job Box Setting

Configures settings for Job Box.

1 Display the screen.

[Document Box] key > [▲] [▼] key > [Job Box Setting] > [OK] key



NOTE

If the default screen of the box is set to a Custom Box, display the Job Box screen.

[Document Box] key > [Back] key > [▲] [▼] key > [Job Box] > [OK] key

2 Configure the settings.

The available settings are shown below.

Item	Description
Quick Copy Jobs	<p>To maintain free space on the box, you can set the maximum number of stored jobs.</p> <p>Value: number between 0 and 300</p> <p> NOTE</p> <p>When 0 is set, Quick Copy cannot be used.</p>
JobRet. Deletion	<p>This setting specifies that documents, such as Private Printing, Quick Copying, or Proof and Hold Printing, saved temporarily in the job box are automatically deleted after they have been saved for a set time.</p> <p>Value: Off, 1 hour, 4 hours, 1 day, 1 week</p> <p> NOTE</p> <p>This function is valid for documents saved after the function is set. Regardless of this function setting, temporary documents are deleted when the main power switch is turned off.</p>
Storage Media	<p>Select which storage media to use.</p> <p>Value: SSD, SD Card</p> <p> NOTE</p> <p>This setting is not displayed if the optional SSD or SD card is not installed.</p>

Status Monitor

The Status Monitor monitors the printer status and provides an ongoing reporting function.

NOTE

When you activate Status Monitor, check the status below.

- Printing System Driver is installed.
- Either **[Enhanced WSD]** or **[EnhancedWSD(SSL)]** are set to **[On]** in "TCP/IP Settings".

➔ [TCP/IP Settings \(page 8-15\)](#)

Accessing the Status Monitor

The Status Monitor also starts up when printing is started.

Exiting the Status Monitor

Use either of the methods listed below to exit the Status Monitor.

- Exit manually:
Click the settings icon and select Exit in the menu to exit the Status Monitor.
- Exit automatically:
The Status Monitor automatically shuts down after 7 minutes if it is not being used.

Status Monitor Display

The display of the Status Monitor is as follows.

Quick View State

The status of the printer is displayed using icons. Detailed information is displayed when the Expand button is clicked.

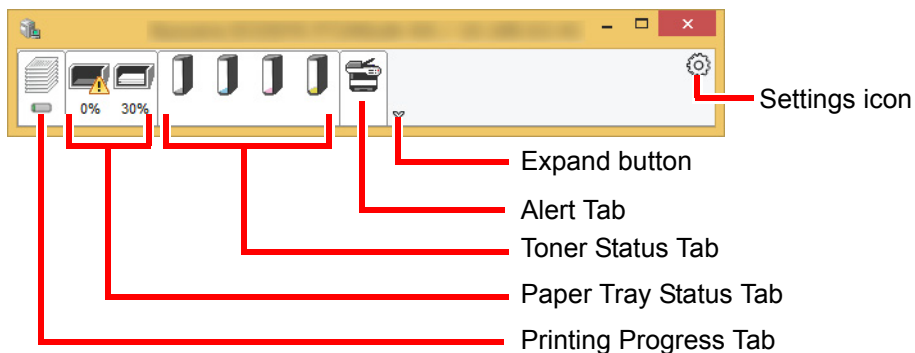

Detailed information is displayed by clicking on each icon tab.

Printing Progress Tab

The status of the print jobs is displayed.

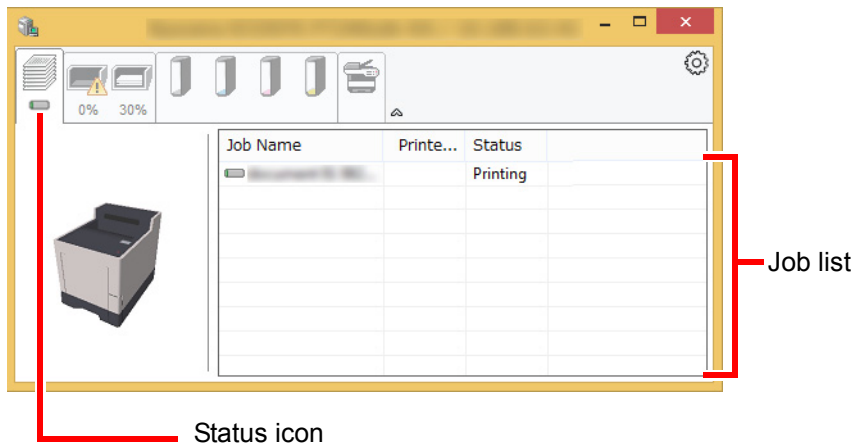

Select a job on the job list and it can be canceled using the menu displayed with a right-click.

Paper Tray Status Tab

Information is displayed about the paper in the printer and about the amount of paper remaining.

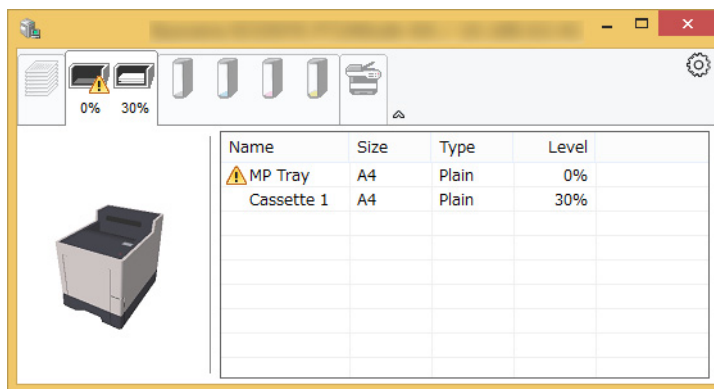

Toner Status Tab

The amount of toner remaining is displayed.

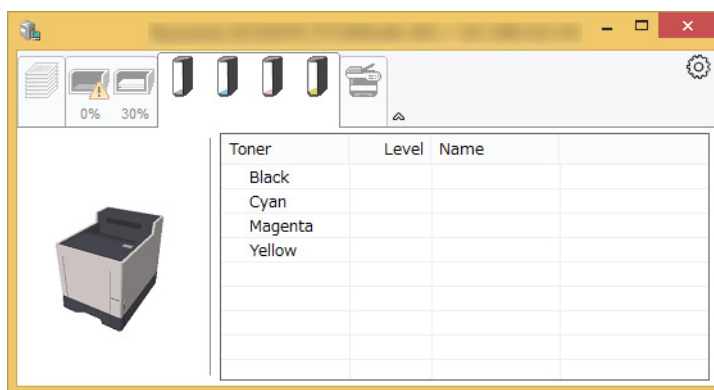

Alert Tab

If an error occurs, a notice is displayed using a 3D image and a message.

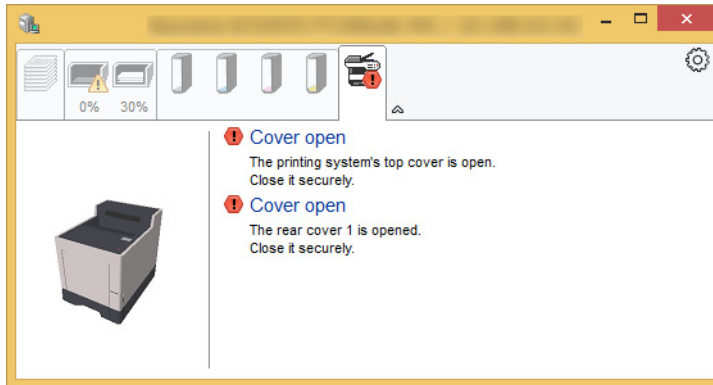

Status Monitor Context Menu

The following menu is displayed when the settings icon is clicked.

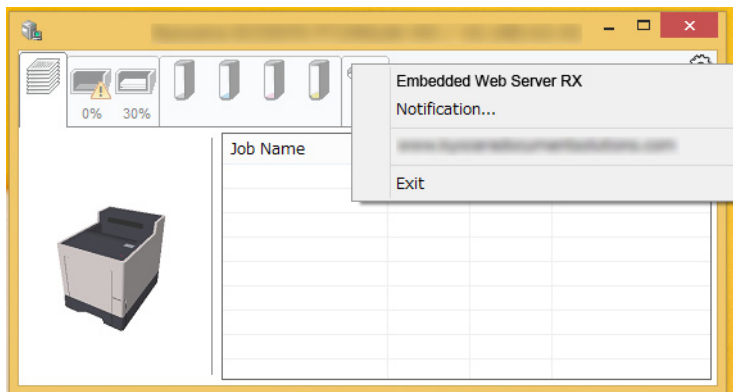

- **Embedded Web Server RX**
If the printer is connected to a TCP/IP network and has its own IP address, use a web browser to access the Embedded Web Server RX to modify or confirm the network settings. This menu is not displayed when using USB connection.
➔ **Embedded Web Server RX User Guide**
- **Notification...**
This sets the display of the Status Monitor.
➔ [Status Monitor Notification Settings \(page 4-21\)](#)
- **Exit**
Exits the Status Monitor.

Status Monitor Notification Settings

The Status Monitor settings and event list details are displayed.

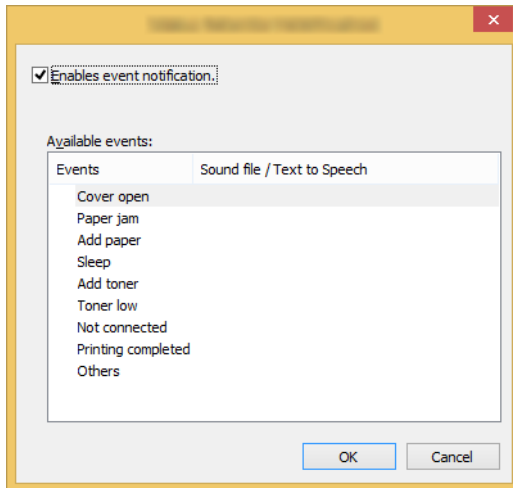

Select whether notification is performed when an error in the event list occurs.

1 Select Enable event notification.

If this setting is set to Off, then the Status Monitor will not start up even when printing is executed.

2 Select an event to use with the text to speech function in Available events.

3 Click Sound file / Text to Speech column.

Click the browse (...) button to notify the event by sound file.

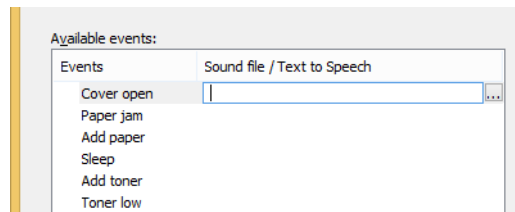

NOTE

The available file format is WAV.

When customizing the message texts to read on the screen aloud, enter the texts in the text box.

5 Operation on the Machine

This chapter explains the following topics:

Canceling Jobs	5-2
What is Document Box?	5-3
Using a Custom Box	5-5
Creating a New Custom Box	5-5
Editing and Deleting Custom Box	5-7
Storing Documents	5-7
Printing Documents	5-8
Editing Documents	5-9
Deleting Documents	5-10
Printing Documents Stored in Removable USB Memory	5-11
Removing USB Memory	5-13

Canceling Jobs

You can also cancel jobs by selecting the **[Cancel]** key.

1 While the printer displays "Processing.", select [Cancel] key.

The "Job Cancel List" appears, showing the list of current print jobs.

2 Cancel a job.

1 Select the job to cancel, and the **[OK]** key.

2 Select **[Yes]**.

The job is canceled.



NOTE

"Canceling..." appears on the message display and printing stops after the current page is printed.

What is Document Box?

Document Box contains four types of component boxes which provide the following functions.

The following types of document boxes are available.

Custom Box ([page 5-5](#))

Custom Box is a component box which you can create within the Document Box and store data for later retrieval. You can create or delete a Custom Box, and manipulate data in various ways as described below:

- ➔ [Creating a New Custom Box \(page 5-5\)](#)
- [Storing Documents \(page 5-7\)](#)
- [Printing Documents \(page 5-8\)](#)
- [Editing Documents \(page 5-9\)](#)
- [Deleting Documents \(page 5-10\)](#)



NOTE

To use Custom Box, an optional SSD must be installed in the machine.

Job Box

This is a box to save jobs executed from a PC.



NOTE

- You can set up the machine so that temporary documents in job boxes are automatically deleted.
- ➔ [JobRet. Deletion \(page 4-17\)](#)
- For details on operating the Job Box, refer to the following:
 - ➔ [Printing Data Saved on the Printer \(page 4-8\)](#)

Private Print/Stored Job Box ([page 4-9](#), [page 4-11](#))

In Private Printing, you can specify that a job is not to be printed until you operate the machine. When sending the job from the application software, specify a 4-digit access code in the printer driver. The job is released for printing by entering the access code on the operation panel, ensuring confidentiality of the print job. The data will be deleted upon completion of the print job or after the power switch is turned off.

In Stored Job, the print data sent from the application is saved to the machine. You can set up an access code as necessary. If you set up an access code, enter the access code when printing. Print data will be stored in the Job Box after printing. This will allow printing of the same print data repeatedly.

Quick Copy/Proof and Hold Box ([page 4-13](#), [page 4-15](#))

Quick Copy feature facilitates additional prints of a document already printed. Activating Quick Copy and printing a document using the printer driver allow the print data to be stored in the Job Box. When additional copies are required, you can reprint the required number of copies from the operation panel. By default, up to 32 documents can be stored. When power is turned off, all stored jobs will be deleted.



NOTE

When you attempt to store documents in excess of the above maximum, the oldest document data will be overwritten by the latest document data.

The Proof and Hold feature produces only a single proof print of multiple-print job and holds printing of the remaining copies. Printing a multiple-print job in Proof and Hold using the printer driver allows only a single copy to be printed while maintaining the document data in the Job Box. To continue to print the remaining copies, use the operation panel. You can change the number of copies to print.

Removable Memory Box ([page 5-11](#))

A USB memory stick can be connected to the USB memory slot on the machine to print a saved file. You can print data directly from the USB memory without a PC.

Using a Custom Box

Custom Box is a component box which you can create within the Document Box and store data for later retrieval. You can create or delete a Custom Box, and manipulate data in various ways as described below:

➔ [Creating a New Custom Box \(page 5-5\)](#)

[Storing Documents \(page 5-7\)](#)

[Printing Documents \(page 5-8\)](#)

[Editing Documents \(page 5-9\)](#)

[Deleting Documents \(page 5-10\)](#)

NOTE

The operation on Custom Box you perform from operation panel can also be made using Embedded Web Server RX.

➔ [Embedded Web Server RX User Guide](#)

Creating a New Custom Box

NOTE

- To use Custom Box, an optional SSD must be installed in the machine.
- If user login administration is enabled, you can only change the settings by logging in with administrator privileges. The factory default login user name and login password are set as shown below.

	P-C3562DN	P-C4072DN
Login User Name:	3500	4000
Login Password:	3500	4000

- If user login administration is enabled, log in with administrator privileges to perform the following operations. They cannot be performed with user privileges.
 - Creating a box
 - Deleting a box of which owner is another user.

1 Display the screen.

Select the **[Document Box]** key.

NOTE

If the default screen of the box is set to a Job Box, display the Custom Box screen.

[Document Box] key > **[Back]** key > **[▲]** **[▼]** key > **[Custom Box]** > **[OK]** key

2 Create a custom box.

1 Select **[Add]**.

2 Enter the box name and select the **[OK]** key.

NOTE

Up to 32 characters can be entered.

For details on entering characters, refer to the following:

➔ [Character Entry Method \(page 11-10\)](#)

- 3 Enter a box number and select the [OK] key.

 **NOTE**

You can set any value between 0001 and 1000.
Use the [▲] or [▼] key or the numeric keys to enter a number.

If you specify a box number that is already in use, an error message appears when you select the [OK] key and the number cannot be registered. If you enter 0000, the smallest number available will be automatically assigned.

- 4 To complete the box registration, select [▲] [▼] key > [Exit] > [OK] key.
The Custom Box is created.
To register further Box information, select [▲] [▼] key > [Detail] > [OK] key.
Proceed to next step.

3 Enter the box information.

Select [Edit] or [Change] on each item and enter the information then select the [OK] key. Select the [▶] key to view the next screen. Select the [◀] key to return to the previous screen. The table below lists the items to be set.

Item	Description
Box Name	Enter a box name consisting of up to 32 characters. ➔ Character Entry Method (page 11-10)
Owner *1 *2	Set the owner of the box. Select the owner from the user list that appears.
Permission *1	Select whether to share the box.
Box Password	User access to the box can be restricted by specifying a password to protect the box. Entering a password is not mandatory. Enter a password of up to 16 characters and select the [OK] key. Reenter the same password for confirmation and select the [OK] key. This can be set if [Shared] is selected in "Permission".
Box Number	Enter the box number by using the numeric keys or using the [▲] or [▼] key. The box number can be from 0001 to 1000. A Custom Box should have a unique number. If you enter 0000, the smallest number available will be automatically assigned.
Usage Restrict.	The usage for a box can be restricted. To enable a capacity restriction enter a value for the storage capacity of the Custom Box in megabytes by using the numeric keys or using the [▲] or [▼] key. You can enter a limit between 1 and 30,000 (MB).
Auto File Del.	Automatically deletes stored documents after a set period of time. To enable automatic deletion, select [▲] [▼] key > [Off/On] > [OK] key > [▲] [▼] key > [On] > [OK] key. To set the period that the document will be stored, select [▲] [▼] key > [Period] > [OK] key. Use the numeric keys or use the [▲] or [▼] key to enter the number of days for which documents are stored. You can enter any number between 1 and 31 (day(s)). To disable automatic file deletion, select [▲] [▼] key > [Off/On] > [OK] key > [▲] [▼] key > [Off] > [OK] key.
OverwriteSetting	Specifies whether or not old stored documents are overwritten when new documents are stored. To overwrite old documents, select [▲] [▼] key > [Permit] > [OK] key. To retain old documents, select [▲] [▼] key > [Prohibit] > [OK] key.
Del. afterPrint	Automatically delete a document from the box once printing is complete. To delete the document, select [▲] [▼] key > [On] > [OK] key. To retain the document, select [▲] [▼] key > [Off] > [OK] key.

*1 Displayed when the user login administration is enabled.

*2 Displayed when the user has logged in as administrator.

Editing and Deleting Custom Box

1 Display the screen.

Select the [Document Box] key.



NOTE

If the default screen of the box is set to a Job Box, display the Custom Box screen.

[Document Box] key > [Back] key > [▲] [▼] key > [Custom Box] > [OK] key

2 Edit the custom box.

To edit

- 1 Select the box you want edit and select the [OK] key.



NOTE

- When you have logged in as a user, you can only edit a box whose owner is set to that user.
- When you have logged in as administrator, you can edit all boxes.
- If a custom box is protected by a password, enter the correct password.

- 2 [Menu] > [▲] [▼] key > [Box Detail/Edit] > [OK] key

- 3 Change the box information.

➔ [Creating a New Custom Box \(page 5-5\)](#)

To delete

- 1 Select the box you want delete and [OK] key.



NOTE

- When you have logged in as a user, you can only delete a box whose owner is set to that user.
- When you have logged in as administrator, you can delete all boxes.

- 2 [Menu] > [▲] [▼] key > [Delete] > [OK] key > [Yes]



NOTE

If a custom box is protected by a password, enter the correct password.

Storing Documents

Custom box stores the print data which is sent from a PC. For the operation of the printing from the PC, refer to the following:

➔ **Printing System Driver User Guide**

Printing Documents

The procedure for printing documents in a custom box is explained below.

1 Display the screen.

- 1 Select the **[Document Box]** key.

NOTE

If the default screen of the box is set to a Job Box, display the Custom Box screen.

[Document Box] key > **[Back]** key > **[▲]** **[▼]** key > **[Custom Box]** > **[OK]** key

- 2 Select the box containing the document you want to print, and select the **[OK]** key.

NOTE

- If a custom box is protected by a password, enter the correct password.
- Select **[Select]** to perform the following operations.
 - **[Sort]**: Sort the boxes.
 - **[Search(No.)]**: Search using the box number.

2 Print the document.

- 1 Select the document you want to print, and select **[Select]**.

A checkmark will be placed on the right of the selected file.

Checkmarks will be placed on the right of the all files when **[All Files]** is selected.

When all files in the Custom Box are checked, all checkmarked files are deselected.

Select the checkmarked file and select **[Select]** again to cancel the selection.

NOTE

Select **[Menu]** to perform the following operations.

- **[Search(Name)]**: Search using a file name.
- **[Box Detail/Edit]**: Show and edit box details.
 - ➔ [To edit \(page 5-7\)](#)
- **[File Detail]**: Display the details for the selected file.
- **[Delete]**: Delete the document.
 - ➔ [To delete \(page 5-7\)](#)

- 2 Select the **[OK]** key.

To use the settings used at the time of printing (when the document was saved), select **[▲]** **[▼]** key > **[Print]** > **[OK]** key.

To change the print settings, select **[▲]** **[▼]** key > **[Print(ChangeSet)]** > **[OK]** key.

If **[Print]** is selected, change the number of copies to print as necessary.

If **[Print (ChangeSet)]** is selected, change the print settings. For the features that can be selected, refer to the following:

➔ [Custom Box \(Printing\) \(page 6-2\)](#)

Printing of the selected document begins.

Editing Documents

This function allows you to move documents stored in custom boxes into other boxes. The procedure for moving documents is explained below.

1 Display the screen.

- 1 Select the **[Document Box]** key.

 **NOTE**

If the default screen of the box is set to a Job Box, display the Custom Box screen.

[Document Box] key > **[Back]** key > **[▲]** **[▼]** key > **[Custom Box]** > **[OK]** key

- 2 Select the box containing the document you want to move, and select the **[OK]** key.

 **NOTE**

- If a custom box is protected by a password, enter the correct password.
- Select **[Menu]** to perform the following operations.
 - **[Sort]**: Sort the boxes.
 - **[Search(No.)]**: Search using the box number.

2 Move the documents.

- 1 Select the document you want to move, and select **[Select]**.

A checkmark will be placed on the right of the selected file.

Checkmarks will be placed on the right of the all files when **[All Files]** is selected.

When all files in the Custom Box are checked, all checkmarked files are deselected.

Select the checkmarked file and select **[Select]** again to cancel the selection.

 **NOTE**

Select **[Menu]** to perform the following operations.

- **[Search(Name)]**: Search using a file name.
- **[Box Detail/Edit]**: Show and edit box details.
 - ➔ [To edit \(page 5-7\)](#)
- **[File Detail]**: Display the details for the selected file.
- **[Delete]**: Delete the document.
 - ➔ [To delete \(page 5-7\)](#)

- 2 **[OK]** key > **[▲]** **[▼]** key > **[Move]** > **[OK]** key

- 3 Select the destination box, and the **[OK]** key.

The selected document is moved.

 **NOTE**

If the box to which the document is to be moved is protected by a password, enter the correct password.

Deleting Documents

The procedure for deleting documents in a custom box is explained below.

1 Display the screen.

- 1 Select the **[Document Box]** key.



NOTE

If the default screen of the box is set to a Job Box, display the Custom Box screen.

[Document Box] key > **[Back]** key > **[▲]** **[▼]** key > **[Custom Box]** > **[OK]** key

- 2 Select the box containing the document you want to delete, and select the **[OK]** key.



NOTE

- If a custom box is protected by a password, enter the correct password.
- Select **[Menu]** to perform the following operations.
 - **[Sort]**: Sort the boxes.
 - **[Search(No.)]**: Search using the box number.

2 Delete the document.

- 1 Select the document you want to delete, and select **[Select]**.

A checkmark will be placed on the right of the selected file.

Checkmarks will be placed on the right of the all files when **[All Files]** is selected.

When all files in the Custom Box are checked, all checkmarked files are deselected.

Select the checkmarked file and select **[Select]** again to cancel the selection.



NOTE

Select **[Menu]** to perform the following operations.

- **[Search(Name)]**: Search using a file name.
- **[Box Detail/Edit]**: Show and edit box details.
 - ➔ [To edit \(page 5-7\)](#)
- **[File Detail]**: Display the details for the selected file.
- **[Delete]**: Delete the document.
 - ➔ [To delete \(page 5-7\)](#)

- 2 **[OK]** key > **[▲]** **[▼]** key > **[Delete]** > **[OK]** key > **[Yes]**

Printing Documents Stored in Removable USB Memory

Plugging USB memory directly into the machine enables you to quickly and easily print the files stored in the USB memory without having to use a computer.

The following file types can be printed:

PDF file (Version 1.7 or older)

TIFF file (TIFF V6/TTN2 format)

JPEG file

XPS file

OpenXPS file

Encrypted PDF file

- PDF files you wish to print should have an extension (.pdf).
- Files to be printed should be saved no further down than the top 3 folder levels, including the root folder.
- Plug the USB memory directly into the USB Memory Slot.

1 Plug the USB memory.

Plug the USB memory into the USB Memory Slot.

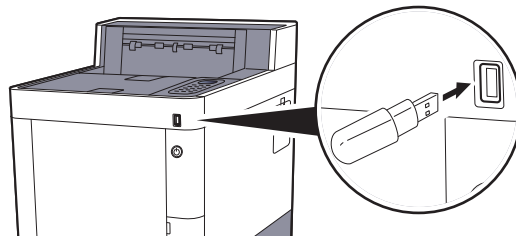

NOTE

If the USB memory screen does not appear, display the screen for USB memory.

[Menu] key > [▲] [▼] key > [USB Memory] > [OK] key

2 Print the document.

1 [▲][▼] key > [Print File] > [OK] key

2 Select the folder containing the file to be printed, and select the [OK] key.

The machine will display documents in the top 3 folder levels, including the root folder.



NOTE

- 1,000 documents can be displayed.
- To return to a higher level folder, select the [Back] key.

- 3 Select the document, and select the **[OK]** key.



NOTE

Select **[Detail]** to show the details of the selected folder or document.

- 4 Change the number of copies, duplex printing, etc. as desired.

For the features that can be selected, refer to the following:

➔ [Removable Memory \(Printing Documents\) \(page 6-3\)](#)

- 5 Select the **[OK]** key.

Printing of the selected file begins.

Removing USB Memory

Follow the steps below to remove the USB memory.

 **IMPORTANT**

Be sure to follow the proper procedure to avoid damaging the data or USB memory.

1 Display the screen.

[Menu] key > [▲] [▼] key > [USB Memory] > [OK] key

2 Select [Remove Memory].

[▲] [▼] key > [Remove Memory] > [OK] key

3 Remove the USB memory.

6 Using Various Functions

This chapter explains the following topics:

Functions Available on the Machine	6-2
Custom Box (Printing)	6-2
Removable Memory (Printing Documents)	6-3
Functions	6-4
EcoPrint	6-4
Duplex	6-4
Job Finish Notice	6-4
File Name Entry	6-5
Quiet Mode	6-5
Del. after Print (Delete after Printed)	6-5
Encrypted PDF	6-5
TIFF/JPEG Size	6-6
XPS FitTo Page	6-6

Functions Available on the Machine

Custom Box (Printing)

For details on each function, see the table below.

Functions	Description	Reference page
Quiet Mode	Lower print speed for quiet processing.	page 6-5
Duplex	Print a document on both sides of the paper.	page 6-4
EcoPrint	EcoPrint saves toner when printing.	page 6-4
File Name Entry	Adds a file name.	page 6-5
Job Finish Notice	Sends E-mail notice when a job is complete.	page 6-4
Del. after Print	Automatically deletes a document from the box once printing is complete.	page 6-5

Removable Memory (Printing Documents)

For details on each function, see the table below.

Function key	Description	Reference page
Quiet Mode	Lower print speed for quiet processing.	page 6-5
Duplex	Print a document on both sides of the paper.	page 6-4
EcoPrint	EcoPrint saves toner when printing.	page 6-4
File Name Entry	Adds a file name.	page 6-5
JobFinish Notice	Sends E-mail notice when a job is complete.	page 6-4
Encrypted PDF	Enter the preassigned password to print the PDF data.	page 6-5
TIFF/JPEG Size	Select the image size when printing JPEG or TIFF files.	page 6-6
XPS FitTo Page	Reduces or enlarges the image size to fit to the selected paper size when printing XPS file.	page 6-6

Functions

EcoPrint

EcoPrint saves toner when printing.

Use this function for test prints or any other occasion when high quality print is not required.

(Value: [Off] / [On])

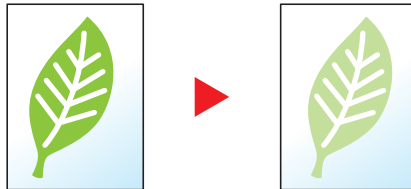

Duplex

Print a document on both sides of the paper.

The following modes are available.

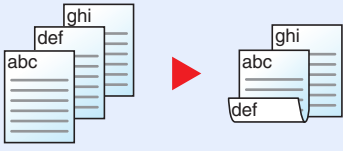
Item	Description
Off	Disables the function.
Bind Long Edge 	Prints the reverse side of a document in the same orientation as the front side.
Bind Short Edge 	Prints the reverse side of a document rotated 180° with respect to the front side. When the printed pages are bound at the top, the reverse side will be in the same orientation as the front side when the pages are turned.

Job Finish Notice

Sends E-mail notice when a job is complete.

Users can be notified of the completion of a job while working at a remote desk, saving the time spent waiting beside the machine to finish.



NOTE

PC should be configured in advance so that E-mail can be used.

➔ [Embedded Web Server RX \(page 2-38\)](#)

E-mail can be sent to a single destination.

Item	Description
Off	Disables the function.
Job Finished Only	Enter E-mail address directly. Enter the address (up to 128 characters) and select the [OK] key.
Job Finished + Job Interrupted	

File Name Entry

Adds a file name.

Additional information such as job number and date and time can also be set. You can check a job history or job status using the file name, date and time, or job number specified here.

To add date and time, select **[Date]** and the **[OK]** key. To add job number, select **[Job No.]** and the **[OK]** key. To add both, select **[Job No. + Date]** or **[Date + Job No.]** and the **[OK]** key.

Quiet Mode

Lower print speed for quiet processing.

Select this mode when the running noise is uncomfortable.

It is possible to set the use of Quiet Mode for each function.

(Value: **[Off]** / **[On]**)



NOTE

- The processing speed will be slower than normal when in Quiet Mode.
- This cannot be used when **[Prohibit]** is set for "Each Job".

➔ [Each Job \(page 8-34\)](#)

Del. after Print (Delete after Printed)

Automatically deletes a document from the box once printing is complete.

(Value: **[Off]** / **[On]**)

Encrypted PDF

Enter the preassigned password to print the PDF data.

Enter the Password, and select **[OK]**.



NOTE

For details on entering the password, refer to the following:

➔ [Character Entry Method \(page 11-10\)](#)

TIFF/JPEG Size

Select the image size when printing JPEG or TIFF files.

(Value: [Paper Size] / [Image Resolution] / [Print Resolution])

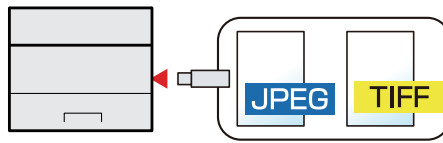

Item	Description
Paper Size	Fits the image size to the selected paper size.
Image Resolution	Prints at resolution of the actual image.
Print Resolution	Fits the image size to the print resolution.

XPS FitTo Page

Reduces or enlarges the image size to fit to the selected paper size when printing XPS file.

(Value: [Off] / [On])

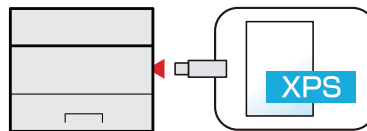

7 Status/Job Cancel

This chapter explains the following topics:

Checking Job Status	7-2
Checking Job History	7-3
Sending the Log History	7-4
Device/Communication	7-5
Checking the Remaining Amount of Toner and Paper (Paper/Supplies)	7-6

Checking Job Status

Check the status of jobs being processed or waiting to be printed.

Displaying Status Screens

1 Display the screen.

While the machine is printing or awaiting printing, select **[Status]** > **[▲]** **[▼]** key > **[Job Status]** > **[OK]** key.

2 Select the job you want to check.

Select the job you want to check, and **[OK]** key or **[Detail]**.



NOTE

You can show the job statuses of all users, or only the statuses of your own jobs.

➔ [Disp. Status/Log \(page 8-30\)](#)

This setting can also be changed from Embedded Web Server RX.

➔ [Embedded Web Server RX User Guide](#)

3 Check the status.

Select the **[▶]** key to view the next screen. Select the **[◀]** key to return to the previous screen.

Item	Description
Job Name	When the job name in Job Name is displayed in a short form, select [Detail] to see the complete job name. Select the [OK] key to return to the previous screen.
Status	Status of job [Processing] : The status before starting to print. [Pause] : Pausing print job or error [Canceling] : Canceling the job [Waiting] : Waiting Printing [----] : The job is finished.
Job Type	[Printer] : Printer job [Report] : Report/List [USB] : Data from removable memory [Box] : Job from Document Box
Accepted Time	Accepted Time of job
User Name	User Name for the executed job If user login administration is disabled, [----] appears.
Printed Pages	<ul style="list-style-type: none"> Number of pages printed Number of copies printed / Total number of copies to be printed
Color/B & W	Color mode [Full Color] [Black & White] [Mixed]

Checking Job History

Check the history of completed jobs.

NOTE

Job history is also available by Embedded Web Server RX or NETWORK PRINT MONITOR from the computer.

- ➔ [Embedded Web Server RX User Guide](#)
- ➔ [NETWORK PRINT MONITOR User Guide](#)

Displaying Job History Screen



1 Display the screen.

- 1 While the machine is printing or awaiting printing, select [**Status**].
- 2 [**▲**] [**▼**] key > [**Job Status**] > [**OK**] key

2 Select the job you want to check.

Select the job you want to check, and the [**OK**] key or [**Detail**].

A job result icon is displayed on the extreme right of each job.

- **OK**: The job has been completed.
- : An error has occurred.
- : The job has been canceled.

NOTE

You can show the job log of all users, or only your own job log.

- ➔ [Disp. Status/Log \(page 8-30\)](#)

This setting can also be changed from Embedded Web Server RX.

- ➔ [Embedded Web Server RX User Guide](#)

3 Check the job history.

Select the [**▶**] key to view the next screen. Select the [**◀**] key to return to the previous screen.

Item	Description
Job Name	When the job name in Job Name is displayed in a short form, select [Detail] to see the complete job name. Select the [OK] key to return to the previous screen.
Result	Result of job [OK]: The job has been completed. [Error]: An error has occurred. [Cancel]: The job has been canceled.
Job Type	[Printer]: Printer job [Report]: Report/List [USB]: Data from removable memory [Box]: Job from Document Box
Accepted Time	Accepted time of job
User Name	User Name for the executed job If user login administration is disabled, [----] appears.
Printed Pages	<ul style="list-style-type: none"> • Number of pages printed • Number of copies printed / Total number of copies to be printed
Color/B & W	Color mode [Color/B & W] [Full color] [Black & White] [Mixed]



NOTE

If the login user name entry screen appears during operations, log in by referring to the following:

➔ [Login \(page 2-13\)](#)

The factory default login user name and login password are set as shown below.

	P-C3562DN	P-C4072DN
Login User Name:	3500	4000
Login Password:	3500	4000

Sending the Log History

You can send the log history by E-mail. You can either send it manually as needed or have it sent automatically whenever a set number of jobs is reached.

➔ [Send History \(page 8-6\)](#)

Device/Communication

Configure the devices/lines installed or connected to this machine or check their status.

1 Display the screen.

Select **[Status]**, while the machine is printing or awaiting printing.

2 Check the status.

Select the items you want to check. Then, select the **[OK]** key to show the status of the selected device.

The items you can check are described below.

"Keyboard"

The status of the optional USB Keyboard and Bluetooth Keyboard are displayed.

"Network"

The network connection status appears.

"Wi-Fi"

- This function is displayed when the wireless network function is available on the machine.
- The Wi-Fi connection status and network name (SSID) of the machine appear.

"Wi-Fi Direct"

This function is displayed when the wireless network function is available on the machine.

- Select **[▲] [▼]** key > **[PushButton Setup]** > **[OK]** key, and execute the push button of the device you want to connect to start the connection to the machine.
- Select **[▲] [▼]** key > **[Detail Info]** > **[OK]** key, information on the device that is connected by Wi-Fi Direct appears.
- Select **[▲] [▼]** key > **[ConnectionStatus]** > **[OK]** key > **[▲] [▼]** key > **[ConnectedDevices]** > **[OK]** key to display the list of connected devices.
- Select **[▲] [▼]** key > **[ConnectionStatus]** > **[OK]** key > **[▲] [▼]** key > **[DisconnectAll]** > **[OK]** key to disconnect all devices.

"Option Network"

The connection status of the optional Network Interface Kit or Wireless Network Interface Kit is displayed.

Checking the Remaining Amount of Toner and Paper (Paper/Supplies)

Check the remaining amount of toner, and paper on the message display.

1 Display the screen.

To check the toner status, select [**Toner**] while the machine is awaiting printing.

If you select [**Paper**], you will return to the paper status screen.

2 Check the status.

The items you can check are described below.

"Toner Status"

The amount of toner remaining is shown in levels.

"Paper Status"

You can check the paper size and amount of paper remaining in the paper source. The amount of paper remaining is shown in levels.

8 Setup and Registration (System Menu)

This chapter explains the following topics:

System Menu	8-2
Menu Settings	8-3
Report	8-5
Paper Settings	8-7
Print Settings	8-10
Network	8-12
Optional Network	8-22
Device Common	8-25
Security	8-31
User/Job Account	8-33
Adjust/Maint.	8-34
Op Functions	8-34
Software	8-34

System Menu

Configure settings related to overall machine operation.

Select the **[Menu]** key to show the settings on the message display. Then, select from the settings displayed.

➔ [Operation Method \(page 2-11\)](#)



NOTE

- In order to change settings that require administrator privileges, you must log in with administrator privileges. The factory default login user name and login password are set as shown below.

	P-C3562DN	P-C4072DN
Login User Name:	3500	4000
Login Password:	3500	4000

- If function default settings have been changed, the **[Reset]** key can be selected in each function screen to immediately change the settings.

Refer to [Menu Settings](#) on the following page and configure as needed.

Menu Settings

This section explains the functions that can be configured in Menu. To configure the settings, select the item in System Menu and select the setting item. For details on each function, see the table below.

Item	Description	Reference Page
Report Print	Configure settings for printing reports and histories.	page 8-5
Job Log History		page 8-6
Counter	This counts the number of pages printed.	page 2-36
Paper Settings	Configure settings for paper.	page 8-7
Print Settings	Configure settings for printing.	page 8-10
Network	Configures network settings.	page 8-12
Primary Network	Specify the network to be used for the send function, the network authentication and connecting to external address book.	page 8-12
Optional Network	Configure settings for the optional Network Interface Kit or Wireless Network Interface Kit.	page 8-22
Language	Select the language displayed on the message display.	page 8-25
Def. Screen(Box)	Select the screen to be displayed when [Document Box] key is selected.	page 8-25
Date Setting	Configure settings related to the date and time.	page 8-25
Buzzer	Set options for buzzer sound during the machine operations.	page 8-26
RAM Disk Setting	A RAM disk can be created and its size can be set.	page 8-26
Format SSD	Format an optional SSD.	page 8-26
Format SD Card	Format an optional SD/SDHC memory card.	page 8-27
Display Bright.	Set the brightness of the message display.	page 8-27
Error Handling	Select whether to cancel or continue the job when error has occurred.	page 8-27
ColorToner Empty	Select whether printing is prohibited or the Print in Black and White setting is used for printing once the color toner runs out.	page 8-27
Timer Setting	Configure settings related to the time.	page 8-28
Disp. Status/Log	Set the display method of the Status/Log.	page 8-30
USB KeyboardType	Select the type of USB keyboard that you want to use.	page 8-30
Bluetooth Set.	Set the Bluetooth keyboard.	page 8-30
Low Toner Alert	Set the amount of remaining toner to notify the administrator when to order a toner when the toner is running low.	page 8-30
Security	The security functions can be set up to protect printer operation and the print data.	page 8-31
I/F Block Set.	This allows you to protect this machine by blocking the interface with external devices such as USB hosts or optional interfaces.	page 8-31
Security Level	The Security Level setting is primarily a menu option used by service personnel for maintenance work. There is no need for customers to use this menu.	—
Data Security	Configure settings for data stored in the optional SSD and machine's memory.	page 8-32

Item	Description	Reference Page
User/Job Account	Configures settings related to machine management. User Login: ➔ Overview of User Login Administration (page 9-2) Job Accounting: ➔ Overview of Job Accounting (page 9-14)	—
Adjust/Maint.	Adjust printing quality and conduct machine maintenance.	page 8-34
Restart	Restart the CPU without turning the power switch off. Use this to deal with any unstable operation by the machine. (Same as the computer restart.)	page 8-34
Op Functions	You can use the optional applications installed on this machine.	page 8-34
Software	Check the machine's system and engine software versions.	page 8-34

Report





Print reports to check the machine settings and status.

Default settings for printing the result reports can also be configured.

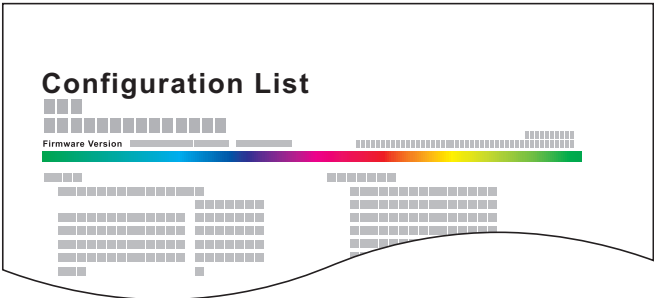
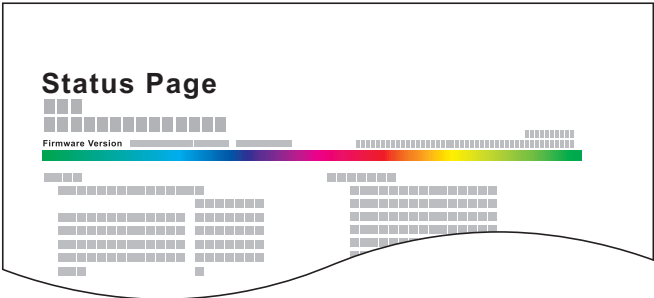
Report Print

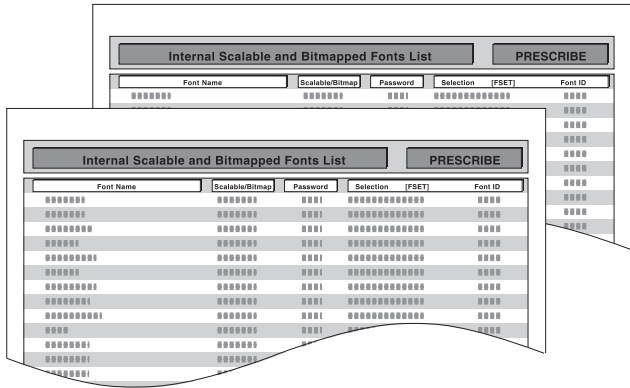
[Menu] key > [▲][▼] key > [Report] > [OK] key > [▲][▼] key > [Report Print] > [OK] key

Item	Description
<p>Menu Map</p>	<p>Prints Menu Map to check the settings of the machine.</p> 
<p>Config. List</p>	<p>Prints the list of settings of the system menu. The settings of this machine can be checked.</p> 
<p>Status Page</p>	<p>Prints the status page, allowing you to check the information including current settings, available memory space, and optional equipment installed.</p> 

Item	Description
Font List	<p>Prints the font list, allowing you to check the font samples installed in the machine.</p> 
RAM File List	<p>You can print a list of the files in the RAM disk.</p> <p> NOTE This setting is displayed when [RAM Disk Mode] is set to [On].</p>
SSD File List	<p>You can print a list of the files in the SSD.</p> <p> NOTE Displayed when the optional SSD is installed.</p>
SD Card FileList	<p>You can print a list of the files in the SD Card.</p> <p> NOTE Displayed when the optional SD Card is installed.</p>
DataSanitization	<p>You can print a Data Sanitization Report.</p>

Job Log History

[Menu] key > [▲] [▼] key > [Report] > [OK] key > [▲] [▼] key > [Job Log History] > [OK] key

Item	Description
Send History	<p>You can also send the log history to the specified destinations manually.</p>
Auto Sending	<p>This function automatically sends the log history to the specified destinations whenever a set number of jobs has been logged.</p> <p>Value Off/On: Off, On Jobs: Set the number of jobs at which the job history is automatically sent. The setting range is 1 to 100. This setting is displayed when [Off/On] is set to [On].</p>
Destination	<p>Set and check the destination to which log histories are sent.</p> <p>Value Confirmation: Check the destination to which log histories are sent. Address Entry: Set the destination to which log histories are sent. Only E-mail address can be set.</p>
Subject	<p>Set the subject automatically entered when sending log histories by E-mail.</p> <p>Value: Up to 60 characters</p>
Personal Info.	<p>Select whether to include personal information in the job log.</p> <p>Value: Include, Exclude</p>

Paper Settings

[Menu] key > [▲] [▼] key > [Paper Settings] > [OK] key

Configure settings for paper.

Item	Description
MP Tray Set.	Select the paper size and media type for the multi purpose tray. ➔ MP Tray Set. (page 8-7)
Cassette 1 (to 4) Set.	Select the paper size and media type for cassettes 1 to 4. ➔ Cassette 1 (to 4) Set. (page 8-8)
Media Type Set.	Select weight for each media type. For Custom 1-8, settings for duplex printing and media type name can be changed. ➔ Media Type Setting (page 8-9)
Reset Type Adj.	Resets the attribute settings of all media types set in "Media Type Set". ➔ Media Type Set. (page 8-7)
Paper Setup Msg	Set whether to display the confirmation screen for the paper setting when a new paper is set for each cassette.
MP Tray	Value: Off, On
Cassette 1 (to 4)	 NOTE [Cassette 2] to [Cassette 4] are displayed when the optional paper feeder is installed.

MP Tray Set.

[Menu] key > [▲] [▼] key > [Paper Settings] > [OK] key > [▲] [▼] key > [MP Tray Set.] > [OK] key

Select paper size and media type for the multi purpose tray.

Item	Description
Paper Size	Available options are as follows: Values: Envelope Monarch, Envelope #10, Envelope DL, Envelope C5, Executive, Letter, Legal, A4, B5, A5, A6, B6, Envelope #9, Envelope #6, ISO B5, Custom, Hagaki (Cardstock), Oufuku Hagaki (Return postcard), Oficio II, 216 × 340 mm, 16K, Statement, Folio, Youkei 2, Youkei 4
Media Type* ¹	Select the media type. Values: Plain (60 - 105 g/m ²), Transparency, Preprinted, Labels, Bond, Recycled, Vellum (60 - 105 g/m ²), Rough, Letterhead, Color, Prepunched, Envelope, Cardstock, Coated, Thick (106 - 220 g/m ²), High Quality, Custom 1 - 8

*1 To change to a media type other than "Plain".

➔ [Media Type Setting \(page 8-9\)](#)

Cassette 1 (to 4) Set.

[Menu] key > [▲] [▼] key > [Paper Settings] > [OK] key > [▲] [▼] key > [Cassette 1 (to 4) Set.] > [OK] key

Select paper size and media type for Cassettes 1 to 4.

Item	Description
Media Type ^{*1}	<p>Select the media type.</p> <p>Values</p> <p>Cassette 1: Plain (60 - 105 g/m²), Preprinted, Bond, Recycled, Vellum (60 - 105 g/m²), Rough, Letterhead, Color, Prepunched, Thick (106 - 163 g/m²), High Quality, CUSTOM 1 - 8</p> <p>Cassette 2 to 4: Plain (60 - 105 g/m²), Preprinted, Labels, Bond, Recycled, Vellum (60 - 105 g/m²), Rough, Letterhead, Color, Prepunched, Envelope, Coated, Thick (106 - 220 g/m²), High Quality, CUSTOM 1 - 8</p>
Other Paper Size	<p>Available options are as follows:</p> <p>Values</p> <p>Cassette 1: Executive, Letter, Legal, A4, B5, A5, A6, B6, ISO B5, Custom, Oficio II, 216 × 340 mm, 16K, Statement, Folio</p> <p>Cassette 2 to 4: Envelope Monarch, Envelope #10, Envelope DL, Envelope C5, Executive, Letter, Legal, A4, B5, A5, B6, Envelope #9, Envelope #6, ISO B5, Custom, Oficio II, 216 × 340 mm, 16K, Statement, Folio, Youkei 2, Youkei 4</p>
Custom PaperSize ^{*2}	<p>Register the custom paper size to be used in Cassettes 1 to 4.</p> <p>Values</p> <p>Cassette 1:</p> <p>Metric</p> <p>X: 105 to 216 mm (in 1 mm increments)</p> <p>Y: 148 to 356 mm (in 1 mm increments)</p> <p>Inch</p> <p>X: 4.13 to 8.50" (in 0.01" increments)</p> <p>Y: 5.83 to 14.02" (in 0.01" increments)</p> <p>Cassette 2 to 4:</p> <p>Metric</p> <p>X: 92 to 216 mm (in 1 mm increments)</p> <p>Y: 162 to 356 mm (in 1 mm increments)</p> <p>Inch</p> <p>X: 3.62 to 8.50" (in 0.01" increments)</p> <p>Y: 6.38 to 14.02" (in 0.01" increments)</p> <p>X=Length, Y=Width</p> <div data-bbox="890 1496 1082 1742" style="text-align: center;"> <p style="text-align: center;">Vertical</p> </div>

*1 To change to a media type other than "Plain".

➔ [Media Type Setting \(page 8-9\)](#)

When a paper weight that cannot be loaded in the cassette is set for a media type, that media type does not appear.

*2 Appears when [Custom] is selected in Other Paper Size.

Media Type Setting

The following media type and paper weight combinations are available.

Paper Weight	Weight (g/m ²)	Paper Weight	Weight (g/m ²)
Light	52 g/m ² to 59 g/m ²	Heavy 1* ¹	106 g/m ² to 135 g/m ²
Normal 1	60 g/m ² to 74 g/m ²	Heavy 2* ¹	136 g/m ² to 163 g/m ²
Normal 2	75 g/m ² to 90 g/m ²	Heavy 3* ¹	164 g/m ² to 220 g/m ²
Normal 3	91 g/m ² to 105 g/m ²	Extra Heavy* ¹	Transparencies

*1 The processing speed will be slower than normal.

Each media type's default weight is indicated.

Media Type	Default	Media Type	Default
Plain	Normal 2	Cardstock	Heavy 1
Transparency	Extra Heavy	Color	Normal 2
Rough	Normal 3	Prepunched	Normal 2
Vellum	Normal 1	Letterhead	Normal 2
Labels	Heavy 1	Envelope	Heavy 2
Recycled	Normal 2	Thick	Heavy 2
Preprinted	Normal 2	High Quality	Normal 2
Bond	Normal 3	Coated	Heavy 1
		Custom 1 - 8	Normal 2



For Custom 1-8, settings for duplex printing and media type name can be changed.



Item		Description
Duplex	Permit	Duplex printing allowed.
	Prohibit	Duplex printing not allowed.
Name Entry		Change names for Custom 1-8. Names should be not more than 16 characters. Selecting media type at multi purpose tray, the name after change will be displayed. ▶ Character Entry Method (page 11-10)

Print Settings

[Menu] key > [▲] [▼] key > [Print Settings] > [OK] key

Configure settings for printing.

Item	Description
Paper Source	<p>Select the default paper source from Cassette 1-4 and multi purpose tray. Values: MP Tray, Cassette 1 to 4</p> <p> NOTE [Cassette 2] to [Cassette 4] are shown when the optional paper feeder is installed.</p>
Auto Cass.Change	<p>Select the following actions when the paper runs out in the paper source while printing. Values: Off, On</p> <p> NOTE When selecting [Off], the machine displays "Add the following paper in cassette #." (# is a cassette number), or "Load paper in MP tray." and stops printing. Load the paper according to the paper source displayed to resume printing. To print from the other paper cassette, select [Alt.]. Select the desired paper source, and then select the [OK] key. When selecting [On], the machine continues printing automatically when the other cassette contains the same paper as the currently-used cassette.</p>
MP Tray Priority	<p>If paper is set in the MP Tray then it is possible for priority to be given to that MP tray in the paper feed. Values Off: The printer driver settings are followed. Auto Feed: If Auto is selected in the printer driver and there is paper in the MP tray then the paper feed will be from the MP tray. Always: If there is paper in the MP tray then the paper feed will be from the MP tray regardless of what is set in the printer driver.</p>
Paper Feed Mode	<p>While printing from the computer, select how to feed paper when the paper source and type are specified. Values Auto: Search the paper source that matches the selected paper size and type. Fixed: Print on paper loaded in the specified paper source.</p>
Duplex	<p>Select binding orientation for duplex mode. Values: Off, Bind Long Edge, Bind Short Edge</p>
Override A4/LTR	<p>Select whether to treat A4 size and Letter, which are similar in size, as the same size when printing. Values Off: A4 and Letter are not regarded as the same in size. On: A4 and Letter are regarded as the same in size. The machine will use whichever size is in the paper source.</p>
Emulation Set.	—
Emulation	<p>Select the emulation for operating this machine by commands oriented to other types of printers. Values: PCL6, KPDL, KPDL(Auto)</p>
KPDL Error Rpt.	<p>When you have selected [KPDL] or [KPDL (Auto)], set "KPDL Error Report". Values: Off, On</p>
Color Mode	<p>You can choose whether reports are printed in color or black and white. Values: Full Color, Black & White</p>

Item	Description
Print Quality	Set the Print Quality.
KIR	The machine is equipped with the smoothing function, which realizes an excellent printing of about 9600 dpi (600 dpi × 15 gradation) × 600 dpi. Value: Off, On
EcoPrint	EcoPrint conserves toner when printing. This is recommended for test copies where faded printing is not a problem. Values: Off, On
EcoPrint SaveLvl	Select the default EcoPrint SaveLvl. Values: 1 (Lower), 2, 3, 4, 5 (Higher)
Gloss Mode	Gloss Mode increases the effect of glossiness in printing. However, printing takes longer time. Values: Off, On  IMPORTANT Gloss Mode is not available when [Labels] or [Transparency] is selected as the paper type setting.  Cassette 1 (to 4) Set. (page 8-8) MP Tray Set. (page 8-7) Depending on the paper used, printing in gloss mode may cause curl in paper. To reduce curl, try using thicker paper.
Print Resolution	Set the resolution used for printing. Values: 600 dpi, 1200 dpi  NOTE Settings that are received from the printer driver have priority over the operation panel settings.
Page Setting	You can set print preferences such as the number of pages and print orientation.
Copies	Set the default number of copies, from 1 to 999. Value: 1 to 999 copies
Orientation	You can select portrait (upright) or landscape (sideways) page orientation. Value: Portrait, Landscape
LF Action	Set the line feed action when the machine receives the line feed code (character code 0AH). Values: LF Only, LF and CR, Ignore LF
CR Action	Set the character return action when the machine receives the character return code (character code 0DH). Values: CR Only, LF and CR, Ignore CR
Wide A4	Turn this to on to increase the maximum number of characters that can be printed in a line for an A4 page (78 characters at 10 pitch) and Letter size page (80 characters at 10 pitch). This setting is only effective in PCL 6 emulation. Value: Off, On
XPS FitTo Page	Set the default value for the XPS fit to page function. Value: Off, On
TIFF/JPEG Size	Select the image size (resolution) when printing JPEG or TIFF file. Value: Paper Size, Image Resolution, Print Resolution
User Name	Set whether the user name set in the printer driver is displayed. Value: Off, On

Item	Description
Job Name	Set whether the job name set in the printer driver is displayed. Value: Off, Job Name, Job No.+Job Name, Job Name+Job No.
Job Terminator	You can select the condition which regarded as a job termination if the print job could not be processed until the end due to your environment and the other reason. Value EOJ: Up to the detection of a command indicating the end of job data is regarded as one job. End of Session: The data included in a network session at network connection is regarded as one job. UEL: The UEL included in the termination of the job data is regarded as one job until it is detected.

Network

Configures network settings.

Host Name

[Menu] key > [▲] [▼] key > [Network] > [OK] key > [▲] [▼] key > [Host Name] > [OK] key

Item	Description
Host Name	Check the host name of the machine. Host name can be changed from Embedded Web Server RX. ➔ Changing Device Information (page 2-42)

Wi-Fi Direct Set

[Menu] key > [▲] [▼] key > [Network] > [OK] key > [▲] [▼] key > [Wi-Fi Direct Set] > [OK] key



Set Wi-Fi Direct.



NOTE

This function is displayed when the optional Wireless Network Interface Kit is installed.

Item	Description
Wi-Fi Direct	Select whether to use Wi-Fi Direct. Value: Off, On
Device Name	Specify the device name. NOTE <ul style="list-style-type: none"> Up to 32 characters can be entered. This function is displayed when [Wi-Fi Direct] is set to [On].
IP Address	Check the IP address of the machine. ➔ TCP/IP Settings (page 8-14) NOTE This function is displayed when [Wi-Fi Direct] is set to [On].

Item	Description
Auto Disconnect	Automatically disconnect devices connected through Wi-Fi Direct. Value: Off, On  NOTE This function is displayed when [Wi-Fi Direct] is set to [On] .
Disconnect Timer	If you select [ON] to Auto Disconnect, set the waiting time for automatic disconnection. Value: Day (00 to 99), Hour (00 to 23), Minute (00 to 59)  NOTE This function is displayed when [Auto Disconnect] is set to [On] .



Wi-Fi Settings





[Menu] key > **[▲]** **[▼]** key > **[Network]** > **[OK]** key > **[▲]** **[▼]** key > **[Wi-Fi Settings]** > **[OK]** key

Set Wi-Fi.

NOTE





This function is displayed when the optional Wireless Network Interface Kit is installed.

Item	Description
Wi-Fi	Select whether to use Wi-Fi. Value: Off, On
Setup	-
ConnectionStatus	Check the wireless LAN status.
Quick Setup	If the machine will connect to an access point that supports the automatic wireless network setup, connection settings can be configured by Quick Setup.  NOTE If you are connecting to an access point that has WEP enabled, select [WEP Key Index] and select the WEP key index.
AvailableNetwork	Displays access points to which the machine can connect.  NOTE <ul style="list-style-type: none"> • When [Reload] is selected, the list is reloaded. • If the access point's security setting uses WEP, select [Menu] and set [WEP Key Index].
WEP Key Index	Select the key index of the access point. Value: 0 to 3
Push Button	If the access point supports the push button method, wireless settings can be configured using the push button. This setting executes push button, and the connection is started by pressing the push button on the access point.  NOTE The push button method supports only the WPS.
PIN (Device)	Starts connection using the machine's PIN code. Enter the PIN code into the access point. The PIN code of the machine is automatically generated.

Item	Description																				
Custom Setup	The detailed settings for wireless LAN can be changed.																				
Network Name (SSID)	Set the SSID (Service Set Identifier) of the wireless LAN to which the machine connects.  NOTE Up to 32 characters can be entered.																				
Netwk Authentic.	Select network authentication type. Value: Open, WPA2/WPA-PSK, WPA2-PSK, WPA2/WPA-EAP, WPA2-EAP																				
Encryption	Select encryption method. The setting values vary depending on the Network Authentication setting. <table border="1"> <thead> <tr> <th>Network Authentication</th> <th colspan="2">Encryption</th> </tr> </thead> <tbody> <tr> <td rowspan="2">Open</td> <td>Disable</td> <td>—</td> </tr> <tr> <td>WEP</td> <td>WEP Key: Up to 26 characters WEP Key Index: 0 to 3</td> </tr> <tr> <td>WPA2/WPA-PSK</td> <td colspan="2">Data Encryption: AES, Auto Preshared Key: Up to 64 characters</td> </tr> <tr> <td>WPA2-PSK</td> <td colspan="2">Data Encryption: AES Preshared Key: Up to 64 characters</td> </tr> <tr> <td>WPA2/WPA-EAP</td> <td colspan="2">Data Encryption: AES, Auto</td> </tr> <tr> <td>WPA2-EAP</td> <td colspan="2">Data Encryption: AES</td> </tr> </tbody> </table>	Network Authentication	Encryption		Open	Disable	—	WEP	WEP Key: Up to 26 characters WEP Key Index: 0 to 3	WPA2/WPA-PSK	Data Encryption: AES, Auto Preshared Key: Up to 64 characters		WPA2-PSK	Data Encryption: AES Preshared Key: Up to 64 characters		WPA2/WPA-EAP	Data Encryption: AES, Auto		WPA2-EAP	Data Encryption: AES	
Network Authentication	Encryption																				
Open	Disable	—																			
	WEP	WEP Key: Up to 26 characters WEP Key Index: 0 to 3																			
WPA2/WPA-PSK	Data Encryption: AES, Auto Preshared Key: Up to 64 characters																				
WPA2-PSK	Data Encryption: AES Preshared Key: Up to 64 characters																				
WPA2/WPA-EAP	Data Encryption: AES, Auto																				
WPA2-EAP	Data Encryption: AES																				
TCP/IP Settings	-																				
TCP/IP	Select whether to use TCP/IP Protocol. Value: Off, On																				
IPv4 Setting	Set up TCP/IP (IPv4) to connect to the network. This setting is available when [TCP/IP] is set to [On].																				
DHCP	Select whether to use the DHCP (IPv4) server. Value: Off, On																				
Auto-IP	Select whether to use Auto-IP. Value: Off, On																				
IP Address	Set the IP address. Value: ###.###.###.###  NOTE When DHCP is set to [On], this item is displayed only and cannot be entered.																				
Subnet Mask	Set the IP subnet mask. Value: ###.###.###.###  NOTE When DHCP is set to [On], this item is displayed only and cannot be entered.																				
Default Gateway	Set the IP gateway address. Value: ###.###.###.###  NOTE When DHCP is set to [On], this item is displayed only and cannot be entered.																				

**IMPORTANT**

After changing the setting, restart the network or turn the machine OFF and then ON.

Item	Description
IPv6 Setting	Set up TCP/IP (IPv6) to connect to the network. This setting is available when [TCP/IP] is [On].
IPv6 Setting	Select whether to use IPv6. Value: Off, On  NOTE Selecting [On] displays IP address in [Link Local] after restarting the network.
Manual Settings	Manually specify the IP address, prefix length, and gateway address of TCP/IP (IPv6). Value IP Address: 128-bits address is expressed in eight groups consisting of four-digit hexadecimal digits. The groups are separated by colon (:). Prefix Length: 0 to 128 Default Gateway: 128-bits address is expressed in eight groups consisting of four-digit hexadecimal digits. The groups are separated by colon (:).  NOTE This function is displayed when [IPv6 Setting] is set to [On]. To enter "Default Gateway", set [RA (Stateless)] to [Off].
RA(Stateless)	Select whether to use RA (Stateless). Value: Off, On  NOTE This function is displayed when [IPv6 Setting] is set to [On]. Selecting [On] displays IP address in [IP Address 1 (to 5)] after restarting the network.
DHCPv6 Settings	Select whether to use the DHCP (IPv6) server. Value: Off, On  NOTE This function is displayed when [IPv6 Setting] is set to [On]. Selecting [On] displays IP address in [IP Address] after restarting the network.
Restart Network	Restarts the network.

 **IMPORTANT**

After changing the setting, restart the network or turn the machine OFF and then ON.

Wired Netwk. Set

[Menu] key > [▲] [▼] key > [Network] > [OK] key > [▲] [▼] key > [Wired Netwk. Set] > [OK] key

Configure wired network settings.

Item	Description
TCP/IP Settings	For details on setting value.  TCP/IP Settings (page 8-14)
LAN Interface	Specify the settings for the LAN interface to be used. Value: Auto, 10BASE-Half, 10BASE-Full, 100BASE-Half, 100BASE-Full, 1000BASE-T



 **IMPORTANT**





After changing the setting, restart the network or turn the machine OFF and then ON.





ProtocolSettings





[Menu] key > [▲] [▼] key > [Network] > [OK] key > [▲] [▼] key > [ProtocolSettings] > [OK] key







Configure protocol settings.



Item	Description
Bonjour	-
Off/On	Select whether to use Bonjour. ^{*1} Value: Off, On
Available Net.	-
Wi-Fi Direct ^{*2}	Set whether to enable this function for each network. Value: Disable, Enable
Wi-Fi ^{*2}	
Wired Network	
	 NOTE This function is displayed when [Off/On] is set to [On].
IP Filter (IPv4)	-
Off/On	Select whether to communicate using IP Filter (IPv4). ^{*1} Value: Off, On
IP Filter (IPv6)	-
Off/On	Select whether to communicate using IP Filter (IPv6). ^{*1} Value: Off, On
IPSec	-
Off/On	Select whether to use IPSec. ^{*1} Value: Off, On
NetBEUI	-
Off/On	Select whether to receive documents using NetBEUI. ^{*1} Value: Off, On
Available Net.	-
Wi-Fi Direct ^{*2}	Set whether to enable this function for each network. Value: Disable, Enable
Wi-Fi ^{*2}	
Wired Network	
	 NOTE This function is displayed when [Off/On] is set to [On].
SNMPv3	-
Off/On	Select whether to communicate using SNMPv3. ^{*1} Value: Off, On
Available Net.	-
Wi-Fi Direct ^{*2}	Set whether to enable this function for each network. Value: Disable, Enable
Wi-Fi ^{*2}	
Wired Network	
	 NOTE This function is displayed when [Off/On] is set to [On].

Item	Description
FTP(Server)	-
Off/On	Select whether to receive documents using FTP.* ¹ Value: Off, On
Available Net.	-
Wi-Fi Direct* ²	Set whether to enable this function for each network. Value: Disable, Enable
Wi-Fi* ²	
Wired Network	 NOTE This function is displayed when [Off/On] is set to [On].
SNMP	-
Off/On	Select whether to communicate using SNMP.* ¹ Value: Off, On
Available Net.	-
Wi-Fi Direct* ²	Set whether to enable this function for each network. Value: Disable, Enable
Wi-Fi* ²	
Wired Network	 NOTE This function is displayed when [Off/On] is set to [On].
SMTP	-
Off/On	Select whether to send E-mail using SMTP. Value: Off, On
POP3	-
Off/On	Select whether to receive E-mail using POP3. Value: Off, On
RAW Port	-
Off/On	Select whether to receive documents using RAW Port.* ¹ Value: Off, On
Available Net.	-
Wi-Fi Direct* ²	Set whether to enable this function for each network. Value: Disable, Enable
Wi-Fi* ²	
Wired Network	 NOTE This function is displayed when [Off/On] is set to [On].
LPD	-
Off/On	Select whether to receive documents using LPD.* ¹ Value: Off, On
Available Net.	-
Wi-Fi Direct* ²	Set whether to enable this function for each network. Value: Disable, Enable
Wi-Fi* ²	
Wired Network	 NOTE This function is displayed when [Off/On] is set to [On].

Item	Description
IPP	-
Off/On	Selects whether to receive documents using IPP. To use the IPP protocol, select [Not Secure (IPP&IPPS)] on IPP Security under Security Settings from the Embedded Web Server RX.* ¹ Value: Off, On
Port Number	Specifies the port number used. The default port number is 631.* ¹ Value: 1 to 32767  NOTE This function is displayed when [Off/On] is set to [On] .
Available Net.	-
Wi-Fi Direct * ²	Set whether to enable this function for each network. Value: Disable, Enable
Wi-Fi * ²	
Wired Network	 NOTE This function is displayed when [Off/On] is set to [On] .
IPP Over SSL	-
Off/On	Select whether to use IPP to receive documents secured by SSL.* ^{1, *3} Value: Off, On  NOTE When selecting [On] , it also requires a certificate for SSL. the default certificate is the self-certificate of the machine. ▶ Embedded Web Server RX User Guide
Available Net.	-
Wi-Fi Direct * ²	Set whether to enable this function for each network. Value: Disable, Enable
Wi-Fi * ²	
Wired Network	 NOTE This function is displayed when [Off/On] is set to [On] .
HTTP	-
Off/On	Select whether to communicate using HTTP.* ¹ Value: Off, On
Available Net.	-
Wi-Fi Direct * ²	Set whether to enable this function for each network. Value: Disable, Enable
Wi-Fi * ²	
Wired Network	 NOTE This function is displayed when [Off/On] is set to [On] .

Item	Description
HTTPS	-
Off/On	Select whether to communicate using HTTPS. ^{*1, *3} Value: Off, On
Available Net.	-
Wi-Fi Direct^{*2}	Set whether to enable this function for each network. Value: Disable, Enable
Wi-Fi^{*2}	 NOTE
Wired Network	This function is displayed when [Off/On] is set to [On] .
LDAP	-
Off/On	Select whether to use LDAP. Value: Off, On
ThinPrint	-
Off/On	Select whether to use ThinPrint. ^{*1, *3} Value: Off, On
Port Number	Specifies the port number used. The default port number is 4000. ^{*1} Value: 1 to 32767  NOTE This function is displayed when [Off/On] is set to [On] .
ThinPrintOverSSL	To use the Thin Print over SSL protocol, set [Thin Print Over SSL] to [On] . ^{*1, *2} Value: Off, On  NOTE <ul style="list-style-type: none"> This function is displayed when [Off/On] is set to [On]. When selecting [On], it also requires a certificate for SSL. The default certificate is the self-certificate of the machine. ➔ Embedded Web Server RX User Guide
Available Net.	-
Wi-Fi Direct^{*2}	Set whether to enable this function for each network. Value: Disable, Enable
Wi-Fi^{*2}	 NOTE
Wired Network	This function is displayed when [Off/On] is set to [On] .
WSD-PRINT	-
Off/On	Set whether to use our proprietary web services. WIA driver, TWAIN driver and Network FAX driver use this Enhanced WSD web service. ^{*1} Value: Off, On
Available Net.	-
Wi-Fi Direct^{*2}	Set whether to enable this function for each network. Value: Disable, Enable
Wi-Fi^{*2}	 NOTE
Wired Network	This function is displayed when [Off/On] is set to [On] .

Item	Description
Enhanced WSD	-
Off/On	Set whether to use our proprietary web services.* ¹ Value: Off, On  NOTE Selecting [Off] will disable the functionality of WIA, TWAIN, and Network FAX driver.
Available Net.	-
Wi-Fi Direct^{*2}	Set whether to enable this function for each network. Value: Disable, Enable
Wi-Fi^{*2}	
Wired Network	 NOTE This function is displayed when [Off/On] is set to [On].
EnhancedWSD(SSL)	-
Off/On	Set whether to use our proprietary web services over SSL.* ^{1, *3} Value: Off, On  NOTE Selecting [Off] will disable the functionality of WIA, TWAIN and Network FAX drivers.
Available Net.	-
Wi-Fi Direct^{*2}	Set whether to enable this function for each network. Value: Disable, Enable
Wi-Fi^{*2}	
Wired Network	 NOTE This function is displayed when [Off/On] is set to [On].
REST	-
Off/On	Select whether to use REST.* ¹ Value: Off, On
Port Number	Specifies the port number used. The default port number is 9080.* ¹ Value: 1 to 32767  NOTE This function is displayed when [Off/On] is set to [On].
Available Net.	-
Wi-Fi Direct^{*2}	Set whether to enable this function for each network. Value: Disable, Enable
Wi-Fi^{*2}	
Wired Network	 NOTE This function is displayed when [Off/On] is set to [On].

Item	Description
REST over SSL	-
Off/On	Select whether to use REST secured by SSL. *1, *3 Value: Off, On  NOTE <ul style="list-style-type: none"> This function is displayed when [Off/On] is set to [On]. When selecting [On], it also requires a certificate for SSL. the default certificate is the self-certificate of the machine. ▶ Embedded Web Server RX User Guide
Port Number	Specifies the port number used. The default port number is 9081. *1 Value: 1 to 32767  NOTE This function is displayed when [Off/On] is set to [On].
Available Net.	-
Wi-Fi Direct*2	Set whether to enable this function for each network. Value: Disable, Enable
Wi-Fi*2	 NOTE This function is displayed when [Off/On] is set to [On].
Wired Network	

*1 The setting will be changed after restarting the device or network.

*2 This function is displayed when the optional Wireless Network Interface Kit is installed.

*3 Set "SSL" to [On] in SSL Setting.

▶ [SSL Setting \(page 8-31\)](#)

IMPORTANT

After changing the setting, restart the network or turn the machine OFF and then ON.

Primary Network

[Menu] key > [▲] [▼] key > [Network] > [OK] key > [▲] [▼] key > [Primary Network] > [OK] key

NOTE

This function is displayed when the optional Network Interface Kit (IB-50) or Wireless Network Interface Kit (IB-51 or IB-36) is installed.

Item	Description
Primary Network	Specify the network to be used for the send function, the network authentication and connecting to external address book. Value: Wi-Fi, Wired Network, Optional Network

Ping

[Menu] key > [▲] [▼] key > [Network] > [OK] key > [▲] [▼] key > [Ping] > [OK] key

Item	Description
Ping	Checks if communication with the destination by entering the host name or IP address of the destination is possible.

Restart Network

[Menu] key > [▲] [▼] key > [Network] > [OK] key > [▲] [▼] key > [Restart Network] > [OK] key

Item	Description
Restart Network	Restarts the network.

Optional Network

Configure settings for the optional Network Interface Kit or Wireless Network Interface Kit.



NOTE

This menu is displayed when the optional Network Interface Kit or Wireless Network Interface Kit is installed.

Wireless Network





[Menu] key > [▲] [▼] key > [Optional Network] > [OK] key > [▲] [▼] key > [Wireless Network] > [OK] key



NOTE

This function is displayed when the optional Wireless Network Interface Kit is installed.

Item	Description
ConnectionStatus	When the optional Wireless Network Interface Kit is installed, you can check the wireless LAN status.
Quick Setup	If the machine will connect to an access point that supports the automatic wireless network setup, connection settings can be configured by Quick Setup.
AvailableNetwork	Displays access points to which the machine can connect.
Push Button	If the access point supports the push button method, wireless settings can be configured using the push button. This setting executes push button, and the connection is started by pressing the push button on the access point. NOTE The push button method supports only the WPS.
PIN (Device)	Starts connection using the machine's PIN code. Enter the PIN code into the access point. The PIN code of the machine is automatically generated.
PIN (Terminal)	Starts connection using the PIN code of the access point. Enter the PIN code of the access point.

Item	Description
Custom Setup	The detailed settings for wireless LAN can be changed. You can check the connection with a wireless network by selecting [Connect].
Netwk Name(SSID)	Set the SSID (Service Set Identifier) of the wireless LAN to which the machine connects.  NOTE Up to 32 characters can be entered.
Connection Mode	Set the connection mode. Value: Ad Hoc, Infrastructure  NOTE Ad Hoc: Directly communicates with the device without going through an access point. This method cannot be used to connect to two or more devices. Infrastructure: Performs communication through an access point.
Channel	Set channel. Use [▲] or [▼] or the numeric keys to enter a number. Value: 1 to 11
Netwk Authentic.	Select network authentication type. To select other options, open the device home page from a computer. Value: Open, Shared, WPA-PSK^{*1}, WPA2-PSK^{*1}
Encryption	Select encryption settings. The setting values vary depending on the "Netwk Authentic." setting.
Data Encryption	Set the encryption method. When "Netwk Authentic." is set to [Open] or [Shared]: Value: Disable, WEP When "Netwk Authentic." is set to [WPA-PSK] or [WPA2-PSK]: Value: TKIP^{*2}, AES, Auto^{*2}
WEP Key	Register the WEP key. Select [Edit] and Enter the WEP Key using the numeric keys.  NOTE Up to 26 characters can be entered. ➔ Character Entry Method (page 11-10)
Preshared Key^{*3}	Register the Preshared Key. Select [Edit] and Enter the Preshared Key using the numeric keys.  NOTE The number of characters is between 8 and 64. ➔ Character Entry Method (page 11-10)

*1 Not displayed if you selected [**Ad Hoc**] for "Connection Mode".*2 Not displayed if you selected [**WPA2-PSK**] for "Netwk Authentic.".*3 Displayed if you selected [**WPA-PSK**] or [**WPA2-PSK**] for "Netwk Authentic.".

Basic

[Menu] key > [▲] [▼] key > [Optional Network] > [OK] key > [▲] [▼] key > [Basic] > [OK] key

Item	Description
TCP/IP Settings	For details on setting value. ➔ TCP/IP Settings (page 8-14) For the setting value of [Bonjour]. ➔ ProtocolSettings (page 8-16)
NetWare	Use NetWare to receive documents. Value: Off, On
AppleTalk	Selects whether to receive documents using AppleTalk.* ¹ Value: Off, On
IPSec	Select whether to use IPSec. Value: Off, On
LAN Interface	Select the LAN Interface type.* ¹ Value: Auto, 10BASE-Half, 10BASE-Full, 100BASE-Half, 100BASE-Full, 1000BASE-T  NOTE This function is displayed when the optional Network Interface Kit is installed.
MACAddressFilter	Select whether to use MAC Address Filter. ➔ Operation Guide for the optional Network Interface Kit Value: Off, On
Restart Network	Restarts the network card of the device.

*¹ The setting will be changed after restarting the device or network.

Device Common

Configures overall machine operation.

Language

[Menu] key > [▲] [▼] key > [Device Common] > [OK] key > [▲] [▼] key > [Language] > [OK] key

Item	Description
Language	Select the language displayed on the message display.

Def. Screen(Box)



[Menu] key > [▲] [▼] key > [Device Common] > [OK] key > [▲] [▼] key > [Def. Screen(Box)] > [OK] key

Item	Description
Def. Screen(Box)	Select the screen to be displayed when [Document Box] key is selected. Value: Custom Box, Job Box

Date Setting

[Menu] key > [▲] [▼] key > [Device Common] > [OK] key > [▲] [▼] key > [Date Setting] > [OK] key

Configure settings related to the date and time.

Item	Description
Date	Set the date for the location where you use the machine. Value: Year (2000 to 2037), Month (01 to 12), Day (01 to 31) ➔ Setting Date and Time (page 2-15)  NOTE If you change the date while using the trial version of an application, you will no longer be able to use the application.
Time	Set the date and time for the location where you use the machine. Value: Hour (00 to 23), Minute (00 to 59), Second (00 to 59) ➔ Setting Date and Time (page 2-15)  NOTE If you change the time while using the trial version of an application, you will no longer be able to use the application.
Date Format	Select the display format of year, month, and date. The year is displayed in Western notation. Value: Month/Day/Year, Day/Month/Year, Year/Month/Day
Time Zone	Set the time difference from GMT. Choose the nearest listed location from the list. If you select a region that utilizes summer time, configure settings for summer time. ➔ Setting Date and Time (page 2-15)
Summer Time	

Buzzer

[Menu] key > [▲] [▼] key > [Device Common] > [OK] key > [▲] [▼] key > [Buzzer] > [OK] key

Set options for buzzer sound during the machine operations.

Item	Description
Key Confirmation	Emit a sound when a key is selected on the operation panel. Value: Off, On
Job Finish	Emit a sound when a print job is normally completed. Value: Off, On
Ready	Emit a sound when the warm-up is completed. Value: Off, On
Warning	Emit a sound when errors occur. Value: Off, On
Keyboard Confirm	Emit a sound when a key on the optional USB keyboard is selected. Value: Off, On

RAM Disk Setting

[Menu] key > [▲] [▼] key > [Device Common] > [OK] key > [▲] [▼] key > [RAM Disk Setting] > [OK] key



NOTE

This function will not be displayed when the optional SSD is installed.

Item	Description
RAM Disk Setting	A RAM disk can be created and its size can be set. Creating a RAM disk makes it possible to print from a Job Box. Value RAM Disk Mode: Off, On RAM Disk Size: The setting range varies depending on the amount of memory installed and the option memory usage setting.



IMPORTANT

After changing the setting, restart the network or turn the machine OFF and then ON.

Format SSD

[Menu] key > [▲] [▼] key > [Device Common] > [OK] key > [▲] [▼] key > [Format SSD] > [OK] key

Format an optional SSD.

When an optional SSD is inserted into the printer for the first time, it must be formatted before use.



IMPORTANT

Formatting will destroy any existing data on a storage device including a used SSD.



NOTE

This function will not be displayed when the optional Data Security Kit is installed.

Format SD Card

[Menu] key > [▲] [▼] key > [Device Common] > [OK] key > [▲] [▼] key > [Format SD Card] > [OK] key

Format an optional SD/SDHC memory card.

A new SD card must be formatted before it can be used in the machine.

IMPORTANT

- Formatting will destroy any existing data on a storage device including a used SD card.
- If you have installed application, do not format the SD card to avoid the removal of the application in the SD card.

Display Bright. (Display Brightness)

[Menu] key > [▲] [▼] key > [Device Common] > [OK] key > [▲] [▼] key > [Display Bright.] > [OK] key

Item	Description
Display Bright.	Set the brightness of the message display. Value: Darker -2, Darker -1, Normal 0, Lighter +1, Lighter +2

Error Handling

[Menu] key > [▲] [▼] key > [Device Common] > [OK] key > [▲] [▼] key > [Error Handling] > [OK] key

Select whether to cancel or continue the job when error has occurred.

Item	Description
DuplexPaperError	Select what to do when duplex printing is not possible for the selected paper size and media type. Value 1-sided: Printed in 1-sided Display Error: Message to cancel printing is displayed.
Paper Mismatch	Select what to do when the selected paper size or type does not match paper size or type loaded in the specified paper source while printing from the computer by specifying the cassette or multi-purpose tray. Value Continue: The setting is ignored and the job is printed. Display Error: Message to cancel printing is displayed.
MP Tray Empty	Turn this setting to [On] if you want the error displayed when the MP tray is configured as the default paper source, and there is no paper in the MP tray, or turn it to [Off] not to have the error displayed. Value: Off, On

ColorToner Empty





[Menu] key > [▲] [▼] key > [Device Common] > [OK] key > [▲] [▼] key > [ColorToner Empty] > [OK] key





Item	Description
ColorToner Empty	Select whether printing is prohibited or the Print in Black and White setting is used for printing once the color toner runs out. Value: Stop printing, Print in B & W

Timer Setting

[Menu] key > [▲] [▼] key > [Device Common] > [OK] key > [▲] [▼] key > [Timer Setting] > [OK] key

Configure settings related to the time.

Item	Description
Auto Panel Reset	<p>If no jobs are run for a certain period of time, automatically reset settings and return to the default setting. Select to use Auto Panel Reset or not.</p> <p>Value: Off, On</p> <p> NOTE</p> <p>The time allowed to elapse before the panel is reset is set with the "PanelReset Timer".</p> <p>➔ PanelReset Timer (page 8-28)</p>
PanelReset Timer	<p>If you select [On] for Auto Panel Reset, set the amount of time to wait before Auto Panel Reset.</p> <p>Value: 5 to 495 seconds (in 5 second increments)</p> <p> NOTE</p> <p>This function is displayed when [Auto Panel Reset] is set to [On].</p>
Sleep Level Set.	-
Sleep Level (models except for Europe)	<p>Select the Sleep level.</p> <p>Set the Energy Saver mode to reduce power consumption even more than Quick Recovery mode.</p> <p>Value: Quick Recovery, Energy Saver</p> <p> NOTE</p> <p>When the optional Network Interface Kit is installed, this is not displayed.</p>
Status	<p>Set whether to use the Energy Saver mode for the following functions individually:</p> <ul style="list-style-type: none"> • Card Reader^{*1} • Application <p>Value: Off, On</p> <p> NOTE</p> <p>When the machine enters Energy Saver, the ID card cannot be recognized.</p>
Sleep Timer	<p>Set amount of time before entering Sleep.</p> <p>Value</p> <p>For Europe 1 to 120 minutes (1 minute increments)</p> <p>Except for Europe 1 to 240 minutes (1 minute increments)</p> <p>➔ Sleep and Auto Sleep (page 2-24)</p>

Item	Description												
Power Off Rule (models for Europe)	<p>Select whether or not the machine enters Power Off mode for the following function. Select [On] to set the Power Off mode.</p> <ul style="list-style-type: none"> • Network • USB Cable • USB Host • RAM Disk • NIC*² <p>Value: Off, On</p> <p> NOTE</p> <p>Even when any of the functions is set to [On], if [NIC] is set to [Off], the machine does not enter Power Off Mode.</p> <p>Even when [Network] or [USB Cable] is set to [Off], if the machine does not communicate with the other devices, the machine will enter Power Off Mode.</p>												
Power Off Timer (models for Europe)	<p>Select whether to turn off the power automatically after a period of inactivity.</p> <p>Value: 1 hour, 2 hours, 3 hours, 4 hours, 5 hours, 6 hours, 9 hours, 12 hours, 1 day, 2 days, 3 days, 4 days, 5 days, 6 days, 1 week</p>												
WeeklyTimer Set.	<p>Configure settings for switching the machine to OFF and waking it automatically at a specified time for each day of the week.</p> <table border="1" data-bbox="167 920 1501 1469"> <tr> <td data-bbox="167 920 469 1010"> Weekly Timer </td> <td data-bbox="469 920 1501 1010"> <p>Select whether to use Weekly Timer.</p> <p>Value: Off, On</p> </td> </tr> <tr> <td data-bbox="167 1010 469 1061"> Schedule </td> <td data-bbox="469 1010 1501 1061"> <p>Specify the time for each day of the week at which the machine turns OFF.</p> </td> </tr> <tr> <td data-bbox="167 1061 469 1113"> Retry Settings </td> <td data-bbox="469 1061 1501 1113"> <p>-</p> </td> </tr> <tr> <td data-bbox="240 1113 469 1202"> Limited Retries </td> <td data-bbox="469 1113 1501 1202"> <p>Set whether or not retry of machine power-off is performed.</p> <p>Value: Off, On</p> </td> </tr> <tr> <td data-bbox="240 1202 469 1382"> Retry Times </td> <td data-bbox="469 1202 1501 1382"> <p>Set the number of retries for turning OFF this machine.</p> <p>Value: 0 to 10 times</p> <p> NOTE</p> <p>This function is displayed when [Limited Retries] is set to [On].</p> </td> </tr> <tr> <td data-bbox="240 1382 469 1469"> Retry Interval </td> <td data-bbox="469 1382 1501 1469"> <p>Set the retry interval.</p> <p>Value: 10 to 60 seconds (increments of 10 seconds)</p> </td> </tr> </table>	Weekly Timer	<p>Select whether to use Weekly Timer.</p> <p>Value: Off, On</p>	Schedule	<p>Specify the time for each day of the week at which the machine turns OFF.</p>	Retry Settings	<p>-</p>	Limited Retries	<p>Set whether or not retry of machine power-off is performed.</p> <p>Value: Off, On</p>	Retry Times	<p>Set the number of retries for turning OFF this machine.</p> <p>Value: 0 to 10 times</p> <p> NOTE</p> <p>This function is displayed when [Limited Retries] is set to [On].</p>	Retry Interval	<p>Set the retry interval.</p> <p>Value: 10 to 60 seconds (increments of 10 seconds)</p>
Weekly Timer	<p>Select whether to use Weekly Timer.</p> <p>Value: Off, On</p>												
Schedule	<p>Specify the time for each day of the week at which the machine turns OFF.</p>												
Retry Settings	<p>-</p>												
Limited Retries	<p>Set whether or not retry of machine power-off is performed.</p> <p>Value: Off, On</p>												
Retry Times	<p>Set the number of retries for turning OFF this machine.</p> <p>Value: 0 to 10 times</p> <p> NOTE</p> <p>This function is displayed when [Limited Retries] is set to [On].</p>												
Retry Interval	<p>Set the retry interval.</p> <p>Value: 10 to 60 seconds (increments of 10 seconds)</p>												
Auto Err. Clear	<p>If an error occurs during processing, processing stops to wait for the next step to be taken by the user. In the Auto Error Clear mode, automatically clear the error after a set amount of time elapses.</p> <p>Value: Off, On</p>												
Err. Clear Timer	<p>If you select [On] for Auto Error Clear, set the amount of time to wait before automatically clearing errors.</p> <p>Value: 5 to 495 seconds (in 5 second increments)</p> <p> NOTE</p> <p>This function is displayed when [Auto Err. Clear] is set to [On].</p>												

Item	Description
FormFeed TimeOut	Receiving print data from the computer, the machine may sometimes wait if there is no information signaling that the last page does not have any more data to be printed. When the preset timeout passes, the machine automatically prints paper. The options are between 5 and 495 seconds. Value: 5 to 495 seconds (in 5 second increments)
Ping Timeout	Set the time until timeout occurs when [Ping] is executed in "Network". Value: 1 to 30 seconds (in 1 second increments)

*1 Displayed only when the optional Card Authentication Kit is activated.

*2 Displayed when the optional Network Interface Kit or Wireless Network Interface Kit is installed.

Disp. Status/Log

[Menu] key > [▲] [▼] key > [Device Common] > [OK] key > [▲] [▼] key > [Disp. Status/Log] > [OK] key

Item	Description
Disp. Status/Log	Set the display method of the Status/Log.
JobsDetailStatus	Value: Show All, My Jobs Only, Hide All
Jobs Log	Value: Show All, My Jobs Only, Hide All

USB KeyboardType

[Menu] key > [▲] [▼] key > [Device Common] > [OK] key > [▲] [▼] key > [USB KeyboardType] > [OK] key

Item	Description
USB KeyboardType	Select the type of USB keyboard that you want to use. Value: US, Europe US, France, Germany, UK-English

Bluetooth Set.

[Menu] key > [▲] [▼] key > [Device Common] > [OK] key > [▲] [▼] key > [Bluetooth Set.] > [OK] key

Item	Description
Off/On	Use Bluetooth Keyboard. Value: Off, On
Search Device	Select the keyboard to be used.

Low Toner Alert

[Menu] key > [▲] [▼] key > [Device Common] > [OK] key > [▲] [▼] key > [Low Toner Alert] > [OK] key

Item	Description
Low Toner Alert	Set the amount of remaining toner to notify the administrator when to order a toner when the toner is running low. Value: Off, On Toner Level: Set the toner level for notification of low toner. The setting range is 5 to 100% (in 5% increments). Displayed when [Off/On] is set to [On].
	 NOTE Selecting [Off] alerts you low toner when the amount of remaining toner becomes 5%.

Security

The security functions can be set up to protect printer operation and the print data.

Network Security

[Menu] key > [▲] [▼] key > [Security] > [OK] key > [▲] [▼] key > [Network Security] > [OK] key

SSL Setting

Item	Description
SSL	Select the SSL server settings. Value Off/On: Off, On

I/F Block Set.

[Menu] key > [▲] [▼] key > [Security] > [OK] key > [▲] [▼] key > [I/F Block Set.] > [OK] key

This allows you to protect this machine by blocking the interface with external devices such as USB hosts or optional interfaces.

Item	Description
USB Host	This locks and protects the USB port (USB host). Value: Unblock, Block
USB Device	This locks and protects the USB interface connector (USB Device). Value: Unblock, Block
Option I/F	This locks and protects the optional interface slots. Value: Unblock, Block
USB Storage	This locks and protects the USB memory slot. Value: Unblock, Block  NOTE This function is available when USB Host is set to [Unblock].

IMPORTANT

After changing the setting, restart the network or turn the machine OFF and then ON.

Security Level





[Menu] key > [▲] [▼] key > [Security] > [OK] key > [▲] [▼] key > [Security Level] > [OK] key



Item	Description
Security Level	Specify the security level. Value High: This is the security setting we recommend. Use this setting normally. Low: This mode is used during maintenance. Do not use normally. Very High: In addition to [High] setting, this setting disables the machine settings to be changed from external command.

Data Security

[Menu] key > [▲] [▼] key > [Security] > [OK] key > [▲] [▼] key > [Data Security] > [OK] key

Configure settings for data stored in the optional SSD and machine's memory.

Item	Description
SSD Initializ.	<p>This changes security function settings.</p> <p> NOTE</p> <ul style="list-style-type: none"> This function is displayed when the optional SSD is installed and the optional Data Security Kit is activated. Input of the security password is required to change security function settings. The initial setting for the Security Password is "000000".
Security Passwd	<p>You can customize the security password so that only the administrator can use the security kit. Enter a password that uses six to 16 alphanumeric characters and symbols. You will need to enter the password again for confirmation.</p> <p> IMPORTANT</p> <p>Avoid any easy-to-guess numbers for the security password (e.g. 11111111 or 12345678).</p>
Initialization	<p>This can be used to delete all the data stored in the SSD. Overwrite all the data stored in the SSD when disposing of the machine.</p> <p> IMPORTANT</p> <p>If you accidentally turn the power switch off during initialization, the SSD might possibly crash or initialization might fail.</p> <p> NOTE</p> <p>If you accidentally turn off power during initialization, turn it back on. Initialization will restart automatically.</p>

Item	Description
DataSanitization	<p>Return the following information registered in the machine to the factory defaults.</p> <ul style="list-style-type: none"> • System settings • Data saved in Custom Box • Optional applications <p> IMPORTANT</p> <p>Data saved in an application or SD card cannot be erased. To erase data on an SD card, you must format the SD card.</p> <p>➔ Format SD Card (page 8-27)</p> <p> NOTE</p> <ul style="list-style-type: none"> • Once in progress, the processing cannot canceled. • Before executing this function, disconnect modular, network, and other cables. • Before performing this function, set all interface block settings to [Unblock]. ➔ I/F Block Set. (page 8-31) • Do not turn off the main power switch while sanitizing the data. If the main power is turned off during data erasing, erasing will be executed automatically when the power is restored, however, complete erasure cannot be guaranteed.
Run Immediately	Data Sanitization will be performed.
Schedule	<p>Completely erase address and image data saved in the device at the scheduled time.</p> <p>Value: Off, On</p> <p>If [On] is selected, set the date and time that sanitization is to be performed. The setting range is Year (2000 to 2037), Month (1 to 12), Day (1 to 31), Hour (00 to 23).</p>
Device Use	<p>The device use restriction after the data sanitization is completed.</p> <p>The device cannot be used if [Prohibit] is selected.</p> <p>Value: Permit, Prohibit</p>

User/Job Account

[Menu] key > [▲] [▼] key > [User/Job Account] > [OK] key

Configure settings related to machine management.

➔ [Overview of User Login Administration \(page 9-2\)](#)

[Overview of Job Accounting \(page 9-14\)](#)

[Unknown ID Job \(page 9-27\)](#)

Adjust/Maint.

[Menu] key > [▲] [▼] key > [Adjust/Maint.] > [OK] key

Adjust printing quality and conduct machine maintenance.

Item	Description
Quiet Mode	Lower print speed for quiet processing.
Quiet Mode	Set the Quiet Mode. Select this mode when the running noise is uncomfortable. Value: Off, On
Each Job	It is possible to set the use of Quiet Mode for each job. Set whether or not to permit the setting for each job. Value: Permit, Prohibit
ColorCalibration	This machine contains a calibration function that automatically makes adjustments to compensate for changes that occur over time due to variations in the ambient temperature and humidity. This function can be used for fine adjustment of tone and color drift to print in the optimum color. ➔ ColorCalibration (page 10-20) If color tone does not improve or color drift does not improve after executing this color adjustment, refer to the following: ➔ Color Registration Procedure (page 10-20)
Color Regist.	When first installing the machine or moving it to a new location, color drift during printing may occur. Use this function to correct the color position of each of cyan, magenta and yellow to resolve color drift. ➔ Color Registration Procedure (page 10-20)
Restart	Restart the CPU without turning the power switch off. Use this to deal with any unstable operation by the machine. (Same as the computer restart.)
Service Setting	Settings for machine maintenance and inspection. This menu is primarily used by service technicians to perform maintenance.

Op Functions

[Menu] key > [▲] [▼] key > [Op Functions] > [OK] key

Item	Description
Op Functions	You can use the optional applications installed on this machine. ➔ Optional Applications (page 11-8)

Software

[Menu] key > [▲] [▼] key > [Software] > [OK] key

Item	Description
Software	Check the machine's system and engine software versions.

9 User Authentication and Accounting (User Login, Job Accounting)

This chapter explains the following topics:

Overview of User Login Administration	9-2
Enabling User Login Administration	9-3
Setting User Login Administration	9-5
Adding a User (Local User List)	9-5
Changing User Properties	9-6
User Login Administration for Printing	9-8
NW User Property (Obtain Network User Property)	9-10
ID Card Settings	9-11
PIN Login Settings	9-12
Using User Login Administration	9-13
Login/Logout	9-13
Overview of Job Accounting	9-14
Enabling Job Accounting	9-15
Job Accounting Access	9-16
Setting an Account	9-17
Adding an Account	9-17
Restricting the Use of the Machine	9-18
Editing an Account	9-19
Deleting an Account	9-20
Job Accounting for Printing	9-21
Configuring Job Accounting	9-23
Apply Limit	9-23
Counting the Number of Pages Printed	9-24
Print Accounting Report	9-25
Using Job Accounting	9-26
Login/Logout	9-26
Unknown ID Job	9-27

Overview of User Login Administration

User login administration specifies how the user access is administered on this machine. Enter a correct login user name and password for user authentication to login.

- 1 Enable User Login Administration ([page 9-3](#))

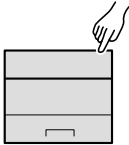

- 2 Set the user ([page 9-5](#))

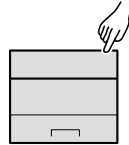

- 3 Enter the login user name and password and execute the job ([page 9-13](#))

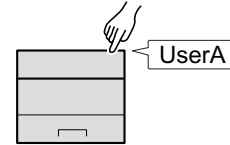

Access are in three levels - "User", "Administrator", and "Machine Administrator". The security levels can be modified only by the "Machine Administrator".

To manage the job account from PC

In addition to the above settings, the following are necessary to manage the job account from PC.

To Manage the Users to Print from PCs

Printer driver settings are necessary to manage the users that print on the machine from PCs.

- 1 Set the User Login Administration on the printer driver ([page 9-8](#))
- 2 Print

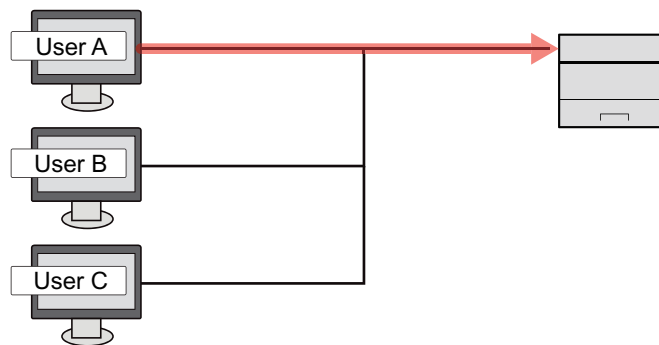

Enabling User Login Administration

This enables user login administration.

1 Display the screen.

- 1 [Menu] key > [▲] [▼] key > [User/Job Account] > [OK] key

NOTE

If the login user name entry screen appears during operations, enter a login user name and password, and select [Login]. For this, you need to login with administrator privileges.

The factory default login user name and login password are set as shown below.

	P-C3562DN	P-C4072DN
Login User Name:	3500	4000
Login Password:	3500	4000

- 2 [▲] [▼] key > [User Login Set.] > [OK] key

2 Configure the settings.

- 1 [▲] [▼] key > [User Login] > [OK] key > [▲] [▼] key > [Login Type] > [OK] key > [▲] [▼] key > [Netwk Authentic.] > [OK] key

NOTE

Select [Off] to disable user login administration.

- 2 [▲] [▼] key > [Netwk Auth. Set.] > [OK] key > [▲] [▼] key > [Server Type.] > [OK] key > [▲] [▼] key > [NTLM], [Kerberos] or [Ext.] > [OK] key > [▲] [▼] key > [Host Name] > [OK] key

- 3 Enter the host name (64 characters or less) for the Authentication Server and select the [OK] key.

- 4 Select the domain name for the Authentication Server, and select the [OK] key.

If the domain has not been set, select the number where "-----" is displayed and select [Menu]. Select [Edit] and select the [OK] key then enter the domain name (in 256 characters or less). Select the [OK] key and the domain will be registered.

To edit or delete a domain name that has already been registered, select that domain name and select [Menu].

NOTE

Up to 10 domain names can be registered.

- 5 When selecting [Ext.] as the server type, select [▲] [▼] key > [Port] > [OK] key.

- 6 Enter the port number and select the **[OK]** key.



NOTE

If the login user name and password are rejected, check the following settings.

- Network Authentication setting of the machine
- User property of the Authentication Server
- Date and time setting of the machine and the Authentication Server

If you cannot login because of the setting of the machine, login with any administrator registered in the local user list and correct the settings.

Setting User Login Administration

This registers, alters and deletes users and configures the settings for User Login Administration.

Adding a User (Local User List)

Use aQrate to register new users.

➔ [aQrate Install Manual](#)



NOTE

By default, one of each default user with machine administrator rights and administrator privileges is already stored. Each user's properties are:

Machine Administrator

User Name: DeviceAdmin
Login User Name: P-C3562DN: 3500 P-C4072DN: 4000
Login Password: P-C3562DN: 3500 P-C4072DN: 4000
Access Level: Machine Administrator

Administrator

User Name: Admin
Login User Name: Admin
Login Password: Admin
Access Level: Administrator

* Upper case and lower case letters are distinguished (case sensitive).

It is recommended to periodically change the user name, login user name and login password regularly for your security.

Changing User Properties

User properties can be changed. The information that can be changed is the "Login User Name" and "Login Password".

NOTE

To change the user information of the machine administrator, you must log in with machine administrator authority. You can only view user information if you log in as a regular user.

The factory default login user name and login password are set as shown below.

	P-C3562DN	P-C4072DN
Login User Name:	3500	4000
Login Password:	3500	4000

1 Display the screen.

- 1 [Menu] key > [▲] [▼] key > [User/Job Account] > [OK] key

NOTE

If the login user name entry screen appears during operations, enter a login user name and password, and select [Login]. For this, you need to login with administrator privileges.

The factory default login user name and login password are set as shown below.

	P-C3562DN	P-C4072DN
Login User Name:	3500	4000
Login Password:	3500	4000

- 2 [▲] [▼] key > [User Login Set.] > [OK] key > [▲] [▼] key > [Local User List] > [OK] key

2 Change the user properties.

Changing user properties

- 1 Select the user whose properties you wish to change, and the [OK] key.
- 2 Change the user information.

Select "Login User Name" or "Login Password" [Edit], enter the information, and select the [OK] key.

Select the [▶] key to view the next screen. Select the [◀] key to return to the previous screen. You can browse through "User Names".

Item	Description
User Name	Displays the name shown on the user list.
Login User Name	Displays the login user name that is entered at login.
Login Password	Changes the password that is entered at login. Up to 64 characters can be entered.

NOTE

When the logged in user does not have administrator authority, only the information of that user can be changed.

- 3 Select the [OK] key.

The user information is changed.

Deleting a user

To delete a user, use aQrate.

➔ [aQrate Install Manual](#)

User Login Administration for Printing

It is possible to manage the users that print on this machine from a PC.

Setting Printer Driver

To manage the users that print on this machine from a PC, the following settings are necessary in the printer driver. Instructions are based on interface elements as they appear in Windows 8.1.

1 Display the screen.

- 1 Select **[Settings]** in charms on Desktop, and select **[Control Panel]**, and then **[Devices and Printers]**.

NOTE

In Windows 7, click **[Start]** button on the Windows, and then click **[Devices and Printers]**.

- 2 Right-click the printer driver icon of the machine, and click the **[Printer properties]** menu of the printer driver.
- 3 Click **[Administrator]** on the **[Device Settings]** tab.

2 Configure the settings.

- 1 Select **[User Login]** on the **[User Login]** tab.

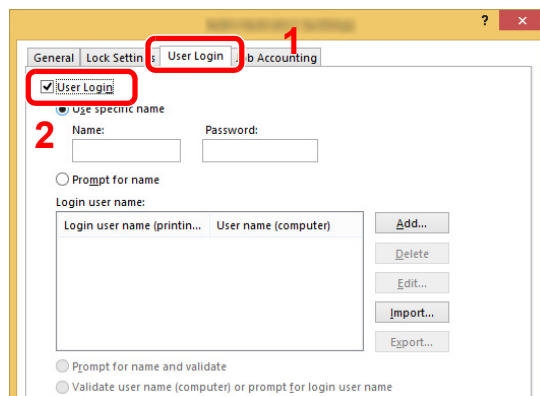

- 2 Set the User Login Administration.

[Use specific name]: This option can be used to specify a user name and password to use the same User login for every print job. If this option is selected, the user does not have to type the name and password for each print job.

[Prompt for name]: A screen for entering the user name and password will be displayed when attempting a printing. The user name and password must be entered each time a printing is attempted.

[Prompt for name and validate]: A screen for entering the user name and password will be displayed when attempting a printing. The user name and password stored in the Login user name list needs to be entered. The user name and password must be entered each time a printing is attempted.

[Validate user name (computer) or prompt for login user name]: When printing, the Windows user name is searched in the "Login user names" and printing is possible if the name is registered. If the name is not registered, the printing will be canceled for users with only user authority. If the user has administrator privileges, the screen to enter the user name and password will appear.

- 3 Click **[OK]**.



NOTE

For other settings of job accounting, refer to the following:

➔ **Printing System Driver User Guide**

NW User Property (Obtain Network User Property)

Set the required information to obtain the network user property from the LDAP server.

NOTE

- This setting only appears when the "Login Type" of "User Login" is set to [Netwk Authentic.] and the "Server Type" is set to [NTLM] or [Kerberos].

➔ [Enabling User Login Administration \(page 9-3\)](#)

- Setting to obtain network user information is performed from the operation panel. The details of the information to be obtained should be set with Embedded Web Server RX.

➔ [Embedded Web Server RX User Guide](#)

1 Display the screen.

1 [Menu] key > [▲] [▼] key > [User/Job Account] > [OK] key

NOTE

If the login user name entry screen appears during operations, enter a login user name and password, and select [Login]. For this, you need to login with administrator privileges.

The factory default login user name and login password are set as shown below.

	P-C3562DN	P-C4072DN
Login User Name:	3500	4000
Login Password:	3500	4000

2 [▲] [▼] key > [User Login Set.] > [OK] key

2 Configure the settings.

[▲] [▼] key > [NW User Property] > [OK] key

The setting items are as follows.

Item	Descriptions
Off/On	Set whether or not network user information is acquired. Value: Off, On
Authenticat Type	Set the authentication method. Value: Simple, SASL

ID Card Settings

If ID card authentication is enabled, select the authentication type.

NOTE

This functions appears when the Card Authentication kit is activated.

➔ [Card Authentication Kit\(B\) "Card Authentication Kit" \(page 11-3\)](#)

1 Display the screen.

1 [Menu] key > [▲] [▼] key > [User/Job Account] > [OK] key

NOTE

If the login user name entry screen appears during operations, enter a login user name and password, and select [**Login**]. For this, you need to login with administrator privileges.

The factory default login user name and login password are set as shown below.

	P-C3562DN	P-C4072DN
Login User Name:	3500	4000
Login Password:	3500	4000

2 [▲] [▼] key > [User Login Set.] > [OK] key

2 Configure the settings.

[▲] [▼] key > [ID Card Settings] > [OK] key

The following settings can be selected.

Item	Descriptions
Key Login	When ID card authentication is enabled, select whether or not login by keyboard is allowed. Value: Permit, Prohibit
Additional Auth.*1	Select whether or not to require password entry after authenticating by ID card. Value: Off, Use Password, Use PIN

*1 This function does not appear when the server type is set to [NTLM] or [Kerberos] in "Network Authentication".

PIN Login Settings

NOTE

This setting is only displayed when **[Network Authentication]** must be selected for the authentication method and the server type is set to **[Ext.]** in "Network Authentication".

➔ [Enabling User Login Administration \(page 9-3\)](#)

1 Display the screen.

1 [Menu] key > [▲] [▼] key > [User/Job Account] > [OK] key

NOTE

If the login user name entry screen appears during operations, enter a login user name and password, and select **[Login]**. For this, you need to login with administrator privileges.

The factory default login user name and login password are set as shown below.

	P-C3562DN	P-C4072DN
Login User Name:	3500	4000
Login Password:	3500	4000

2 [▲] [▼] key > [User Login Set.] > [OK] key

2 Configure the settings.

[▲] [▼] key > [PIN Login] > [OK] key > [▲] [▼] key > Select **[Off]** or **[On]** > [OK] key

Using User Login Administration

This section explains procedures while setting job accounting.

Login/Logout

If user login administration is enabled, the login user name and login password entry screen appears each time you use this machine.

Use the procedure below to login and logout.

Login

If the login user name entry screen appears during operations, log in by referring to the following:

➔ [Login \(page 2-13\)](#)

Logout

When the operations are complete, select the **[Logout]** key to return to the login user name and login password entry screen.

Overview of Job Accounting

Job accounting manages the print count accumulated by individual accounts by assigning an ID to each account.

- 1** Enable job accounting. (Refer to [page 9-15.](#))
- 2** Setting an account. (Refer to [page 9-17.](#))
- 3** Enter the assigned account ID when performing the job. (Refer to [page 9-13.](#))
- 4** Count the number of pages printed.

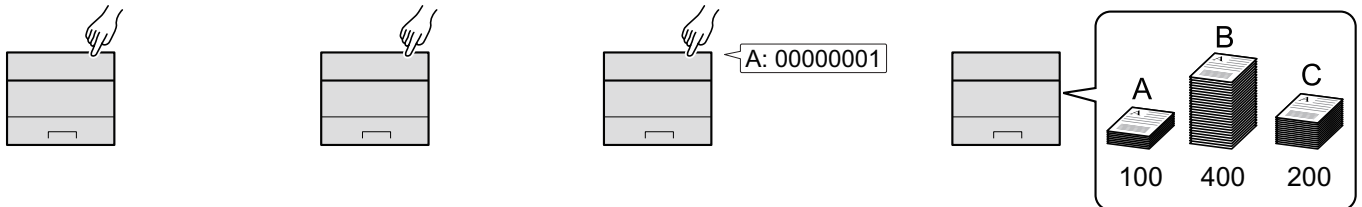

To manage the job account from PC

In addition to the above settings, the following are necessary to manage the job account from PC.

To Manage the Number of Sheets Used on Jobs Printed from a PC

To manage the number of jobs to be printed from the PC on the network, you need to configure settings by using the printer driver on the PC.

- 1** Set Job Accounting for the PC on the network by using the printer driver. (Refer to [page 9-21.](#))
- 2** Execute printing.
- 3** Count the number of pages printed.

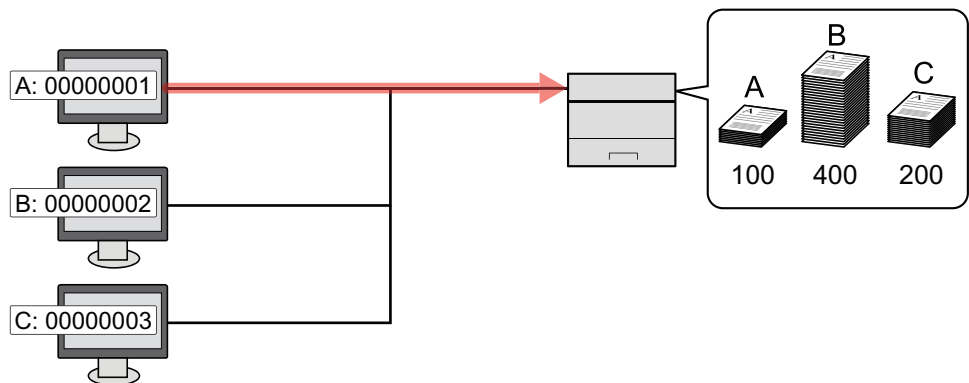

Enabling Job Accounting

Enable job accounting. Use the procedure below.

1 Display the screen.

- 1 [Menu] key > [▲] [▼] key > [User/Job Account] > [OK] key

NOTE

If the login user name entry screen appears during operations, enter a login user name and password, and select [**Login**]. For this, you need to login with administrator privileges.

The factory default login user name and login password are set as shown below.

	P-C3562DN	P-C4072DN
Login User Name:	3500	4000
Login Password:	3500	4000

- 2 [▲] [▼] key > [Job Account.Set.] > [OK] key

2 Configure the settings.

- [▲] [▼] key > [Job Accounting] > [OK] key > [▲] [▼] key > [On] > [OK] key

NOTE

- To disable job accounting, select [**Off**].
- When the display returns to System Menu default screen, logout is automatically executed and the screen to enter the Account ID appears. To continue the operation, enter the Account ID.

Job Accounting Access

Set the job accounting access.

1 Display the screen.

- 1 [Menu] key > [▲] [▼] key > [User/Job Account] > [OK] key

NOTE

If the login user name entry screen appears during operations, enter a login user name and password, and select [Login]. For this, you need to login with administrator privileges.

The factory default login user name and login password are set as shown below.

	P-C3562DN	P-C4072DN
Login User Name:	3500	4000
Login Password:	3500	4000

- 2 [▲] [▼] key > [Job Account.Set.] > [OK] key

2 Configure the settings.

- [▲] [▼] key > [AccountingAccess] > [OK] key > [▲] [▼] key > [Local] or [Network] > [OK] key

Setting an Account

You can add, change and delete an account and set the restriction for each account.

Adding an Account

Add a new account.

1 Display the screen.

- 1 [Menu] key > [▲] [▼] key > [User/Job Account] > [OK] key

NOTE

If the login user name entry screen appears during operations, enter a login user name and password, and select [Login]. For this, you need to login with administrator privileges.

The factory default login user name and login password are set as shown below.

	P-C3562DN	P-C4072DN
Login User Name:	3500	4000
Login Password:	3500	4000

- 2 [▲] [▼] key > [Job Account.Set.] > [OK] key > [▲] [▼] key > [Account. (Local)] > [OK] key > [▲] [▼] key > [Account. List] > [OK] key > [Add]

2 Enter the account ID.

Enter the account name > [OK] key

A new account is added on the account list.

NOTE

Any "Account ID" that has already registered cannot be used. Enter any other account ID.

Restricting the Use of the Machine

This section explains how to restrict the use of the machine by account or the number of sheets available.

Restriction Items

Item	Descriptions
Print Restrict Total	Limits the total number of sheets used for printing.
Print Restrict Full Color	Limits the number of pages used for color printing.

Applying Restriction

Restriction can be applied in the following modes:

Item	Descriptions
Off	No restriction is applied.
Counter Limit	Restricts the print counter in one-page increments up to 9,999,999 copies.
Reject Usage	Restriction is applied.

Editing an Account

This changes the registered account information.

1 Display the screen.

- 1 [Menu] key > [▲] [▼] key > [User/Job Account] > [OK] key



NOTE

If the login user name entry screen appears during operations, enter a login user name and password, and select [Login]. For this, you need to login with administrator privileges.

The factory default login user name and login password are set as shown below.

	P-C3562DN	P-C4072DN
Login User Name:	3500	4000
Login Password:	3500	4000

- 2 [▲] [▼] key > [Job Account.Set.] > [OK] key > [▲] [▼] key > [Account. (Local)] > [OK] key > [▲] [▼] key > [Account. List] > [OK] key

2 Edit an account.

- 1 Select the account you want to change and select the [OK] key.
- 2 [▲] [▼] key > [Detail/Edit] > [OK] key
- 3 Select the item you want to change, and select the [OK] key.
- 4 Refer to step 2 of "Adding an Account" and "Restricting the Use of the Machine" to change account information.
 - ➔ [Adding an Account \(page 9-17\)](#)
 - [Restricting the Use of the Machine \(page 9-18\)](#)
- 5 Select the [OK] key.

The account information is changed.

Deleting an Account

This deletes the account.

1 Display the screen.

- 1 [Menu] key > [▲] [▼] key > [User/Job Account] > [OK] key

NOTE

If the login user name entry screen appears during operations, enter a login user name and password, and select [Login]. For this, you need to login with administrator privileges.

The factory default login user name and login password are set as shown below.

	P-C3562DN	P-C4072DN
Login User Name:	3500	4000
Login Password:	3500	4000

- 2 [▲] [▼] key > [Job Account.Set.] > [OK] key > [▲] [▼] key > [Account. (Local)] > [OK] key > [▲] [▼] key > [Account. List] > [OK] key

2 Delete an account.

- 1 Select the account you want to delete and [OK] key.
- 2 [▲] [▼] key > [Delete] > [OK] key > [Yes]

The account is deleted.

Job Accounting for Printing

The number of jobs to be printed from the computer can be managed by Job Accounting.

Setting Printer Driver

To manage the number of jobs to be printed from the PC on the network, you need configure the following settings by using the printer driver on the PC. Instructions are based on interface elements as they appear in Windows 8.1.

1 Display the screen.

- 1 Select **[Settings]** in charms on Desktop, and select **[Control Panel]**, and then **[Devices and Printers]**.

NOTE

In Windows 7, click **[Start]** button on the Windows, and then click **[Devices and Printers]**.

- 2 Right-click the printer driver icon of the machine, and click the **[Printer properties]** menu of the printer driver.
- 3 Click **[Administrator]** on the **[Device Settings]** tab.

2 Configure the settings.

- 1 Select **[Job accounting]** on the **[Job Accounting]** tab.

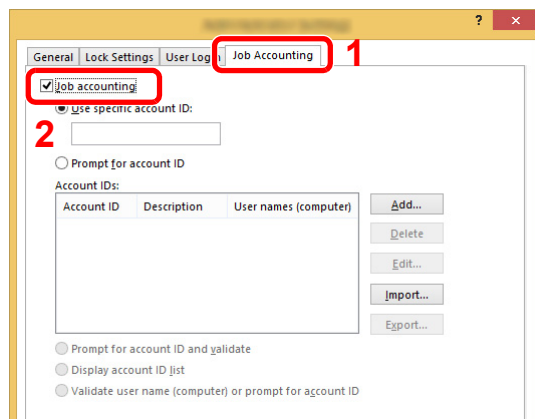

- 2 Set the Account ID.

[Use specific account ID]: Enter the Account ID. Printing will be performed using the entered Account ID. If this option is selected, the user does not have to enter the Account ID for each print job.

[Prompt for account ID]: A screen for entering the Account ID will be displayed when attempting a printing. The Account ID must be entered each time a printing is attempted.

[Prompt for account ID and validate]: A screen for entering the Account ID will be displayed when attempting a printing. The Account ID stored in the Account ID list needs to be entered. The Account ID must be entered each time a printing is attempted.

[Display account ID list]: The Account ID list is displayed when printing. The Account ID to be used needs to be selected from the list.

[Validate user name (computer) or prompt for account ID]: When printing, the Windows user name is searched in the "Login user names" and printing is possible if the name is registered. If the name is not registered, the printing will be canceled for users with only user authority. If the user has administrator privileges, the screen to enter the user name and password will appear.

- 3 Click **[OK]**.



NOTE

For other settings of job accounting, refer to the following:

➔ **Printing System Driver User Guide**

Configuring Job Accounting

Apply Limit

Use this to specify the action taken when a department exceeds its printing limits.

[Menu] key > [▲] [▼] key > [User/Job Account] > [OK] key > [▲] [▼] key > [Job Account.Set.] > [OK] key > [▲] [▼] key > [Apply Limit] > [OK] key

For details on each function, see the table below.

Item	Description
Apply Limit	This specifies how the machine behaves when the counter has reached the limit of restriction. The table below describes the action taken. Value Immediately: Job stops when the counter reaches its limit. Subsequently: Printing of the job continues but the subsequent job will be rejected.

Counting the Number of Pages Printed

This counts the number of pages printed. Counts are classified into Total Job Accounting and Each Job Accounting. A new count can also be started after resetting the count data which was stored for a certain period of time.

[Menu] key > [▲] [▼] key > [User/Job Account] > [OK] key > [▲] [▼] key > [Job Account.Set.] > [OK] key > [▲] [▼] key > [Account.(Local)] > [OK] key > [▲] [▼] key > [Each Job Account] > [OK] key

Each Job Account

This counts the number of pages for each account and resets the counts by account. When checking Each Job Accounting, select the account for which you want to check the count.

Types of the counts are as follows.

Item	Descriptions
Printed Pages	Displays the number of color printing and black and white printing, and the total number of pages used. You can also use "by Duplex" and "by Combine" to check the number of pages used.
Total	Displays the number sheets used for color printing, black & white printing, and the total of both.
Full Color	Displays the number of pages used for color printing.
Black & White	Displays the number of pages used for black and white printing.
Combine(None)	Displays the number of sheets used for printing without the Combine setting.
Combine(2in1)	Displays the number of sheets used for 2in1 printing.
Combine(4in1)	Displays the number of sheets used for 4in1 printing.
Duplex(1side)	Displays the number of sheets used for 1side printing.
Duplex(2side)	Displays the number of sheets used for 2side printing.
Counter Reset	Resets the counter. Select [Yes] in the confirmation screen.

Print Accounting Report

The total pages counted of all relevant accounts can be printed as an accounting report.

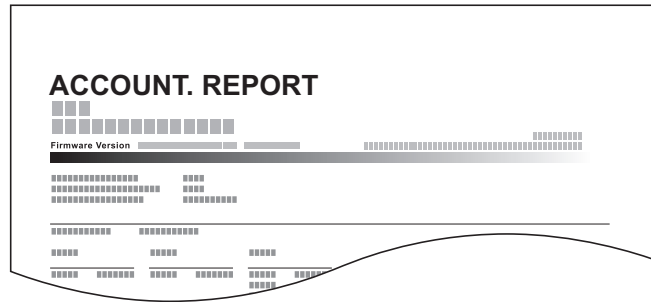

Use the procedure below to print a job accounting report.

1 Prepare paper.

Check that A4 or Letter paper is loaded in the cassette.

2 Display the screen.

1 [Menu] key > [▲] [▼] key > [User/Job Account] > [OK] key

NOTE

If the login user name entry screen appears during operations, enter a login user name and password, and select [Login]. For this, you need to login with administrator privileges.

The factory default login user name and login password are set as shown below.

	P-C3562DN	P-C4072DN
Login User Name:	3500	4000
Login Password:	3500	4000

2 [▲] [▼] key > [Job Account.Set.] > [OK] key > [▲] [▼] key > [Account. (Local)] > [OK] key

3 Print the report.

[▲] [▼] key > [Account. Report] > [OK] key > [Yes]

Accounting report is printed.

Using Job Accounting

This section explains procedures while setting job accounting.

Login/Logout

If job accounting is enabled, an account ID entry screen appears each time you use this machine.

Use the procedure below to login and logout.

Login

- 1 In the account ID entry screen, enter the account ID using the numeric keys and select the [OK] key.

 **NOTE**

- If you entered a wrong character, select the [Clear] key and enter the account ID again.
- If the entered account ID does not match the registered ID, a warning beep will sound and login will fail. Enter the correct account ID.

When the screen to enter the login user name and password appears

If user login administration is enabled, the screen to enter the login user name and password appears. Enter a login user name and password to login.

➔ [Adding a User \(Local User List\) \(page 9-5\)](#)

- 2 Proceed to complete the rest of the steps.

Logout

When the operations are complete, select the [Logout] key to return to the account ID entry screen.

Unknown ID Job

This specifies the behavior for handling the jobs sent with unknown or unsend login user names or User ID. If the User Login is set to invalid and Job Accounting is set to valid, follow the procedure when the Account ID is unknown.

The setting items are as follows.

Item	Descriptions
Permit	The job is permitted to be printed.
Reject	The job is rejected (not printed).

1 Display the screen.

- [Menu] key > [▲] [▼] key > [User/Job Account] > [OK] key

NOTE

If the login user name entry screen appears during operations, enter a login user name and password, and select [**Login**]. For this, you need to login with administrator privileges.

The factory default login user name and login password are set as shown below.

	P-C3562DN	P-C4072DN
Login User Name:	3500	4000
Login Password:	3500	4000

2 Configure the settings.

- [▲] [▼] key > [Unknown ID Job] > [OK] key > [▲] [▼] key > [Reject] or [Permit] > [OK] key

10 Troubleshooting

This chapter explains the following topics:

Regular Maintenance	10-2
Cleaning	10-2
Toner Container Replacement	10-3
Waste Toner Box Replacement	10-7
Troubleshooting	10-9
Solving Malfunctions	10-9
Responding to Messages	10-13
Adjustment/Maintenance	10-20
Clearing Paper Jams	10-25

Regular Maintenance

Cleaning

Clean the machine regularly to ensure optimum printing quality.



CAUTION

For safety, always unplug the power cord before cleaning the machine.

Paper Transfer Unit

The paper transfer unit should be cleaned each time the toner container and waste toner box are replaced. To maintain optimum print quality, it is also recommended that the inside of the machine be cleaned once a month as well as when the toner container is replaced.

Print problems such as soiling of the reverse side of printed pages may occur if the paper transfer unit becomes dirty.



CAUTION

Some parts are very hot inside the machine. Exercise caution as there is a risk of burn injury.

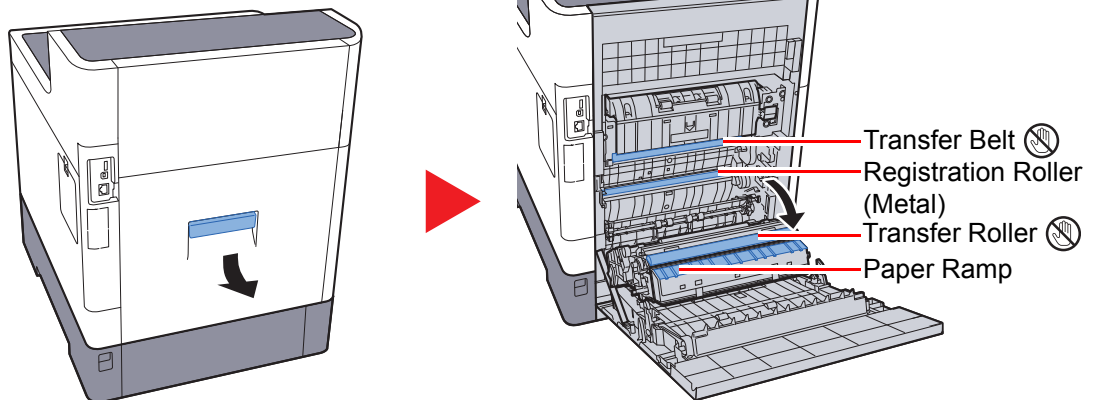

Wipe away the paper dust on the registration roller and the paper ramp using the cloth.



IMPORTANT

Be careful not to touch the transfer roller and transfer belt during cleaning as this may adversely affect print quality.

Toner Container Replacement

When toner runs low, "Toner is low." appears in the message display. Make sure you have a new toner container available for replacement.

When the message displays "Replace the toner.", replace the toner.

Frequency of Toner Container Replacement

The life of the toner containers depends on the amount of toner required to accomplish your printing jobs. According to ISO/IEC 19798 and EcoPrint switched off the toner container can print as follows (A4/Letter paper is assumed):

Toner Color	Life of the Toner Container (Printable pages)	
	P-C3562DN	P-C4072DN
Black	13,000 images	17,000 images
Cyan	11,000 images	13,000 images
Magenta	11,000 images	13,000 images
Yellow	11,000 images	13,000 images

NOTE

- The average number of pages that can be printed by the toner containers included with the machine are as follows.
P-C3562DN: Black (K): 6,000 images. Cyan (C), Magenta (M), Yellow (Y): 5,000 images.
P-C4072DN: Black (K): 8,000 images. Cyan (C), Magenta (M), Yellow (Y): 6,000 images.
- To maintain quality, we recommend using genuine own brand toner containers, which must pass numerous quality inspections.
- The memory chip in the toner container of this product stores information necessary for improving customer convenience, operation of the recycling system for used toner containers, and planning and development of new products. The stored information does not include information that makes it possible to identify individuals, and is only used anonymously for the above purposes.

CAUTION

Do not attempt to incinerate parts which contain toner. Dangerous sparks may cause burns.

Replacing the Toner Container

Installation procedures of the toner container is same for every color. The procedures here represent the yellow toner container.

1

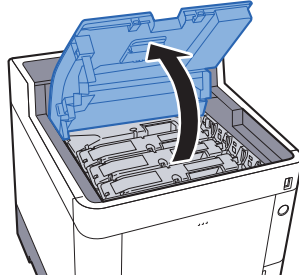

2

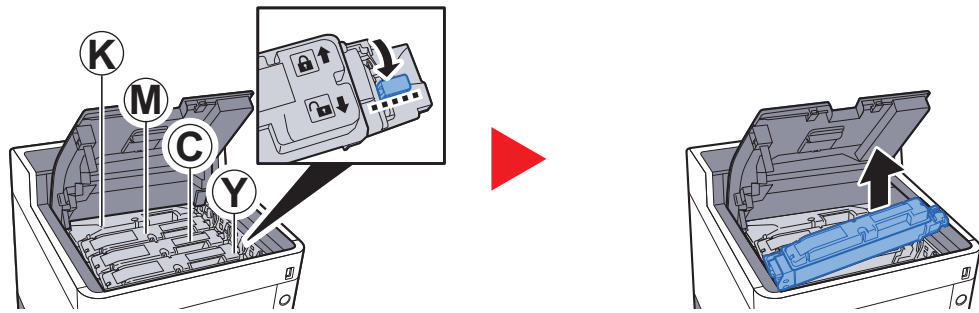

3

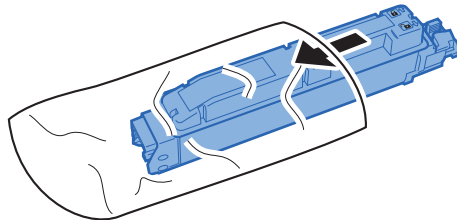

4

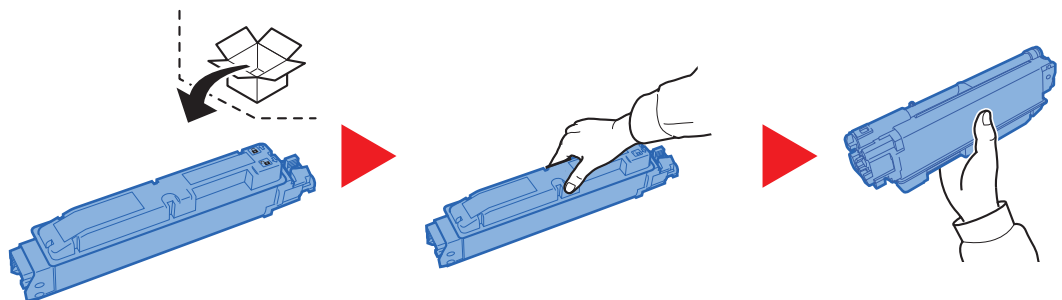

✔ **IMPORTANT**

Do not touch the points shown below.

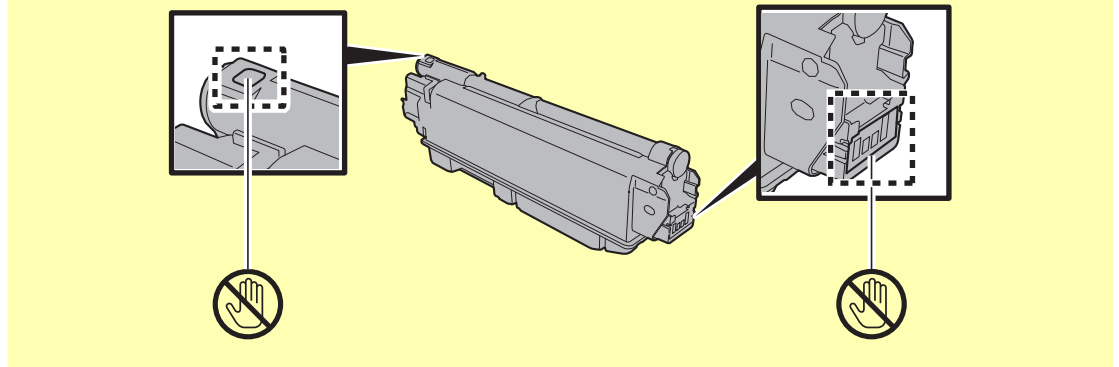

5

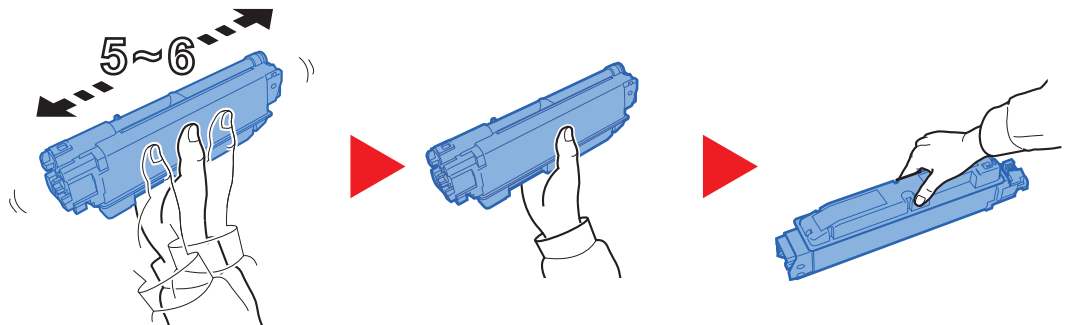

6

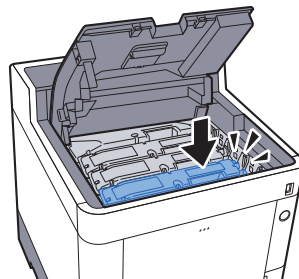

7

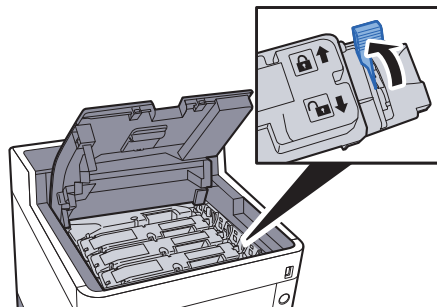

8

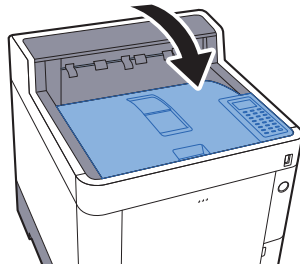

NOTE

- If the Upper Tray does not close, check that the new toner container is installed correctly (in step 6).
- Return the exhausted toner container to your dealer or service representative. The collected toner container will be recycled or disposed in accordance with the relevant regulations.

Waste Toner Box Replacement

When the waste toner box becomes full, immediately replace the waste toner box.



CAUTION

Do not attempt to incinerate parts which contain toner. Dangerous sparks may cause burns.

1

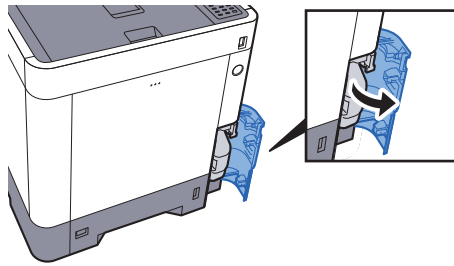

2

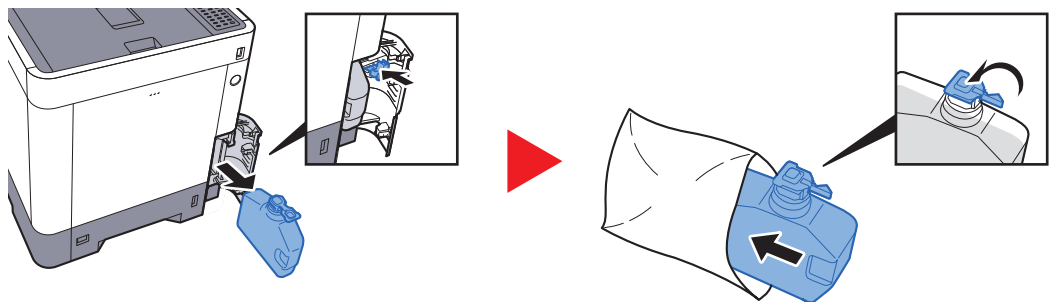

3

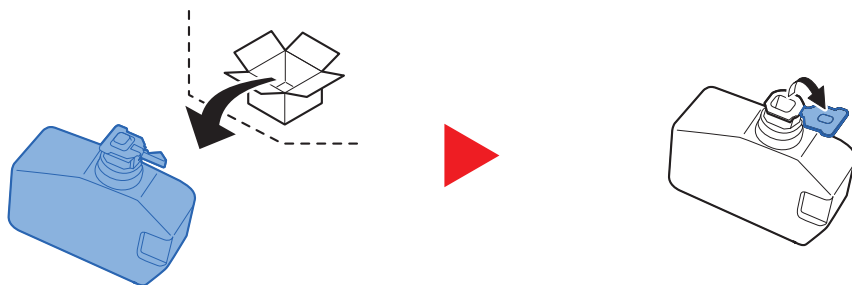

4

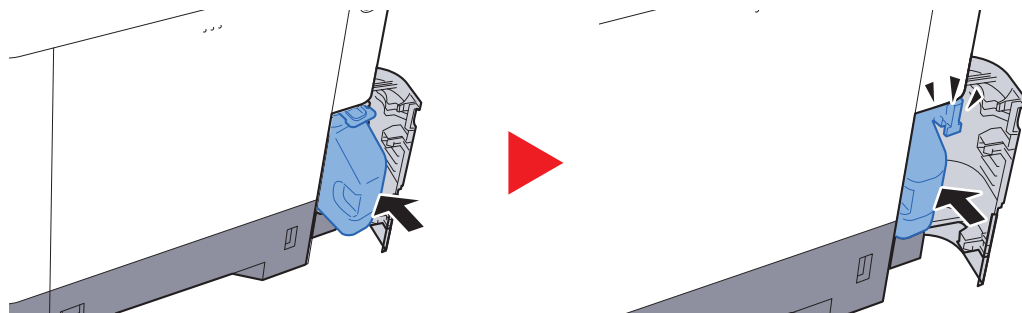

5

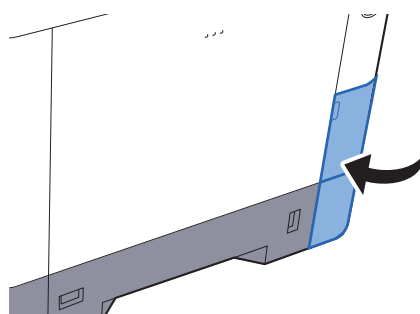

NOTE

Return the exhausted waste toner box to your dealer or service representative. The collected waste toner box will be recycled or disposed in accordance with the relevant regulations.

Troubleshooting

Solving Malfunctions



The table below provides general guidelines for problem solving.





If a problem occurs with your machine, look into the checkpoints and perform procedures indicated on the following pages. If the problem persists, contact your Service Representative.

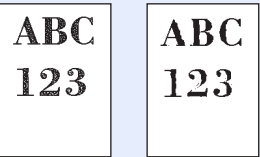

 **NOTE**

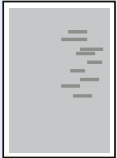
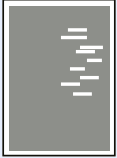

When contacting us, the serial number will be necessary. To check the serial number, refer to the following:

➔ [Checking the Equipment's Serial Number \(page i\)](#)

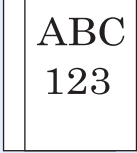
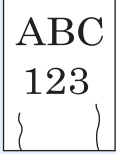
Symptom	Checkpoints	Corrective Actions	Reference Page
The screen does not respond when the main power switch is turned on.	Check the power cord.	Connect both ends of the power cord securely.	page 2-8
Blank sheets are ejected. 	Are the originals loaded correctly?	Check that the settings of the application software.	—
Printouts are totally too light. 	Is the paper damp?	Replace the paper with new paper.	page 3-2
	Is the toner distributed evenly within the toner container?	Shake the toner container from side to side several times.	page 10-3
	Is EcoPrint mode enabled?	Disable [EcoPrint] mode.	page 8-11
	—	Select the [Menu] key > [Adjust/Maint.] > [Service Setting] > [Drum], and then select [Yes].	—
	—	P-C4072DN: Select the [Menu] key > [Adjust/Maint.] > [Service Setting] > [Drum Heater], and then select [On].  NOTE This function cannot be turned on in some regions.	—
—	—	Make sure the paper type setting is correct for the paper being used.	page 8-9

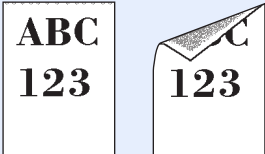
Symptom	Checkpoints	Corrective Actions	Reference Page
<p>Printouts are fuzzy. Printouts are cut off.</p> 	<p>Is the machine being used in conditions of very humid, or humidity or temperature rapidly changes?</p> <p>—</p> <p>—</p>	<p>Use in an environment that has suitable humidity.</p> <p>Select the [Menu] key > [Adjust/Maint.] > [Service Setting] > [Drum], and then select [Yes].</p> <p>P-C4072DN: Select the [Menu] key > [Adjust/Maint.] > [Service Setting] > [Drum Heater], and then select [On].</p> <p> NOTE This function cannot be turned on in some regions.</p>	<p>—</p> <p>—</p> <p>—</p>
<p>Images are skewed.</p> 	<p>Is the paper loaded correctly?</p>	<p>Check the position of the paper width guides.</p>	<p>page 3-4</p>
<p>Irregular horizontal lines appear in the image.</p> 	<p>—</p>	<p>P-C3562DN: Select the [Menu] key > [Adjust/Maint.] > [Service Setting] > [MC] and increase the adjustment value. Increase the adjustment value 1 level at a time from the current value. If there is no improvement after the value is increased by 1 level, increase by 1 level again. If there is still no improvement, return the setting to the original value.</p>	<p>—</p>
<p>The altitude is 1000 m or higher and irregular horizontal white lines appear in the image.</p> 	<p>—</p>	<p>Select the [Menu] key > [Adjust/Maint.] > [Service Setting] > [Altitude Adj.], and set to an elevation one level higher than the current setting.</p>	<p>—</p>
<p>The altitude is 1000 m or higher and dots appear in the image.</p> 	<p>—</p>	<p>Select the [Menu] key > [Adjust/Maint.] > [Service Setting] > [Altitude Adj.], and set to an elevation one level higher than the current setting.</p>	<p>—</p>

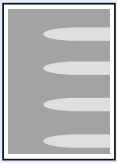
Symptom	Checkpoints	Corrective Actions	Reference Page
Paper often jams.	Is the paper loaded correctly?	Load the paper correctly.	page 3-2
	Is the paper of the supported type? Is it in good condition?	Remove the paper, turn it over, and reload it.	page 3-4
	Is the paper curled, folded or wrinkled?	Replace the paper with new paper.	page 3-4
	Are there any loose scraps or jammed paper in the machine?	Remove any jammed paper.	page 10-25
2 or more sheets are overlaps when ejected. (multi feed) 	—	Load the paper correctly.	page 3-2
Printouts are wrinkled. 	Is the paper loaded correctly?	Load the paper correctly.	page 3-2
	Is the paper damp?	Replace the paper with new paper.	page 3-2
Printouts are curled. 	Is the paper damp?	Replace the paper with new paper.	page 3-2
Cannot print.	Is the machine plugged in?	Plug the power cord into an AC outlet.	—
	Is the machine powered on?	Turn on the power switch.	page 2-9
	Are the USB cable and network cable connected?	Connect the correct USB cable and network cable securely.	page 2-7
Cannot print with USB memory. USB memory not recognized.	Is the USB host blocked?	Select [Unblock] in the USB host settings.	page 8-31
	—	Check that the USB memory is securely plugged into the machine.	—
Dirt on the top edge or back of the paper. 	Is the interior of the machine dirty?	Clean the interior of the machine.	page 10-2

Symptom	Checkpoints	Corrective Actions	Reference Page
<p>Part of the image is periodically faint or shows white lines.</p> 	— —	<p>Open and then close the rear cover.</p> <p>P-C3562DN: Select the [Menu] key > [Adjust/Maint.] > [Service Setting] > [MC] and decrease the adjustment value. Decrease the adjustment value 1 level at a time from the current value. If there is no improvement after the value is decreased by 1 level, decrease by 1 level again. If there is still no improvement, return the setting to the original value.</p>	<p>page 2-2</p> <p>—</p>
<p>Skewed-color printout.</p> 	— —	<p>Run [ColorCalibration].</p> <p>Run [Color Regist.].</p>	<p>page 10-20</p> <p>page 10-20</p>
<p>Colors appear different than you anticipated.</p>		<p>When printing from a computer</p> <p>Adjust the color using the printer driver.</p>	—
<p>The previous image remains and lightly printed.</p> 	—	<p>P-C3562DN: Select the [Menu] key > [Adjust/Maint.] > [Service Setting] > [MC] and increase the adjustment value. Increase the adjustment value 1 level at a time from the current value. If there is no improvement after the value is increased by 1 level, increase by 1 level again. If there is still no improvement, return the setting to the original value.</p>	—
<p>The color toner is empty.</p>	<p>Do you want to continue printing in black and white?</p>	<p>If the black toner is remained, the machine continues printing in black and white by selecting [Print in B & W] of [ColorToner Empty].</p>	<p>page 8-27</p>
<p>The machine is emitting steam in the area around the paper ejection slot.</p>	<p>Check the room temperature to see if it is low, or if damp paper was used.</p>	<p>Depending on the printing environment and the paper's condition, the heat generated during printing will cause the moisture in the paper to evaporate, and the steam emitted may look like smoke. This is not a problem, and you can continue printing. If the steam concerns you, raise the room temperature, or replace the paper with a newer, dryer paper.</p>	—

Responding to Messages

If the message display or the computer displays any of these messages, follow the corresponding procedure.

 **NOTE**

When contacting us, the serial number will be necessary. To check the serial number, refer to the following:

➔ [Checking the Equipment's Serial Number \(page i\)](#)

A

Message	Checkpoints	Corrective Actions	Reference Page
Account error. Press [OK].	—	Failed to specify Job Accounting when processing the job externally. The job is canceled. Select [OK].	—
Add paper in cassette #.	Is the indicated cassette out of paper?	The paper has run out in the paper source displayed. Supply paper according to the paper source displayed (paper cassettes, MP tray, or optional paper feeders).	page 3-4
Add paper in MP tray.	Is the paper of the selected size loaded in the multi purpose tray?		page 3-7

B

Message	Checkpoints	Corrective Actions	Reference Page
Box limit exceeded.*1	—	The specified box is full, and no further storage is available; Job is canceled. Try to perform the job again after printing or deleting data from the box.	—

*1 When Auto Error Clear is set to [On], processing resumes automatically after a set amount of time elapses. For details on Auto Error Clear, refer to the following:

➔ [Auto Err. Clear \(page 8-29\)](#)

C

Message	Checkpoints	Corrective Actions	Reference Page
Cannot connect to Authentication Server. Check the domain name.*1	—	Set machine time to match the server's time.	—
	—	Check the connection status with the server.	—
Cannot connect to the Server.	—	Check the connection status with the server.	—
Cannot connect to the USB device.	Is writing to a USB memory prohibited?	Connect a USB memory that can be written to.	—
Cannot duplex print on this paper.*1	Did you select a paper size/type that cannot be duplex printed?	Select [Alt] to select the available paper. Select [Continue] to print without using Duplex function.	—

Message	Checkpoints	Corrective Actions	Reference Page
Cannot execute this job. Restricted by Authentication settings.	—	This job is canceled because it is restricted by Authentication settings. Select [OK] .	—
Check cassette #.	—	Open and then close the indicated cassette.	—
Close rear cover #.	Is there any cover which is open?	Close the cover indicated on the screen.	—
Close the waste toner cover.			
Close top cover.			
Color toner is empty. Cannot print this document.	—	Replace the toner container using a new toner kit for the particular color.	page 10-3

*1 When Auto Error Clear is set to **[On]**, processing resumes automatically after a set amount of time elapses. For details on Auto Error Clear, refer to the following:

➔ [Auto Err. Clear \(page 8-29\)](#)

E

Message	Checkpoints	Corrective Actions	Reference Page
Error occurred. Turn the power switch off and on.	—	System error has occurred. Turn the main power switch OFF and then ON.	—

H

Message	Checkpoints	Corrective Actions	Reference Page
High temperature. Adjust room temp.	—	Adjust the temperature and the humidity of your room.	—

I

Message	Checkpoints	Corrective Actions	Reference Page
Incorrect account ID. Press [OK].*1	—	The account ID was incorrect when processing the job externally. The job is canceled. Select [OK] .	page 9-17
Incorrect ID.	—	The administrator ID entered to open the Security function or Job Accounting menu is not correct. Enter the correct administrator ID.	—
	—	The user ID entered for a private job is not correct. Check the user ID that you specified on the printer driver.	page 4-9 page 4-11

Message	Checkpoints	Corrective Actions	Reference Page
Incorrect password.	—	The password does not match the password set. Enter the correct password.	—
Incorrect login user name or password. Job is canceled.*1	—	The login user name or password was incorrect when processing the job externally. Enter the correct login user name or password.	—

*1 When Auto Error Clear is set to **[On]**, processing resumes automatically after a set amount of time elapses. For details on Auto Error Clear, refer to the following:

➔ [Auto Err. Clear \(page 8-29\)](#)

J

Message	Checkpoints	Corrective Actions	Reference Page
Job Accounting restriction exceeded. Press [OK].	Is the acceptable printing count restricted by Job Accounting exceeded?	The printing count exceeded the acceptable count restricted by Job Accounting. Cannot print any more. This job is canceled. Select [OK] .	page 9-23
Job not stored. Press [OK].	—	Printing using the Job Box function failed because there was insufficient space available on the SSD or RAM disk, or because the RAM disk was disabled when demounting the SSD. To print an error report and return the printer to the print-ready status, select [OK] .	—

K

Message	Checkpoints	Corrective Actions	Reference Page
KPDL error. Press [OK].*1	—	PostScript error has occurred. The job is canceled. Select [OK] .	—

*1 When Auto Error Clear is set to **[On]**, processing resumes automatically after a set amount of time elapses. For details on Auto Error Clear, refer to the following:

➔ [Auto Err. Clear \(page 8-29\)](#)

L

Message	Checkpoints	Corrective Actions	Reference Page
Load paper in cassette #. (paper size) (paper type)	Is the paper of the selected size or type loaded in the cassettes or multi purpose tray?	Load paper. Select [Alt.] to select the other paper source. Select the [Continue] key to print on the paper in the currently selected paper source.	page 3-4
Load paper in MP tray. (paper size) (paper type)			page 3-7
Low temperature. Adjust room temp.	—	Adjust the temperature and the humidity of your room	—

M

Message	Checkpoints	Corrective Actions	Reference Page
Machine failure. Call service.	—	An error has occurred in the machine. Make a note of the error code displayed on the message display, and contact your service representative.	—
Memory is full. Print job cannot be processed completely.*1	—	Unable to continue the job as the memory is used up. The print job cannot be processed completely. Select [OK] to cancel the job.	page 11-4

*1 When Auto Error Clear is set to **[On]**, processing resumes automatically after a set amount of time elapses. For details on Auto Error Clear, refer to the following:

➔ [Auto Err. Clear \(page 8-29\)](#)

N

Message	Checkpoints	Corrective Actions	Reference Page
No multi copies. Press [OK].	—	Multi copies cannot be printed because RAM disk is disabled or the SSD is not installed. The job is canceled. Select [OK] . Try adding more memory or installing SSD, and configuring the RAM disk settings.	—
Non-genuine Toner. Press [Help].	Is the installed toner container our own brand?	The manufacturer assumes no responsibility for damage caused by a non-genuine toner. We recommend that you only use genuine toner containers. When you want to use the toner container currently installed, select the [OK] key and the [Cancel] key simultaneously for 3 seconds or more.	—

P

Message	Checkpoints	Corrective Actions	Reference Page
Paper jammed at MP tray.	—	If a paper jam occurs, the machine will stop and the location of the jam will be indicated on the screen. Leave the machine on and select [Help] . Follow the instruction to remove the jammed paper.	page 10-25
Paper jammed in Cassette #			
Paper jammed in rear cover #.			
Paper jammed in the back of Cassette 1.			

Message	Checkpoints	Corrective Actions	Reference Page
Paper path error. Set cassette.	—	There is no paper cassette in the printer, or the cassette is not inserted properly. After reinserting the paper cassette, you should be able to print. When two or more optional feeders are installed and the lowest one is selected, the same message will appear if any of the upper paper feeder and the printer cassette is improperly installed.	—
Please wait. Refreshing drum...	—	The machine is under the adjustment to maintain its quality. Please wait.	—

R

Message	Checkpoints	Corrective Actions	Reference Page
RAM disk error. Press [OK].	—	An error has occurred on the RAM disk. Job is canceled. Select [OK] . The possible error codes and their descriptions are as follows. 04: Insufficient space on the RAM disk. If the optional RAM disk is installed, increase the RAM disk size by changing RAM Disk Setting in System Menu.	—
Replace MK.	—	Replace Maintenance Kit which is displayed on the message display. Replacement of the maintenance kit is necessary at every 200,000 images (for P-C3562DN), or 300,000 images (for P-C4072DN) of printing and requires professional servicing. Contact your Service Representative.	—
Restricted by Job Accounting. Press [OK].	—	This job is canceled because it is restricted by Job Accounting. Select [OK] .	page 9-23
Replace the toner. [C][M][Y][K]	—	Replace the toner container to our specified toner container.	page 10-3
Replace the toner. [C][M][Y] Job is canceled. B&W mode enabled.	—	Replace the toner container to our specified toner container. If not, select [OK] to cancel the job. The device prints in black and white for a while.	page 10-3

S

Message	Checkpoints	Corrective Actions	Reference Page
Shake the toner container. [C][M][Y][K]	—	Shake the toner container well and reinstall it.	page 10-3
SSD error. Press [OK].	—	An error has occurred on SSD. Job is canceled. Select [OK]. The possible error codes and their descriptions are as follows. 01: The amount of data that can be saved at once has been exceeded. Turn the power OFF/ON. If the error still occurs, divide the file into smaller files. If the error occurs after the file is divided, the specified file may be damaged. Delete the file. 04: Insufficient space on SSD to complete this operation. Move data or delete unneeded data.	—

T

Message	Checkpoints	Corrective Actions	Reference Page
The toner container is not locked or improperly installed.	—	The toner container is not installed correctly. Set it correctly.	page 10-3
Toner is low.[C][M][Y][K]	—	It is almost time to replace the toner container. Obtain a new toner container.	—
Top tray is full of paper. Remove the paper.	—	Remove paper from the top tray.	—

U

Message	Checkpoints	Corrective Actions	Reference Page
Unknown Toner Installed. PC [C][M][Y][K]	Does the installed toner container's regional specification match the machine's?	Install the specified toner container.	—
USB memory error. Press [OK].	—	An error occurred in the removable memory. The job stopped. Select [OK] . The possible error codes and their descriptions are as follows. 01: The amount of data that can be saved at once has been exceeded. Turn the power OFF/ON. If the error still occurs, the removable memory is not compatible with the machine. Use the removable memory formatted by this machine. If the removable memory cannot be formatted, it is damaged. Connect a compatible removable memory.	—

W

Message	Checkpoints	Corrective Actions	Reference Page
Waste toner box is full or placed improperly.	—	The waste toner box is not installed correctly. Set it correctly.	page 10-7
	Is the waste toner box full?	Replace the waste toner box.	page 10-7

Y

Message	Checkpoints	Corrective Actions	Reference Page
You cannot use this box. Job is canceled.	—	You cannot use the specified box. Job is canceled. Select [OK] .	—

Adjustment/Maintenance

Color Calibration

This machine contains a calibration function that automatically makes adjustments to compensate for changes that occur over time due to variations in the ambient temperature and humidity. So that the highest quality color printing can be maintained, this color calibration operation is carried out automatically each time the power to the machine is turned on. If color tone does not improve or color drift does not improve after executing this color adjustment, perform color print position correction on the following:

➔ [Color Registration Procedure \(page 10-20\)](#)

1 Display the screen.

[Menu] key > [▲] [▼] key > [Adjust/Maint.] > [OK] key > [▲] [▼] key > [Color Calibration] > [OK] key

2 Perform the Color Calibration.

Select [Yes] to execute Color Calibration.

"Completed." is displayed and the screen returns to the Adjust/Maint. menu.

Color Registration Procedure

This function is available to resolve color drift. If it is not resolved by normal registration or to perform more detailed settings, use the detailed settings.



NOTE

To perform color registration, verify that either Letter or A4 paper is loaded into a cassette.



IMPORTANT

Before performing color registration, be sure to perform [Color Calibration on page 10-20](#). If color drift remains, perform color registration. By performing color registration without performing Color Calibration, the color drift will be resolved once, however, it may cause the serious color drift later.

Normal Registration

1 Display the screen.

[Menu] key > [▲] [▼] key > [Adjust/Maint.] > [OK] key > [▲] [▼] key > [Color Regist.] > [OK] key > [▲] [▼] key > [Normal] > [OK] key

2 Print the chart.

[▲] [▼] key > [Print Chart] > [OK] key > [Yes]

A chart is printed. On the chart, for each of M (magenta), C (cyan) and Y (yellow), 3 chart types are printed on one sheet: H-L (left), V (vertical), H-R (right).

After printing, you will return to the advanced menu for color printing position correction.

Chart Example

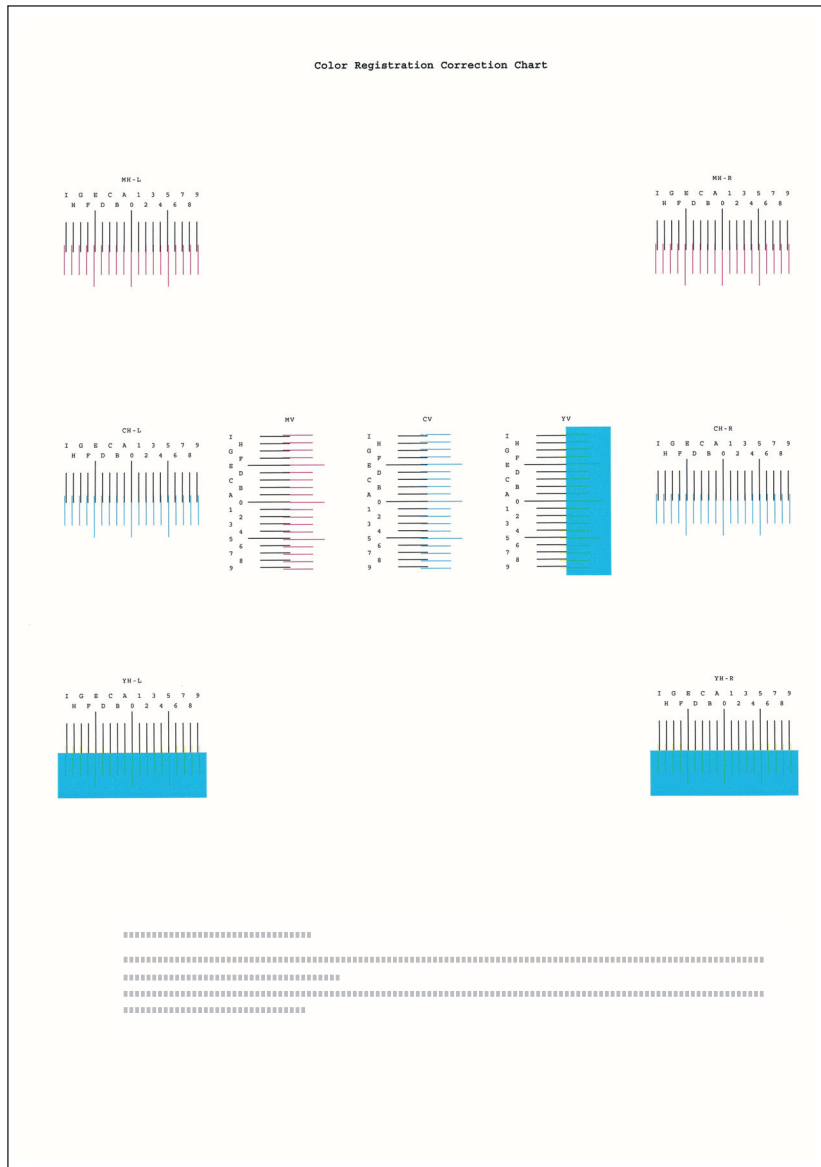

3 Display the correction menu

[▲] [▼] key > [Adjust Magenta] > [OK] key

The magenta correction menu appears.

4 Enter the appropriate value.

- 1 Find the location on each chart where 2 lines most closely match. If this is the 0 position, registration for that color is not required. For the illustration, B is the appropriate value.

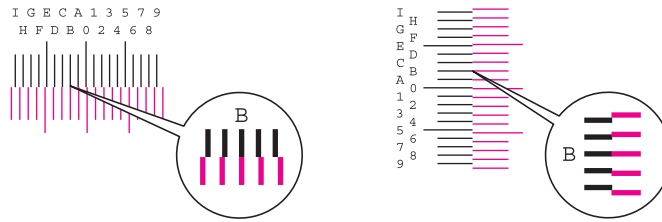

- 2 Select the [◀] or [▶] key to change the H-L, V, and H-R items, select the [▲] or [▼] key to enter the values read from the chart, and select the [OK] key.

Magenta correction is performed. After a brief interval, you will return to the standard menu for color printing position correction.

To increase the value from 0 up to a maximum of 9, select the [▲] key. To decrease the value, select the [▼] key.

Select [▼] to change the value from 0 to an alphabetical letter. Continue selecting to change from A through I. To move in the opposite direction, select [▲].

You cannot use the numeric keys to enter these values.

- 3 Repeat steps 3 to 4 to correct cyan and yellow.

Detailed Settings

1 Display the screen.

[Menu] key > [▲] [▼] key > [Adjust/Maint.] > [OK] key > [▲] [▼] key > [Color Regist.] > [OK] key > [▲] [▼] key > [Detail] > [OK] key

2 Print the chart.

[▲] [▼] key > [Print Chart] > [OK] key > [Yes]

A chart is printed. On the chart, for each of M (magenta), C (cyan) and Y (yellow), charts for H-1 to 5 and V-1 to 5 are printed.

After printing, you will return to the advanced menu for color printing position correction.

Chart Example

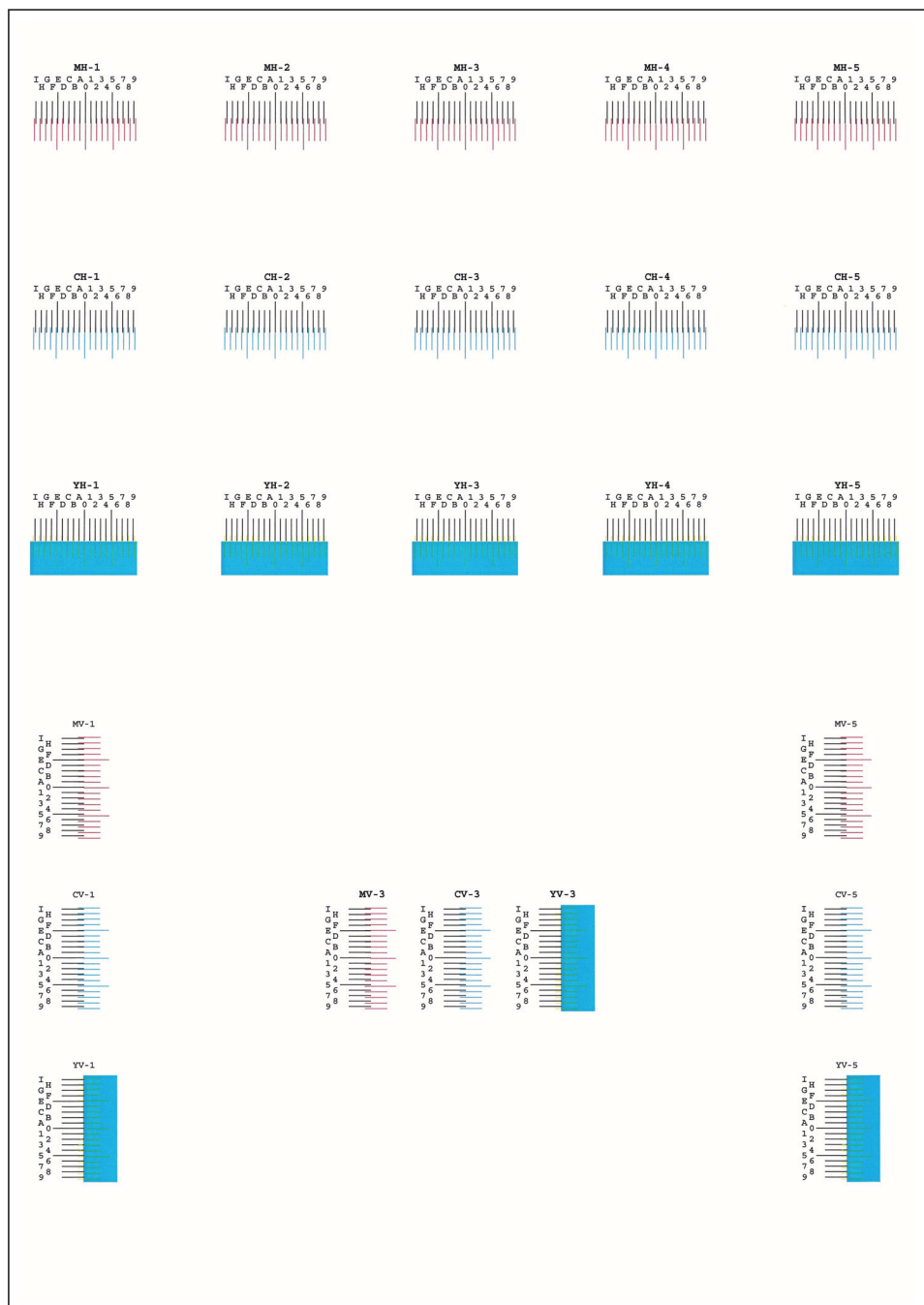

3 Display the correction menu

[▲] [▼] key > [Adjust Magenta] > [OK] key

The magenta correction menu appears.

4 Enter the appropriate value.

- 1 Find the location on each chart where 2 lines most closely match. If this is the 0 position, registration for that color is not required. For the illustration, B is the appropriate value.

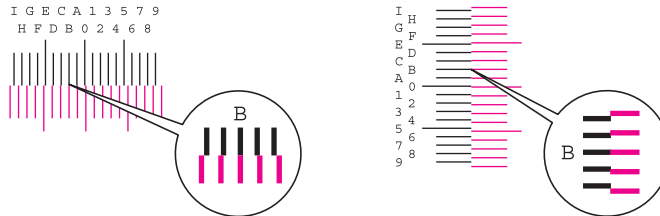

From charts H-1 to H-5, read the values from H-1 to H-5.

From charts V-1 to V-5, read only the values from V-3 (center).

- 2 Select the [◀] or [▶] key to change the H-1 to H-5 and V-3 items, select the [▲] or [▼] key to enter the values read from the chart, and select the [OK] key.

Magenta correction is performed. After a brief interval, you will return to the advanced menu for color printing position correction.

To increase the value from 0 up to a maximum of 9, select the [▲] key. To decrease the value, select the [▼] key.

Select [▼] to change the value from 0 to an alphabetical letter. Continue selecting to change from A through I. To move in the opposite direction, select [▲].

You cannot use the numeric keys to enter these values.

- 3 Repeat steps 3 to 4 to correct cyan and yellow.

Clearing Paper Jams

If a paper jam occurs, the message display will display "Paper Jam." and the machine will stop.

Refer to these procedures to remove the jammed paper.

Jam Location Indicators

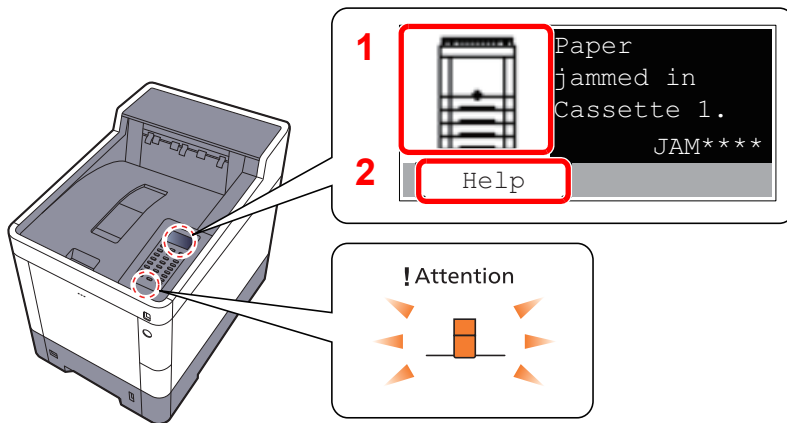

- 1 Shows the location of a paper jam.
- 2 Displays the Help screen.

NOTE

For details on Help Screen, refer to the following:

➔ [Help Screen \(page 2-12\)](#)

If a paper jam occurs, the location of the jam will be displayed on the message display as well as the clearing instructions.

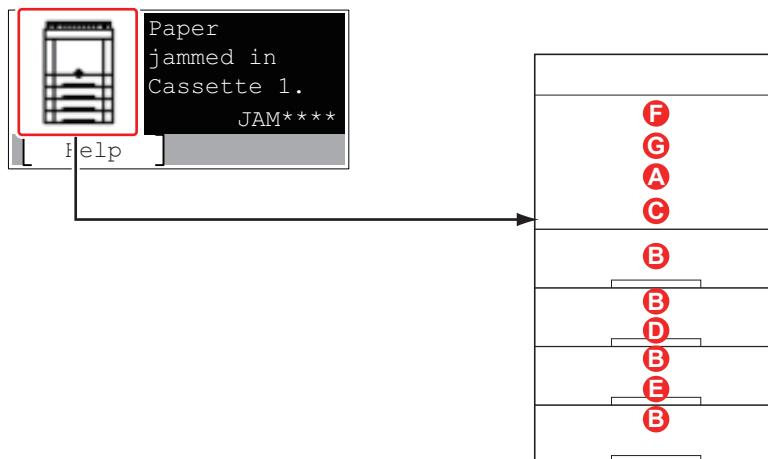

Paper Jam Location Indicator	Paper Jam Location	Reference Page
A	Multi Purpose Tray	page 10-26
B	Cassettes 1 to 4	page 10-28
C	Rear Cover 1 (Feed)	page 10-29
D	Rear Cover 2	page 10-30
E	Rear Cover 3	page 10-32
F	Rear Cover 1	page 10-33
G	Duplex Unit	page 10-35

After you remove the jam, the machine will warm up again and the error message will be cleared. The machine resumes with the page that was printing when the jam occurred.

Precautions with Paper Jams

- Do not reuse jammed papers.
- If the paper tears during removal, be sure to remove any loose scraps of paper from inside the machine. Scraps of paper left in the machine could cause subsequent jamming.



CAUTION

The fixing unit is extremely hot. Take sufficient care when working in this area, as there is a danger of getting burned.

Multi Purpose Tray

1

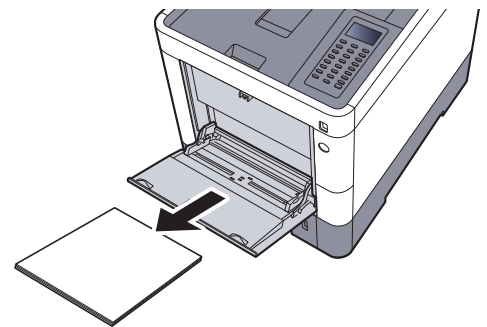
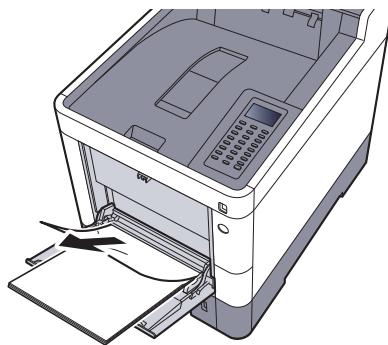

2

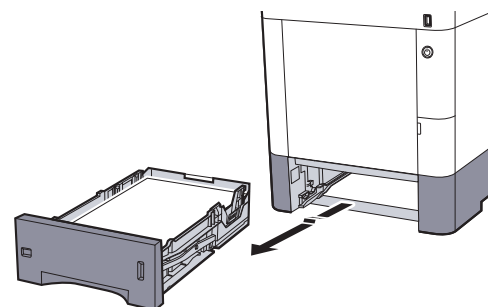
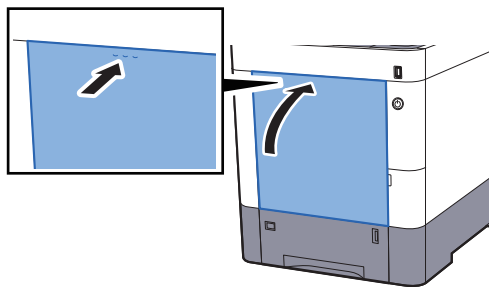

3

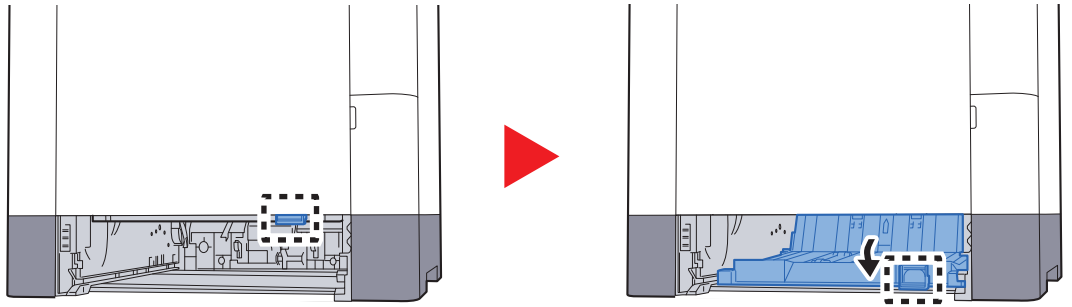

4

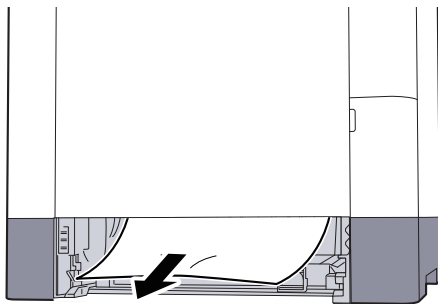

5

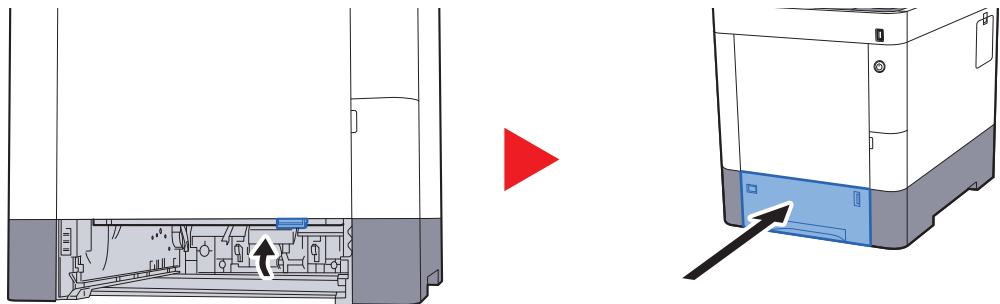

6

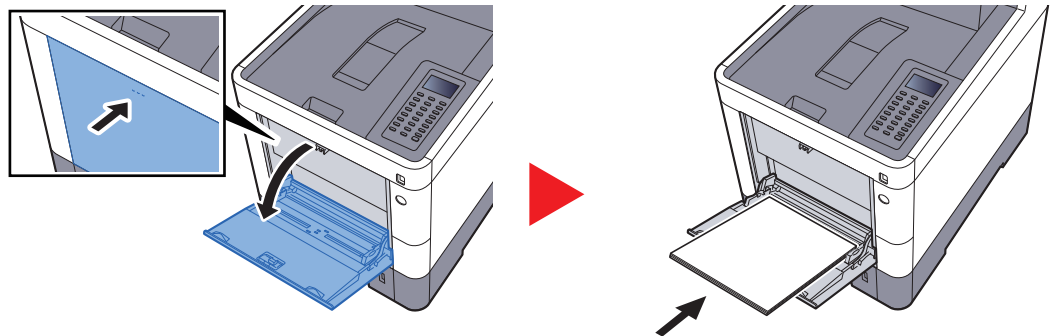

Cassettes 1 to 4

Procedures for handling a paper jam in Cassettes 1 to 4 are all the same. This section explains procedures using Cassette 1 as an example.

1

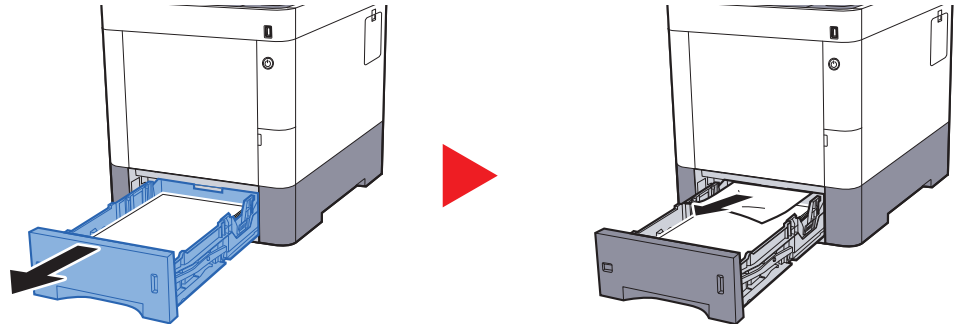

2

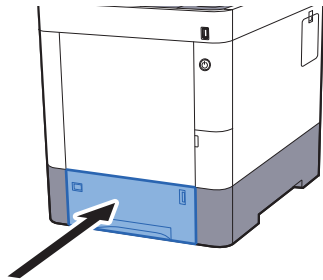

Rear Cover 1 (Feed)

1

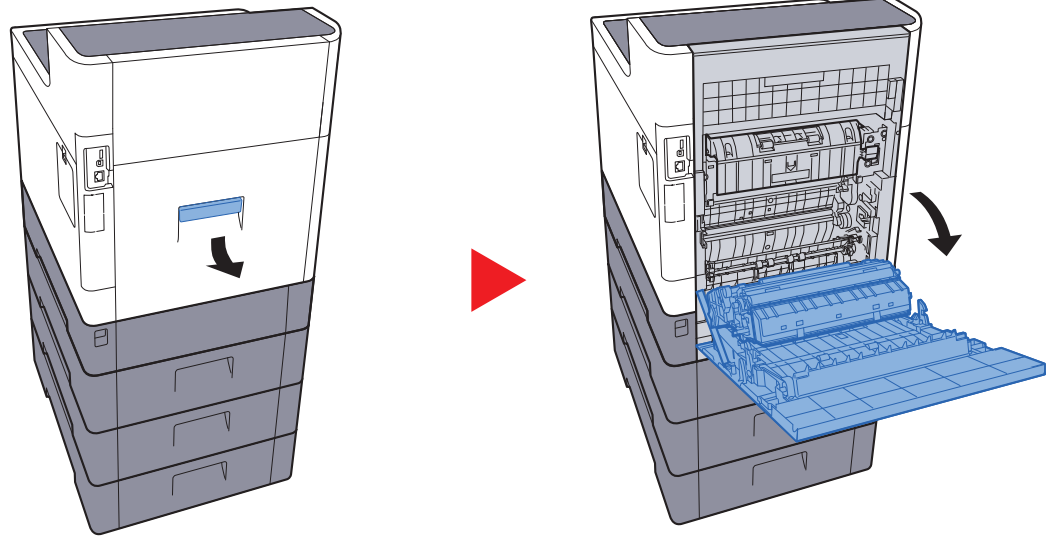

CAUTION

Some parts are very hot inside the machine. Exercise caution as there is a risk of burn injury.

2

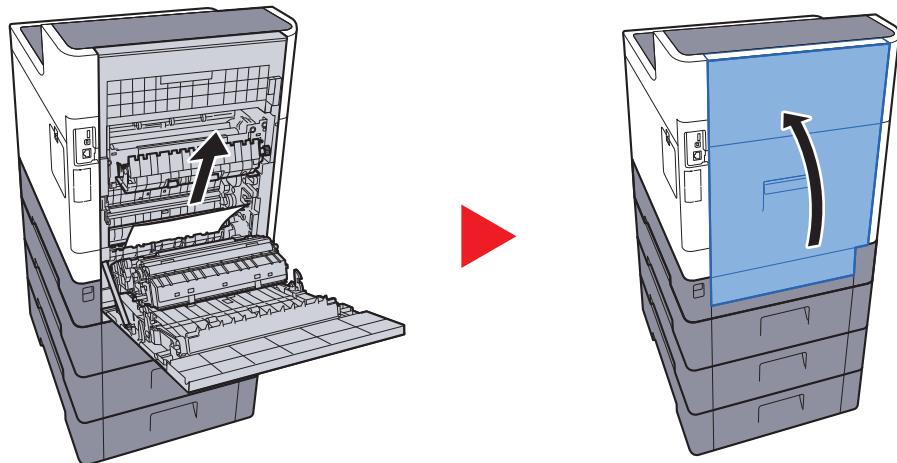

3

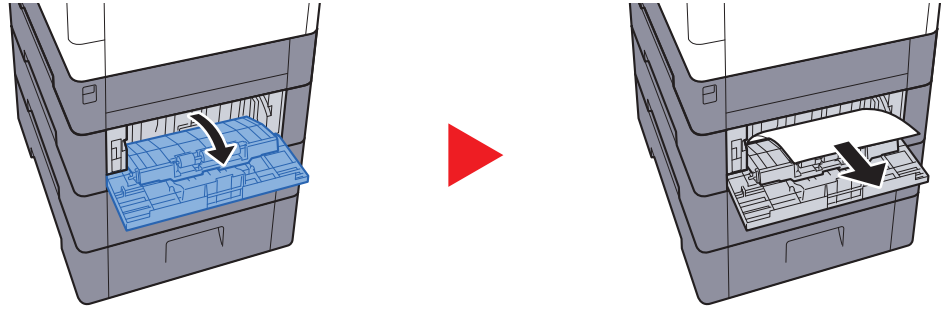

4

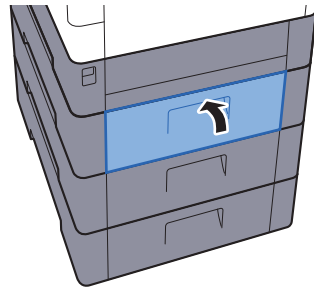

Rear Cover 2

1

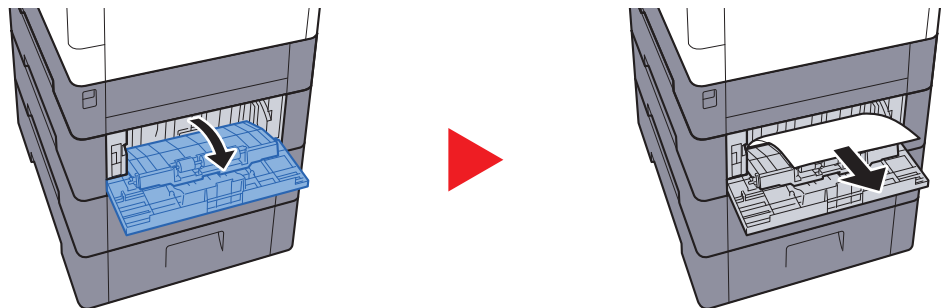

NOTE

If the paper cannot be removed, do not try to forcefully remove it.

➔ [Rear Cover 1 \(Feed\) \(page 10-29\)](#)

2

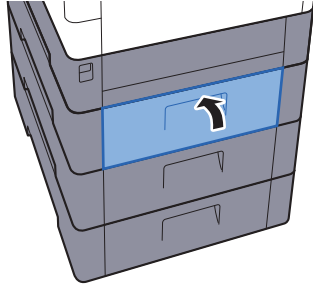

3

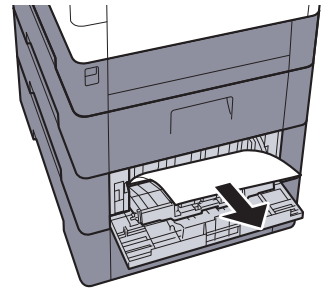
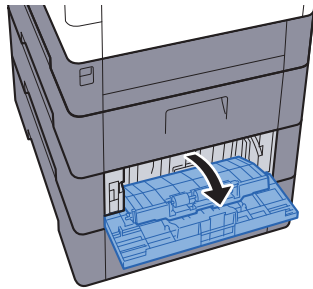

4

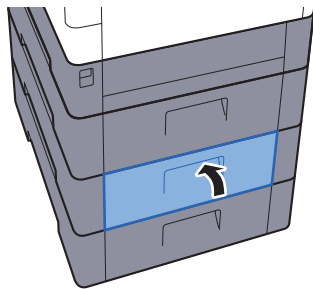

Rear Cover 3

1

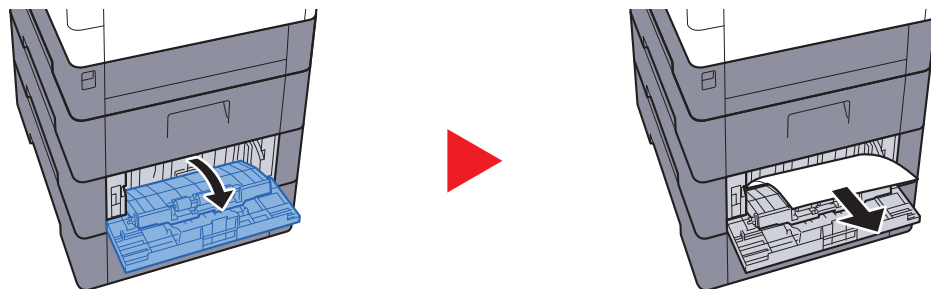

NOTE

If the paper cannot be removed, do not try to forcefully remove it.

➔ [Rear Cover 1 \(Feed\) \(page 10-29\)](#)

2

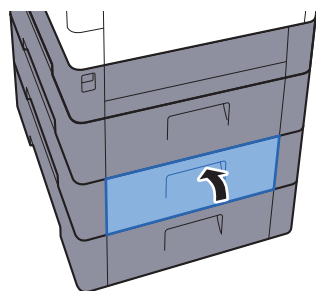

Rear Cover 1

1

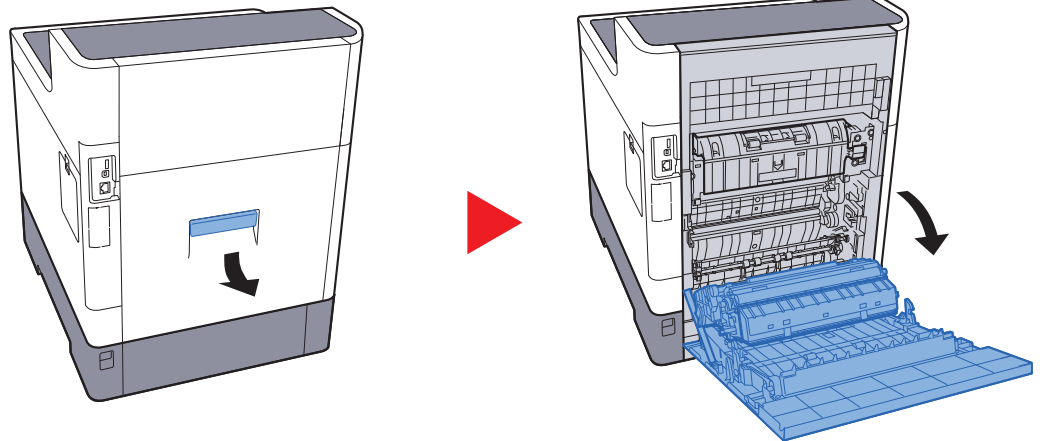

CAUTION

Some parts are very hot inside the machine. Exercise caution as there is a risk of burn injury.

2

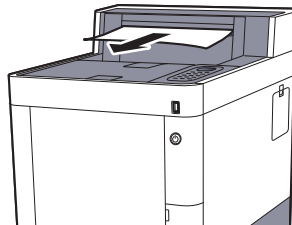

3

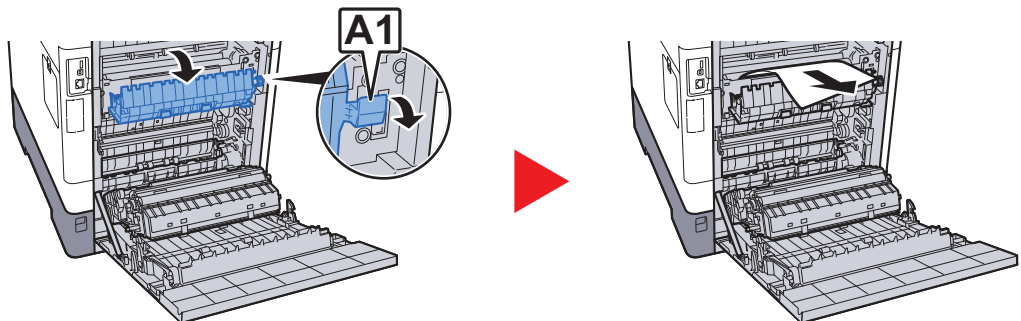

4

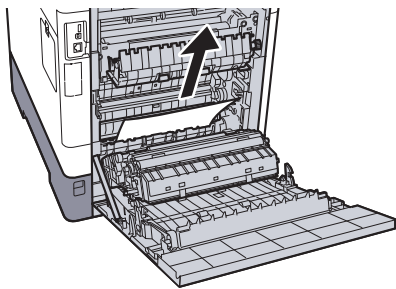

5

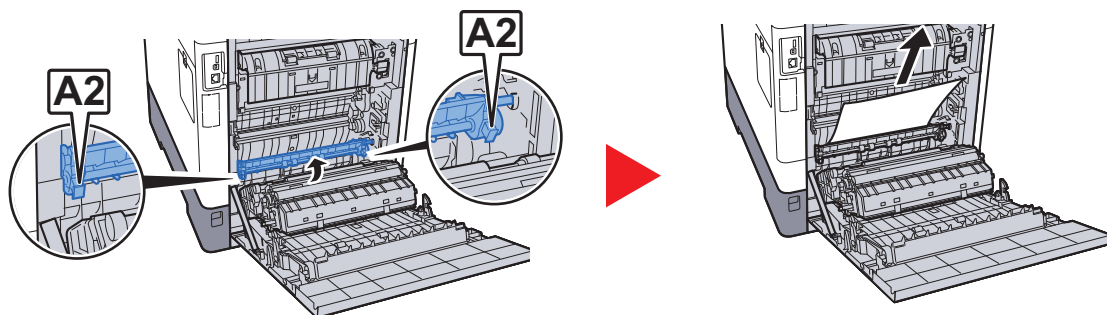

6

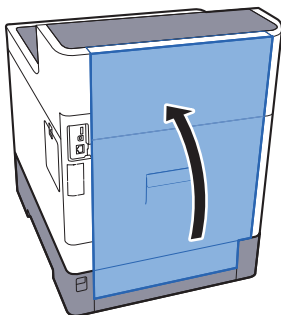

Duplex Unit

1

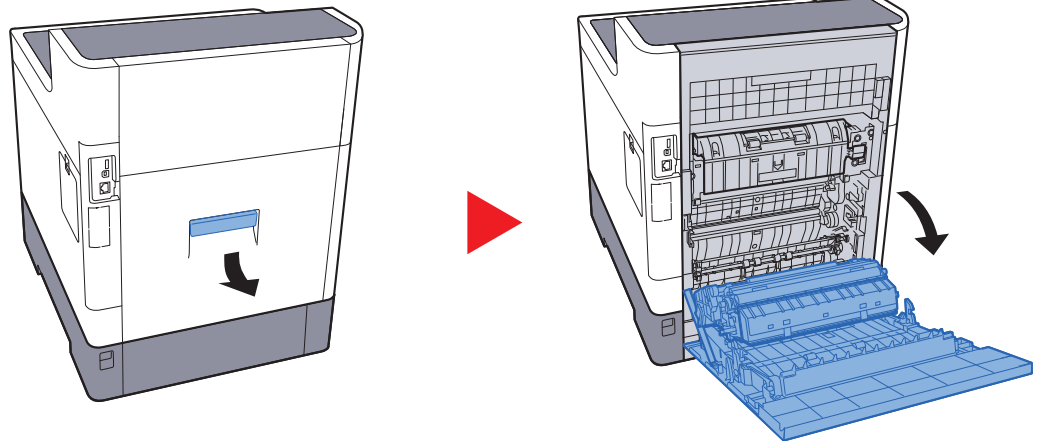

CAUTION

Some parts are very hot inside the machine. Exercise caution as there is a risk of burn injury.

2

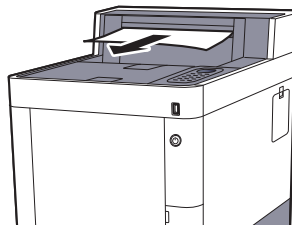

3

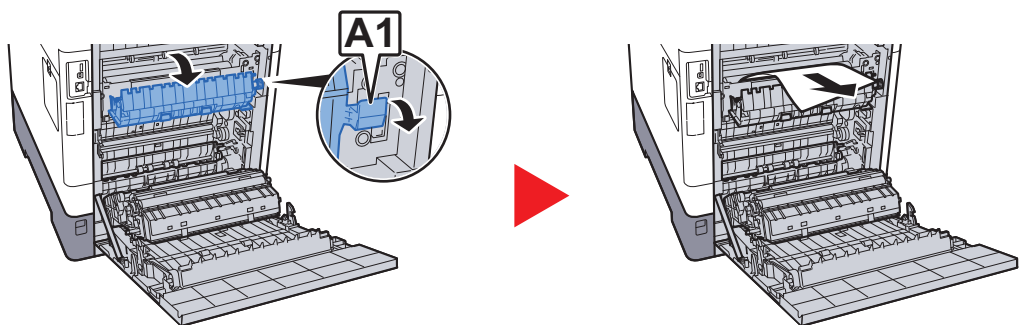

4

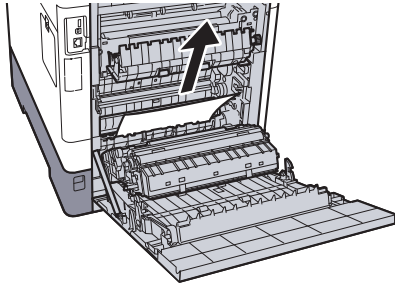

5

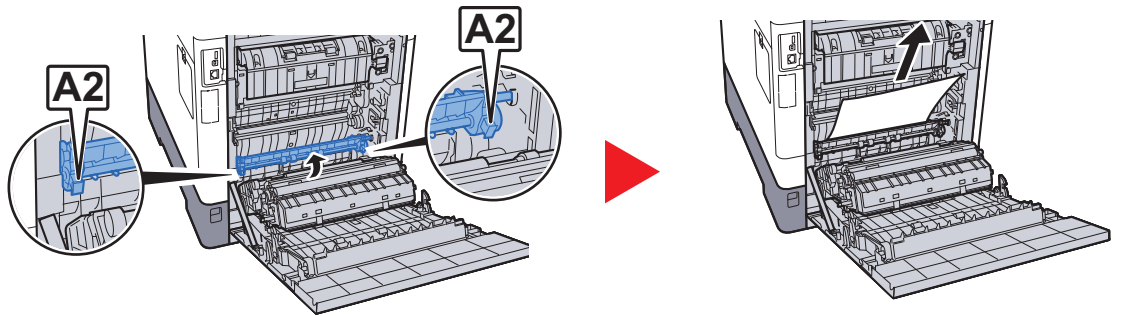

6

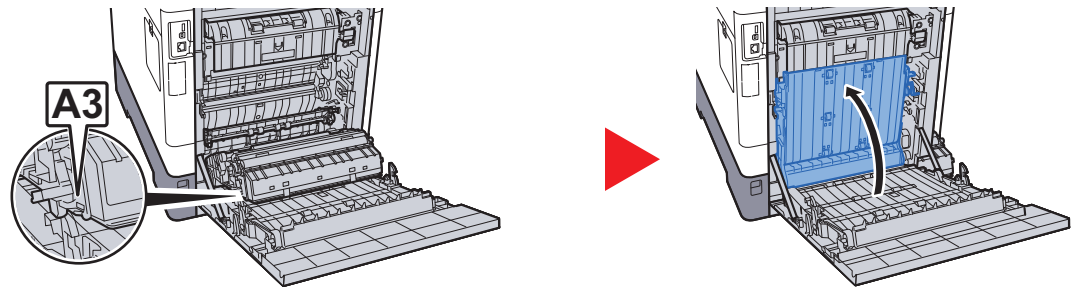

7

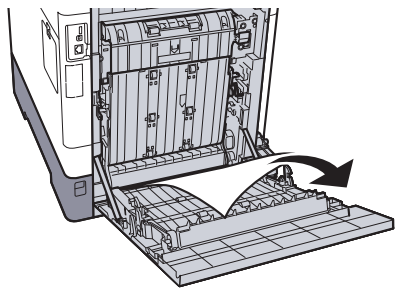

8

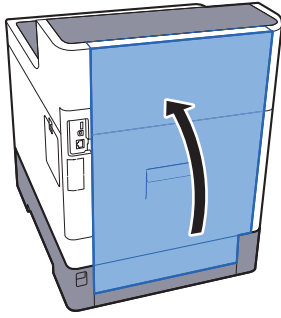

11 Appendix

This chapter explains the following topics:

Optional Equipment	11-2
Overview of Optional Equipment	11-2
Optional Applications	11-8
Character Entry Method	11-10
Using the Keys	11-10
Selecting Type of Characters	11-11
Characters That Can be Entered Using the Numeric Keys	11-11
Entering Symbols	11-12
Entering Characters	11-12
Paper	11-14
Basic Paper Specifications	11-14
Choosing the Appropriate Paper	11-15
Special Paper	11-18
Specifications	11-22
Machine	11-22
Printer Functions	11-24
Paper Feeder (500-sheet) (Option)	11-24
Glossary	11-25

Optional Equipment

Overview of Optional Equipment

The following optional equipment is available for the machine.

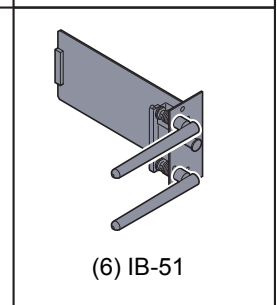
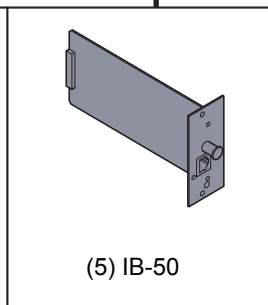
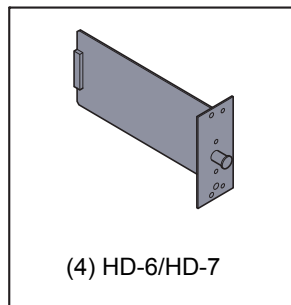
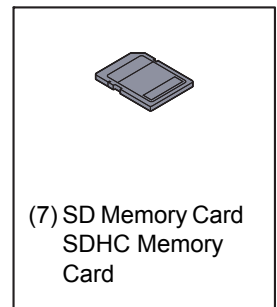
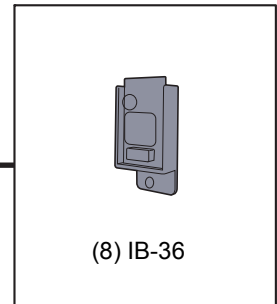
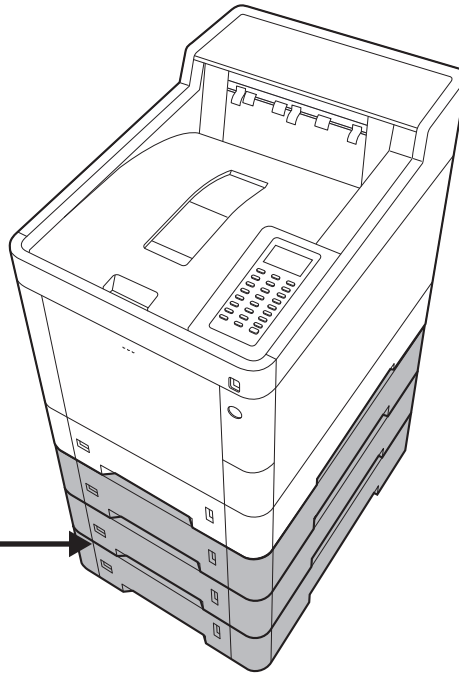
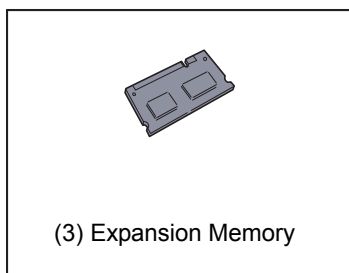
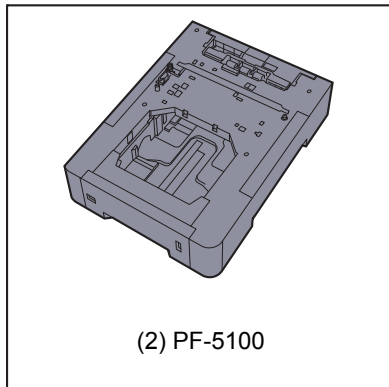
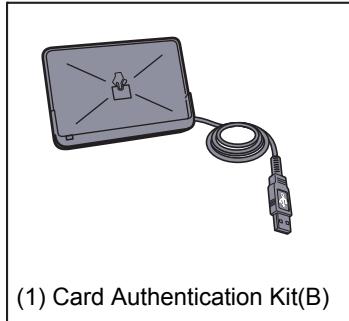

Software option
(9) Data Security kit(E)
(10) UG-33

(11) USB Keyboard

(1) Card Authentication Kit(B) "Card Authentication Kit"

User login administration can be performed using ID cards. To do so, it is necessary to register ID card information on the previously registered local user list. For more information about how to register this information, refer to the following:

➔ **Card Authentication Kit(B) Operation Guide**

(2) PF-5100 "Paper Feeder (500-sheet x1)"

Up to three additional cassettes identical to the machine's cassettes can be installed in the machine. Loading method are the same as the standard cassettes.

➔ [Loading in the Cassettes \(page 3-4\)](#)

(3) "Expansion Memory"

The machine can perform the more multiple jobs simultaneously by adding more memories. You can increase the machine's memory up to 3,072 MB by plugging in the optional memory modules.

Precautions for Handling the Memory Modules

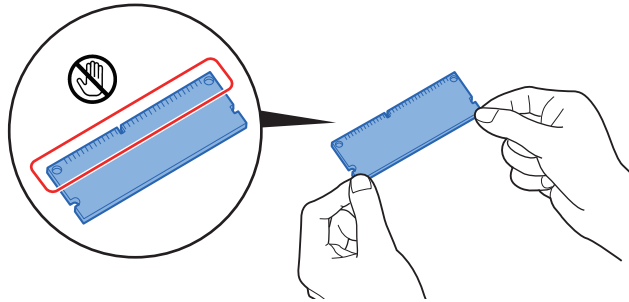

To protect electronic parts, discharge static electricity from your body by touching a water pipe (faucet) or other large metal object before handling the memory modules. Or, wear an antistatic wrist strap, if possible, when you install the memory modules.

Installing the Memory Modules

- 1 Turn off the machine and disconnect the power cord and interface cable.

 **NOTE**

If the optional IB-50/51 or HD-6/7 is installed, remove it.

- 2 Remove the covers.

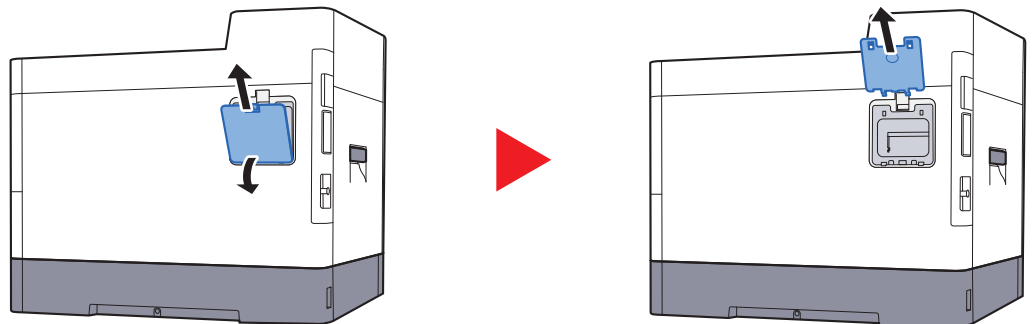

- 3 Remove the memory module from its package.
- 4 With the memory connection terminal pointing toward the socket, align the cut-out part with the socket terminal and insert directly in at an angle.

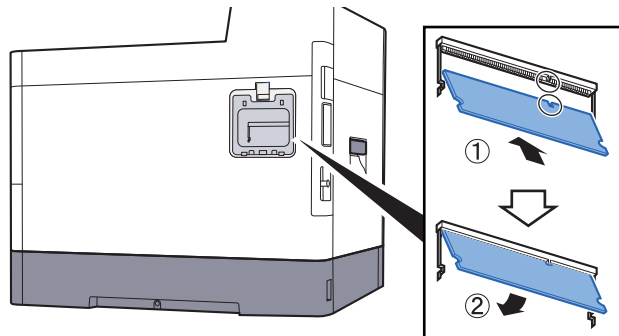

- 5 Carefully press the inserted memory down and into the machine.
- 6 Reinstall the covers.

Removing the Memory Module

To remove a memory module, remove the right cover and the memory slot cover from the machine. Then, carefully push out the two socket clamps. Ease the memory module out of the socket to remove.

Verifying the Expanded Memory

To verify that the memory module is working properly, test it by printing a status page.

➔ [Report \(page 8-5\)](#)

(4) HD-6/HD-7 "SSD"

With SSD installed in the machine, received data can be rasterized and stored on this SSD. This enables high-speed printing of multiple copies using an electric sort function. Also, you can use the Document Box functions.

➔ [What is Document Box? \(page 5-3\)](#)

(5) IB-50 "Network Interface Kit"

The Network Interface Kit provides a high-speed connection for the Gigabit-per-second interface. Settings are possible for a variety of OS and network protocols.

➔ **IB-50 User's Manual**

(6) IB-51 "Wireless Network Interface Kit"

This is a wireless LAN interface card which supports the wireless LAN specifications IEEE802.11n (Max 300 Mbps) and 11 g/b.

With the utilities supplied, settings are possible for a variety of OS and network protocols.

➔ **IB-51 User's Manual**

(7) "SD/SDHC Memory Card"

An SD/SDHC memory card is useful for storing fonts, macros, and overlays. The machine is equipped with a slot for an SDHC memory card with a maximum size of 32 GB, and an SD memory card with a maximum size of 2 GB.

Reading the SD/SDHC Memory Card

Once inserted in the machine's slot, the contents of the SD/SDHC memory card can be read from the operation panel or automatically when you power on or reset the machine.

Installing and Formatting the SD/SDHC Memory Card

To use an unused SD/SDHC memory card, you must first use the machine to format the SD/SDHC memory card.

- 1 Turn off the machine and disconnect the power cord and interface cable.
- 2 Remove the cover.

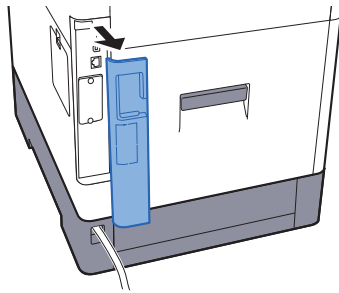

- 3 Remove the cover.

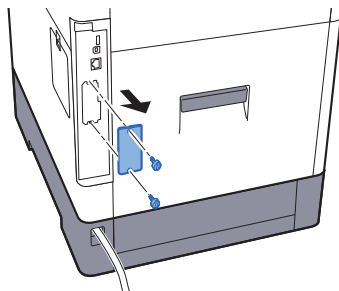

- 4 Insert the SD/SDHC memory card into the SD/SDHC memory card slot.

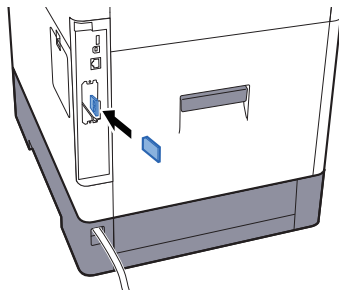

- 5 Replace the covers and close the rear cover.

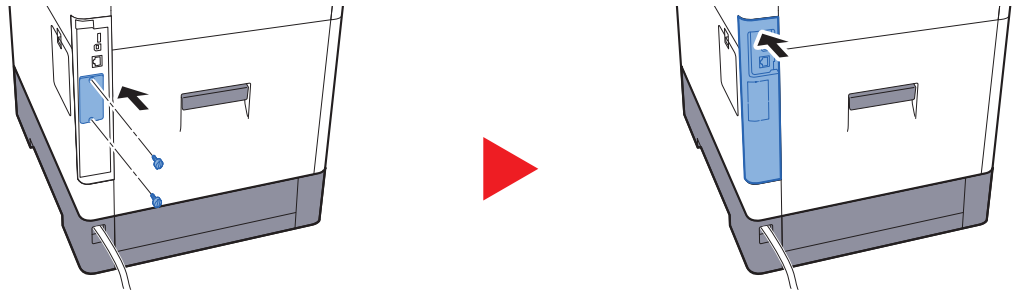

- 6 Insert the power cord into the socket and turn on the power switch.

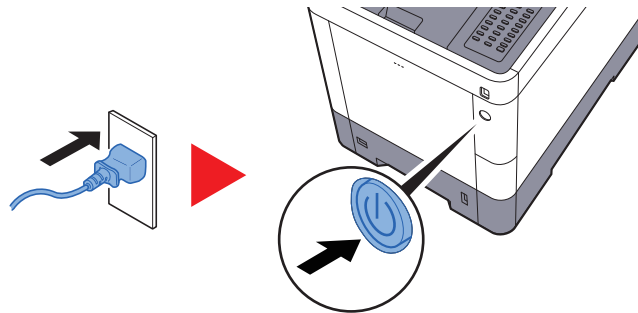

- 7 Format the SD/SDHC memory card from the operation panel.

For the procedure for formatting, refer to the following:

➔ [Format SD Card \(page 8-27\)](#)

(8) Wireless Network Interface Kit (IB-36)

This is a wireless LAN Interface card which supports the wireless LAN specifications IEEE802.11n (Max 65 Mbps) and 11 g/b. In addition, network printing is possible without using the wireless LAN router because Wi-Fi Direct is supported.

(9) Data Security Kit(E) "Data Security Kit"

The Data Security Kit overwrites all unnecessary data in the storage area so that it cannot be retrieved. The Data Security Kit encrypts data before storing it in the SSD. It guarantees higher security because no data cannot be decoded by ordinary output or operations.

(10) UG-33 "ThinPrint Option"

This application allows print data to be printed directly without a print driver.

(11) USB Keyboard "USB Keyboard"

A USB keyboard can be used to enter information into the text fields on the operation panel. A special mount is also available to install the keyboard on the machine. Please contact your dealer or service representative for information on keyboards that are compatible with your machine before you purchase one.

Optional Applications

Overview of the Applications

The applications listed below are installed on this machine.

Application
Data Security Kit
Card Authentication Kit* ¹
ThinPrint Option* ¹

*¹ This can be used on a trial basis for a limited time.

NOTE

- Restrictions such as the number of times the application can be used during the trial period differ depending on the application.
- If you change the date/time while using the trial version of an application, you will no longer be able to use the application.

Starting Application Use

Use the procedure below to start using an application.

- 1 **[Menu]** > **[▲]** **[▼]** key > **[Op Functions]** > **[OK]** key

NOTE

If the login user name entry screen appears during operations, enter a login user name and password, and select **[Login]**. For this, you need to login with administrator privileges.

The factory default login user name and login password are set as shown below.

	P-C3562DN	P-C4072DN
Login User Name:	3500	4000
Login Password:	3500	4000

- 2 Select the desired application, and select the **[OK]** key.
- 3 **[▲]** **[▼]** key > **[License On]** > **[OK]** key

NOTE

You can view detailed information on the selected application by selecting **[Detail]**.

- 4 **[▲]** **[▼]** key > **[Official]** > **[OK]** key

To use the application as a trial, select **[Trial]** without entering the license key.

- 5 Enter the license key > **[OK]** key

Some applications do not require you to enter a license key. If the license key entry screen does not appear, go to Step 6.

- 6 Select **[Yes]**.

**NOTE**

If you started the Security Kit or Thin Print option and entered the license key, turn the power OFF/ON.

Checking Details of Application

Use the procedure below to check the details of application.

- 1 **[Menu]** > **[▲]** **[▼]** key > **[Op Functions]** > **[OK]** key

**NOTE**

If the login user name entry screen appears during operations, enter a login user name and password, and select **[Login]**. For this, you need to login with administrator privileges.

The factory default login user name and login password are set as shown below.

	P-C3562DN	P-C4072DN
Login User Name:	3500	4000
Login Password:	3500	4000

- 2 Select the desired application, and select the **[OK]** key.

- 3 **[▲]** **[▼]** key > **[Detail]** > **[OK]** key

You can view detailed information on the selected application. Select the **[▶]** key to view the next screen. Select the **[◀]** key to return to the previous screen.

The table below lists the item you can view.

Item
Function Name
License On
Trial Counts
Date of Trial
Status

Extend the trial period.

[◀] **[▶]** key > **[Date of Trial]** > **[Extend]** > **[Yes]**

The trial period is extended.

Character Entry Method

Using the Keys

Use the following keys to enter characters.

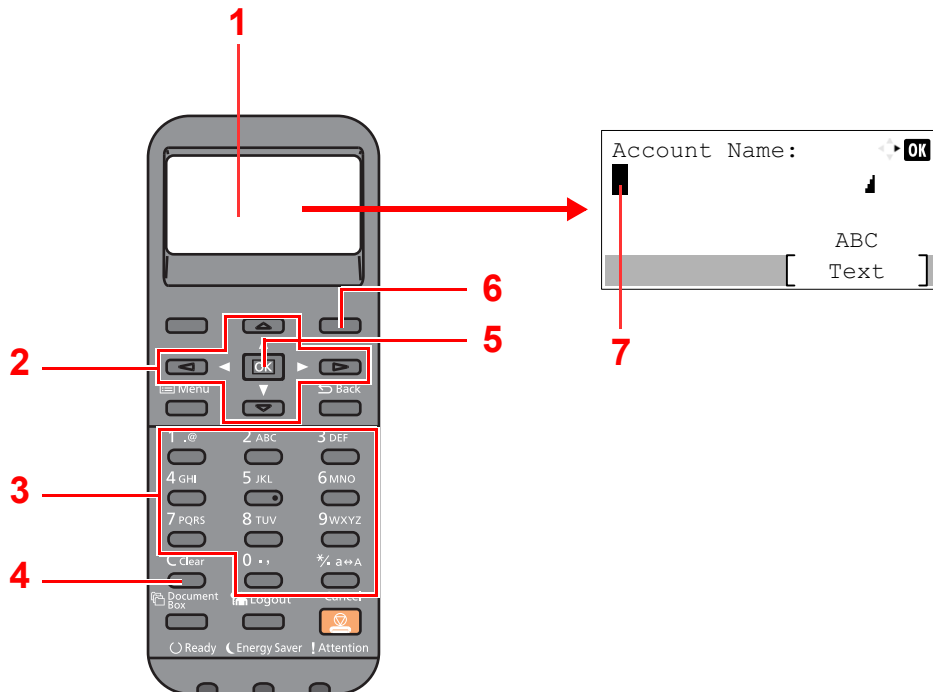

No.	Display/Key	Description
1	Message Display	Displays entered characters.
2	Arrow keys	Select to select the entry position, or select a character from the character list.
3	Numeric keys	Select to enter characters and symbols.
4	[Clear] key	Select to delete characters.
5	[OK] key	Select to finalize entry and return to the screen before the entry. To enter a symbol, select to confirm the selected symbol.
6	Right Select key	Select to select the type of characters you want to enter. (When [Text] is displayed)
7	Cursor	Characters are entered at the position of the cursor.

Selecting Type of Characters

To enter characters, the following three types are available:

Types	Description
ABC	To enter alphabets.
123	To enter numerals.
Symbols	To enter symbols.

In a character entry screen, select **[Text]** to select the type of characters you want to enter.

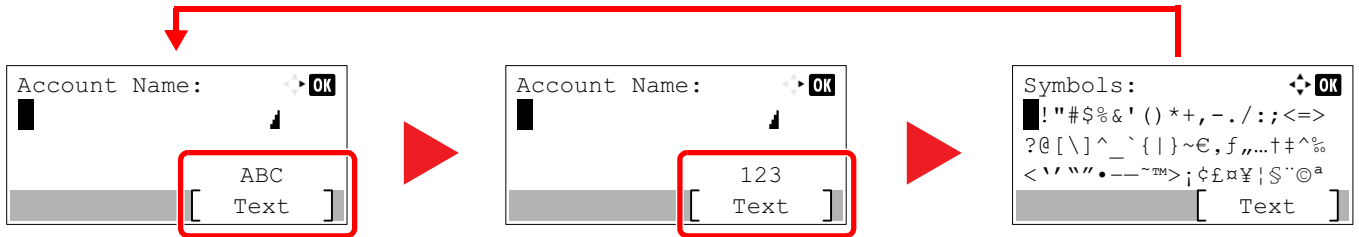

Each time you select **[Text]**, the character type switches as follows: **[ABC]**, **[123]**, **[Symbols]**, **[ABC]** ...

Characters That Can be Entered Using the Numeric Keys

The following table lists the characters that can be entered using the numeric keys.

Keys	Characters (Each press of a key changes the character in the order from left to right.)
1 .@ 	. @ - _ / : ~ 1 (Repeats from the first character on the left) 1 (During number entry)
2 ABC 	a b c A B C 2 (Repeats from the first character on the left) 2 (During number entry)
3 DEF 	d e f D E F 3 (Repeats from the first character on the left) 3 (During number entry)
4 GHI 	g h i G H I 4 (Repeats from the first character on the left) 4 (During number entry)
5 JKL 	j k l J K L 5 (Repeats from the first character on the left) 5 (During number entry)
6 MNO 	m n o M N O 6 (Repeats from the first character on the left) 6 (During number entry)
7 PQRS 	p q r s P Q R S 7 (Repeats from the first character on the left) 7 (During number entry)
8 TUV 	t u v T U V 8 (Repeats from the first character on the left) 8 (During number entry)

- 3 Select the [▶] key. The cursor moves to the right.

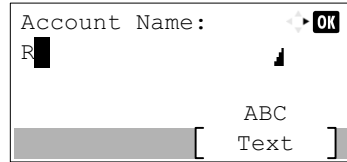

- 4 Select the [#] key. Displays the symbol list.

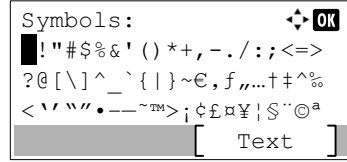

- 5 Select the [▲] or [▼] key to move the cursor and select [&].

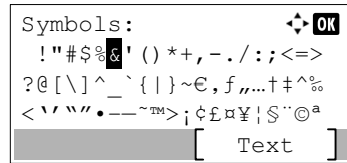

- 6 Select the [OK] key. [&] is entered.

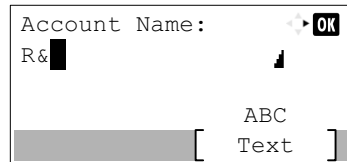

- 7 Select the [3] key four times. [D] is entered.

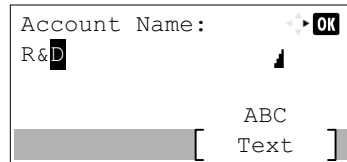

- 8 Select the [▶] key.

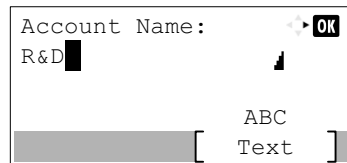

Paper

This section explains the paper sizes and types that can be used in the paper source.

For details on the sizes, types, and number of sheets of paper that can be loaded in each paper tray, refer to the following:

➔ [Specifications \(page 11-22\)](#)

Basic Paper Specifications

This machine is designed to print on standard copy paper as used in regular ('dry') copiers and page printers such as laser printers. It also supports a variety of other types of paper that conform to the specifications given in this appendix.

Be careful when choosing paper. Paper unsuitable for the machine may cause jams or may be wrinkled.

Supported Paper

Use standard copy paper for regular copiers or laser printers. The printing quality will be affected by the quality of paper. Poor quality paper may result in unsatisfactory output.

Basic Paper Specifications

The following table lists the specifications of paper that is supported with this machine. Refer to the subsequent sections for further details.

Criteria	Specifications
Weight	Cassettes: 60 to 163 g/m ²
	Multi purpose tray: 60 to 220 g/m ²
Dimensional accuracy	±0.7 mm
Squareness of corners	90° ±0.2°
Moisture content	4 to 6%
Pulp content	80% or more



NOTE

Some recycled paper does not meet requirements for use with this machine as listed in the Basic Paper Specifications shown below, such as moisture or pulp content. For this reason, we recommend purchasing a small amount of recycled paper as a sample for testing prior to use. Choose recycled paper that gives the best printing results and contains low levels of paper dust.

We are not responsible for the problems occurred from the use of paper that does not conform to our specifications.

Choosing the Appropriate Paper

This section describes guidelines for choosing paper.

Condition

Avoid using paper with bent corners or that is curled, dirty, or torn. Do not use paper that has a rough surface or paper fiber lint, or that is especially delicate. Use of paper in any of these conditions will not only deliver poor copies but may also cause jams and shorten the useful life of the machine. Choose paper with a smooth and even surface; however, avoid coated paper or paper with a treated surface as it may damage the drum or fusing unit.

Ingredients

Do not use paper such as paper that has been coated or surface-treated or paper that contains plastic or carbon. Those types of paper may produce harmful fumes from the heat of printing and may damage the drum.

Be sure to use the standard paper that contains at least 80% pulp, i.e., not more than 20% of the total paper content consists of cotton or other fibers.

Supported Paper Sizes

Paper of the following sizes is supported by the machine.

Measurements in the table take into account a ± 0.7 mm dimensional accuracy for length and width. Corner angles must be $90^\circ \pm 0.2^\circ$.

Paper Size	Cassette 1	Cassettes 2 to 4	Multi Purpose Tray
Envelope Monarch (3-7/8 × 7-1/2")	×	○	○
Envelope #10 (4-1/8 × 9-1/2")	×	○	○
Envelope DL (110 × 220 mm)	×	○	○
Envelope C5 (162 × 229 mm)	×	○	○
Executive (7-1/4 × 10-1/2")	○	○	○
Letter	○	○	○
Legal	○	○	○
A4 (297 × 210 mm)	○	○	○
B5 (257 × 182 mm)	○	○	○
A5 (210 × 148 mm)	○	○	○
A6 (148 × 105 mm)	○	×	○
B6 (182 × 128 mm)	○	○	○
Envelope #9 (3-7/8 × 8-7/8")	×	○	○
Envelope #6 (3-5/8 × 6-1/2")	×	○	○
ISO B5 (176 × 250 mm)	○	○	○
Hagaki (Cardstock) (100 × 148 mm)	×	×	○
Oufuku hagaki (Return postcard) (148 × 200 mm)	×	×	○
Oficio II	○	○	○
216 × 340 mm	○	○	○
16K (273 × 197 mm)	○	○	○

Paper Size	Cassette 1	Cassettes 2 to 4	Multi Purpose Tray
Statement	○	○	○
Folio (210 × 330 mm)	○	○	○
Youkei 4 (105 × 235 mm)	×	○	○
Youkei 2 (114 × 162 mm)	×	○	○
Custom	Cassette 1: 105 × 148 to 216 × 356 mm Cassettes 2 to 4: 92 × 162 to 216 × 356 mm Multi Purpose Tray: 70 × 148 to 216 × 356 mm		

Smoothness

The paper surface should be smooth, but it must be uncoated. With paper that is too smooth and slippery, several sheets may accidentally be supplied at once, causing jams.

Basis Weight

In countries that use the metric system, basis weight is the weight in grams of one sheet of paper one square meter in area. In the United States, basis weight is the weight in pounds of one ream (500 sheets) of paper cut to the standard size (or trade size) for a specific grade of paper. Paper that is too heavy or too light may be supplied incorrectly or cause paper jams, which may cause excessive wear of the machine. Mixed paper weight (i.e., thickness) may cause several sheets to be supplied at once accidentally and may also cause blurring or other printing problems if the toner fails to adhere correctly.

Moisture Content

Paper moisture content is the ratio of moisture to dryness expressed as a percentage. Moisture affects how the paper is supplied, the electrostatic chargeability of the paper, and how the toner adheres.

Paper moisture content varies depending on the relative humidity in the room. High relative humidity causes paper to become damp, making the edges expand so it appears wavy. Low relative humidity causes paper to lose moisture, making the edges tighten and weakening print contrast.

Wavy or tight edges may cause the paper to slip when it is supplied. Try to keep the moisture content between 4 to 6%.

To maintain the right level of moisture content, bear in mind the following considerations.

- Store paper in a cool, well-ventilated place.
- Store paper flat and unopened in the package. Once the package is opened, reseal it if the paper is not to be used for a while.
- Store paper sealed in the original package and box. Put a pallet under the carton to keep it raised above the floor. Especially during rainy seasons keep the paper a sufficient distance away from wooden or concrete floors.
- Before using paper that has been stored, keep it at the proper moisture level for at least 48 hours.
- Do not store paper where it is exposed to heat, sunlight, or dampness.

Other Paper Specifications

Porosity: The density of the paper fibers.

Stiffness: Paper must be stiff enough or it may buckle in the machine, causing jams.

Curl: Most paper naturally tends to curl after the package is opened. When paper passes through the fixing unit, it curls upward slightly. To deliver flat printouts, load the paper so that the curl faces towards the bottom of the paper tray.

Static electricity: During printing, paper is electrostatically charged so that the toner adheres. Choose paper that can be discharged quickly so that copies do not cling together.

Whiteness: Paper whiteness affects print contrast. Use whiter paper for sharper, brighter copies.

Quality: Machine problems may occur if sheet sizes are not uniform or if corners are not square, edges are rough, sheets are uncut, or edges or corners are crushed. In order to prevent these problems, be especially careful when you cut the paper yourself.

Packaging: Choose paper that is properly packaged and stacked in boxes. Ideally, the packaging itself should have been treated with a coating to inhibit moisture.

Specially treated paper: We do not recommend printing onto the following types of paper, even if it conforms to the basic specifications. When you use these kinds of paper, purchase a small amount first as a sample to test.

- Glossy paper
- Watermarked paper
- Paper with an uneven surface
- Perforated paper

Special Paper

This section describes printing onto special paper and print media.

The following paper and media can be used.

- Transparencies
- Preprinted paper
- Bond paper
- Recycled paper
- Thin paper
- Letterhead
- Colored paper
- Prepunched paper
- Envelopes
- Hagaki (Cardstock)
- Thick paper
- Labels
- Coated
- High-quality paper

When using these paper and media, choose those that are designed specifically for copiers or page printers (such as laser printers). Use the multi purpose tray for transparencies, thick paper, envelopes, cardstocks, and label paper.

Choosing Special Paper

Although special paper that meets the following requirements can be used with the machine, print quality will vary considerably due to differences in the construction and quality of special paper. Thus, special paper is more likely than regular paper to cause printing problems. Before purchasing special paper in volume, try testing a sample to ensure the print quality is satisfactory. General precautions when printing onto special paper are given below. Note that we are not responsible for any harm to the user or damage to the machine caused by moisture or specifications of special paper.

Select a cassette or multi purpose tray for special paper.

Transparencies

Transparencies must be able to withstand the heat of printing. Transparencies must meet the following conditions.

Heat resistance	Must withstand at least 190°C
Thickness	0.100 to 0.110 mm
Material	Polyester
Dimensional accuracy	±0.7 mm
Squareness of corners	90° ±0.2°

To avoid problems, use the multi purpose tray for transparencies and load transparencies with the long side facing the machine.

If transparencies jam frequently at output, try pulling the leading edge of sheets gently as they are ejected.

Label

Be sure to feed labels from the multi purpose tray.

For selecting labels, use extreme care so that the adhesive may not come in direct contact with any part of the machine and that the labels are not easily peeled from the carrier sheet. Adhesives that stick to the drum or rollers and peeled labels remaining in the machine may cause a failure.

When printing onto labels, you must be liable for the print quality and possible trouble.

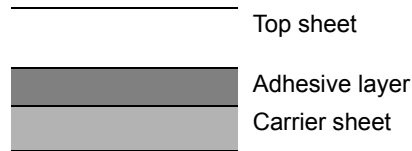

Labels consist of three layers as shown in the illustration. The adhesive layer contains materials that are easily affected by the force applied in the machine. The carrier sheet bears the top sheet until the label is used. This composition of labels may cause more problems.

The label surface must be covered completely with the top sheet. Gaps between labels may cause peeling of labels, resulting in a serious failure.

Some label paper has large margins on the top sheet. When using such paper, do not peel these margins from the carrier sheet before completing output.

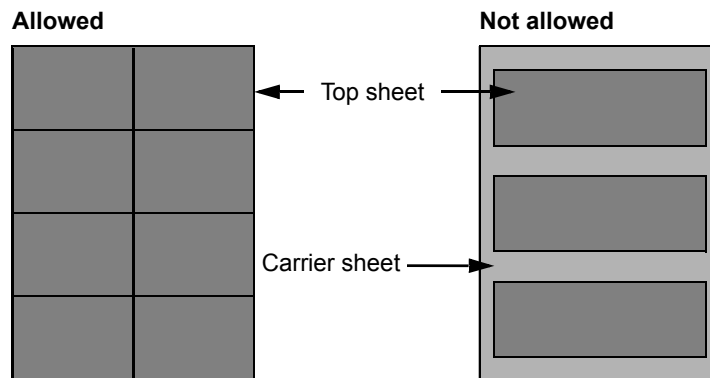

Use label paper that conforms to the following specifications.

Top sheet weight	44 to 74 g/m ²
Basis weight (overall paper weight)	104 to 151 g/m ²
Top sheet thickness	0.086 to 0.107 mm
Overall paper thickness	0.115 to 0.145 mm
Moisture content	4 to 6 % (composite)

Hagaki (Cardstock)

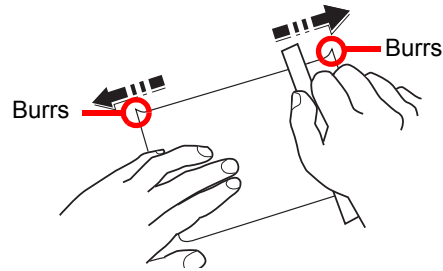

Before loading Hagaki (Cardstock) into the multi purpose tray, fan them and align the edges. If the Hagaki (Cardstock) paper is curled, straighten it before loading. Printing onto curled Hagaki (Cardstock) may cause jams.

Use unfolded Oufuku hagaki (Return postcard) (available at post offices). Some Hagaki (Cardstock) may still have rough edges developed by a paper cutter on the back side. Remove any such rough edges by placing the Hagaki (Cardstock) on a flat surface and rubbing the edges gently a few times with a ruler.

Envelopes

Envelopes should be fed from the MP tray with the print-side up or the optional paper feeder with the print-side up.



NOTE

Do not load paper above the load limits located on the paper width guide of the optional paper feeder.

Due to the structure of envelopes, printing evenly over the entire surface may not be possible in some cases. Thin envelopes in particular may be wrinkled by the machine in some cases as they pass through. Before purchasing envelopes in volume, try testing a sample to ensure the print quality.

Storing envelopes for a long period may cause them to become wrinkled. Thus, keep the package sealed until you are ready to use them.

Keep the following points in mind.

- Do not use envelopes with exposed adhesive. In addition, do not use the type of envelope in which the adhesive is exposed after the top layer is peeled off. Serious damage may be caused if the paper covering the adhesive comes off in the machine.
- Do not use envelopes with certain special features. For example, do not use envelopes with a grommet for winding a string to close the flap or envelopes with an open or film-covered window.
- If paper jams occur, load fewer envelopes at once.

Thick Paper

Before loading thick paper in the multi purpose tray, fan it and align the edges. Some thick paper may still have rough edges developed by a paper cutter on the back side. Remove any such rough edges just as with Hagaki (Cardstock) by placing the paper on a flat surface and rubbing the edges gently a few times with a ruler. Printing onto paper with rough edges may cause jams.



NOTE

If the paper is not supplied correctly even after it is smoothed, load the paper in the multi purpose tray with the leading edge raised a few millimeters.

Colored Paper

Colored paper must conform to the specifications.

➔ [Basic Paper Specifications \(page 11-14\)](#)

In addition, the pigments in the paper must be able to withstand the heat of printing (up to 200°C or 392°F).

Preprinted Paper

Preprinted paper must conform to the specifications.

➔ [Basic Paper Specifications \(page 11-14\)](#)

The colored ink must be able to withstand the heat of printing. It must be resistant to silicone oil as well. Do not use paper with a treated surface such as glossy paper used for calendars.

Recycled Paper

Recycled paper must conform to the specifications; however, its whiteness may be considered separately.

➔ [Basic Paper Specifications \(page 11-14\)](#)



NOTE

Before purchasing recycled paper in volume, try testing a sample to ensure satisfactory print quality.

Coated Paper

Coated paper is created by treating the surface of the base paper with a coating that provides higher printing quality than plain paper. Coated paper is used for particularly high quality printing.

The surface of high-quality or medium-quality paper is coated with special agents that improve ink adhesion by making the paper surface smoother. These agents are used either to coat both sides of the paper or just one side. The coated side appears slightly glossy.



IMPORTANT

When printing on coated paper in very humid environments, ensure that the paper is kept dry as moisture may cause sheets to stick together when they are fed into the machine. If printing in very humid environments, set coated paper for one sheet each.

Specifications

 **IMPORTANT**

Specifications are subject to change without notice.

Machine

Item		Description
Type		Desktop
Printing Method		Electrophotography by semiconductor laser
Paper Weight	Cassette	60 to 163 g/m ²
	Multi Purpose Tray	60 to 220 g/m ²
Paper Type	Cassette	Plain, Rough, Recycled, Vellum, Preprinted, Bond, Color (Colour), Prepunched, Letterhead, Thick, High Quality, Custom 1 to 8 (Duplex: Same as Simplex)
	Multi Purpose Tray	Plain, Transparency (OHP film), Rough, Vellum, Labels, Recycled, Preprinted, Bond, Cardstock, Coated, Color (Colour), Prepunched, Letterhead, Envelope, Thick, High Quality, Custom 1 to 8
Paper Size	Cassette	A4, A5, A6, B5, B6, Letter, Legal, Statement, Executive, Oficio II, Folio, 216 × 340 mm, 16K, B5 (ISO), Custom (105 × 148 mm to 216 × 356 mm)
	Multi Purpose Tray	A4, A5, A6, B5, B6, Folio, 216 × 340 mm, Letter, Legal, Statement, Executive, Oficio II, 16K, B5 (ISO), Envelope #10, Envelope #9, Envelope #6 3/4, Envelope Monarch, Envelope DL, Envelope C5, Hagaki (Cardstock), Oufuku Hagaki (Return postcard), Youkei 4, Youkei 2, Custom (70 × 148 mm to 216 × 356 mm)
Warm-up Time (22°C/71.6°F, 60%)	Power on	P-C3562DN: 25 seconds or less P-C4072DN: 24 seconds or less
	Sleep	P-C3562DN: 19 seconds or less P-C4072DN: 21 seconds or less
Paper Capacity	Cassette	500 sheets (80 g/m ²) *1
	Multi Purpose Tray	100 sheets (80 g/m ²)

*1 Up to upper limit height line in the cassette.

Item		Description
Output Tray Capacity	Top tray	500 sheets (80 g/m ²)
Image Write System		Semiconductor laser and electrophotography
Memory		1,024 MB
Interface	Standard	USB Interface Connector: 1 (Hi-Speed USB) Network interface: 1 (10 BASE-T/100 BASE-TX/1000 BASE-T) USB Port: 2 (Hi-Speed USB)
	Option	eKUIO: 1
Operating Environment	Temperature	10 to 32.5°C/50 to 90.5°F
	Humidity	10 to 80 %
	Altitude	3,500 m/11,482 ft maximum
	Brightness	1,500 lux maximum
Dimension (W × D × H)		15.36" × 20.95" × 18.49" 390 × 532 × 469.5 mm
Weight		P-C3562DN: Approx. 65.1 lb/Approx. 29.5 kg P-C4072DN: Approx. 68.4 lb/Approx. 31.0 kg (without toner container)
Space Required (W × D) (Using multi purpose tray)		15.36" × 28.58" 390 × 725.8 mm
Power Source		P-C3562DN: 230 V Specification Model: 220 to 240 V ~ 50/60 Hz 5.6 A P-C4072DN: 230 V Specification Model: 220 to 240 V ~ 50/60 Hz 5.8 A
The power consumption of the product in networked standby (If all network ports are connected.)		The information is available at the website below. http://www.triumph-adler.com/C125713A00471CCE/direct/environment http://www.triumph-adler.de/C125713A00471CCE/direct/umwelt http://www.utax.de/C12571260052E282/direct/umwelt-energieverbrauch-sicherheit http://www.utax.de/C12571260052E282/direct/environment
Options		➔ Optional Equipment (page 11-2)

Printer Functions

Item		Description		
Printing Speed	P-C3562DN	Black and White Printing	Full Color Printing	
		A4	35 sheets/min	35 sheets/min
		Letter	37 sheets/min	37 sheets/min
		Legal	30 sheets/min	30 sheets/min
		B5	35 sheets/min	35 sheets/min
		A5	35 sheets/min	35 sheets/min
	P-C4072DN	A4	40 sheets/min	40 sheets/min
		Letter	42 sheets/min	42 sheets/min
		Legal	34 sheets/min	34 sheets/min
		B5	40 sheets/min	40 sheets/min
		A5	40 sheets/min	40 sheets/min
		A6	40 sheets/min	40 sheets/min
First Print Time (A4, feed from Cassette)	Black and White	P-C3562DN: 6.5 seconds or less P-C4072DN: 5.5 seconds or less		
	Color	P-C3562DN: 7.5 seconds or less P-C4072DN: 6.5 seconds or less		
Resolution		600 × 600 dpi, 9600 dpi equivalent × 600 dpi, 1200 × 1200 dpi		
Operating System		Windows 7, Windows 8, Windows 8.1, Windows 10, Windows Server 2008/R2, Windows Server 2012/R2, Windows Server 2016, Mac OS 10.5 or later		
Interface		USB Interface Connector: 1 (Hi-Speed USB) Network interface: 1 (10 BASE-T/100 BASE-TX/1000 BASE-T) Optional Interface (Option): 1 (For IB-50/IB-51/IB-36 mounting)		
Page Description Language		PRESCRIBE		
Emulations		PCL6 (PCL-XL, PCL5c), KPDL3, XPS		

Paper Feeder (500-sheet) (Option)

Item	Description
Paper Supply Method	Friction roller feeder (No. Sheets: 500, 80 g/m ²)
Paper Size	A4, A5, B5, B6, Folio, 216 × 340 mm, Letter, Legal, Statement, Executive, Oficio II, 16K, B5 (ISO), Envelope #10, Envelope #9, Envelope #6 3/4, Envelope Monarch, Envelope DL, Envelope C5, Youkei 4, Youkei 2, Custom (92 × 162 to 216 × 356 mm)
Supported Paper	Paper weight: 60 to 220 g/m ² Media types: Plain, Rough, Recycled, Preprinted, Labels, Bond, Vellum, Color (Colour), Prepunched, Letterhead, Envelope, Coated, Thick, High Quality, Custom 1 to 8
Dimensions (W) × (D) × (H)	15.36" × 20.95" × 4.57" 390 × 532 × 116 mm
Weight	9.1 lbs. or less/ 4.1 kg or less

NOTE

Consult your dealer or service representative for recommended paper types.

Glossary

Accessibility

The machine is designed featuring good accessibility even for the elderly and those who are physically challenged or visually impaired.

Apple Talk

AppleTalk offers file sharing and printer sharing and it also enables you to utilize application software that is on another computer on the same AppleTalk network.

Auto Form Feed Timeout

During data transmission, the machine may sometimes have to wait until receiving the next data. This is the auto form feed timeout. When the preset timeout passes, the machine automatically prints output. However, no output is performed if the last page has no data to be printed.

Auto-IP

Auto-IP is a module that enables dynamic IPv4 addresses to be assigned to a device on startup. However, DHCP requires a DHCP server. Auto-IP is a server-less method of choosing an IP address. IP addresses between 169.254.0.0 to 169.254.255.255 are reserved for Auto-IP and assigned automatically.

Auto Paper Selection

A function to automatically select paper in the same size as originals when printing.

Auto Sleep

A mode designed for electrical power saving, activated when the machine is left unused or there is no data transfer for a specific period. In Sleep mode, power consumption is kept to a minimum.

Bonjour

Bonjour, also known as zero-configuration networking, is a service that automatically detects computers, devices and services on an IP network. Bonjour, because an industry-standard IP protocol is used, allows devices to automatically recognize each other without an IP address being specified or DNS server being set. Bonjour also sends and receives network packets by UDP port 5353. If a firewall is enabled, the user must check that UDP port 5353 is left open so that Bonjour will run correctly. Some firewalls are set up so as to reject only certain Bonjour packets. If Bonjour does not run stably, check the firewall settings and ensure that Bonjour is registered on the exceptions list and that Bonjour packets are accepted. If you install Bonjour on Windows OS, the Windows firewall will be set up correctly for Bonjour.

Custom Box

The Custom Box function stores print data for each individual user on the printer and allows the user to print single or multiple copies of the stored data later using the printer's operation panel.

Default Gateway

This indicates the device, such as a computer or router, that serves as the entrance/exit (gateway) for accessing computers outside the network that you are on. When no specific gateway is designated for a destination IP address, data is sent to the host designated as the Default Gateway.

DHCP (Dynamic Host Configuration Protocol)

Dynamic Host Configuration Protocol (DHCP) that automatically resolves IP addresses, subnet masks, and gateway addresses on a TCP/IP network. DHCP minimizes the load of network management employing a large number of client computers because it relieves individual clients including printers from the IP address being assigned.

DHCP (IPv6)

DHCP (IPv6) is the next-generation of the Internet's Dynamic Host Configuration Protocol and supports IPv6. It extends the BOOTP startup protocol that defines the protocols used for transferring configuration information to hosts on the network. DHCP (IPv6) permits the DHCP server to use its expanded functionality to send configuration parameters to an IPv6 node. Because the network addresses that can be used are allocated automatically, the IPv6 node management workload is reduced in systems where the administrator has to exercise close control over IP address allocation.

dpi (dots per inch)

A unit for resolution, representing the number of dots printed per inch (25.4 mm).

EcoPrint Mode

A printing mode that helps save toner. Copies made in this mode are thus lighter than normal.

Emulation

The function to interpret and execute other printers' page description languages. The machine emulates operation of PCL6, KPDL3 (PostScript 3 compatible).

FTP (File Transfer Protocol)

A protocol to transfer files on the TCP/IP network, whether the Internet or an intranet. Along with HTTP and SMTP/POP, FTP is now frequently used on the Internet.

Grayscale

A computer color expression. Displayed images of this sort are typically composed of shades of gray, varying from black at the weakest intensity to white at the strongest, without any other colors. Gray levels are displayed in numerical levels: that is, white and black only for 1 bit; 256 gray levels (including white and black) for 8 bits; and 65,536 gray levels for 16 bits.

IP Address

An Internet protocol address is a unique number that represents a specific computer or related device on the network. The format of an IP address is four sets of numbers separated by dots, e.g. 192.168.110.171. Each number should be between 0 and 255.

IPP

IPP (Internet Printing Protocol) is a standard that uses TCP/IP networks such as the Internet to enable print jobs to be sent between remote computers and printers. IPP is an extension of the HTTP protocol used to view websites and enables printing to be carried out via routers on printers in remote locations. It also supports the HTTP authentication mechanisms along with SSL server and client authentication as well as encryption.

Job Box

The Job Box function stores print data on the printer and allows users to print single or multiple copies of the stored data later using the printer's operation panel.

KPDL (Kyocera Page Description Language)

Kyocera's PostScript page description language compatible with Adobe PostScript Level 3.

Multi Purpose (MP) Tray

The paper supply tray on the front side of the machine. Use this tray instead of the cassettes when printing onto envelopes, Hagaki (Cardstock), transparencies, or labels.

NetBEUI (NetBIOS Extended User Interface)

An interface, developed by IBM in 1985, as an update from NetBIOS. It enables more advanced functions on smaller networks than other protocols such as TCP/IP, etc. It is not suitable for larger networks due to lack of routing capabilities to choose the most appropriate routes. NetBEUI has been adopted by IBM for its OS/2 and Microsoft for its Windows as a standard protocol for file sharing and printing services.

Outline font

With outline fonts, character outlines are represented with numerical expressions and fonts can be enlarged or reduced in different ways by changing the numeric values of those expressions. Printing remains clear even if you enlarge fonts, since the characters are defined with outlines represented with numerical expressions. You can specify the font size in steps of 0.25 points up to 999.75 points.

PDF/A

This is "ISO 19005-1. Document management - Electronic document file format for long-term preservation - Part 1: Use of PDF (PDF/A)", and is a file format based on PDF 1.4. It has been standardized as ISO 19005-1, and is a specialization of PDF, which has been mainly used for printing, for long-term storage. A new part, ISO 19005-2 (PDF/A-2), is currently being prepared.

POP3 (Post Office Protocol 3)

A standard protocol to receive E-mail from the server in which the mail is stored on the Internet or an intranet.

PostScript

A page description language developed by Adobe Systems. It enables flexible font functions and highly-functional graphics, allowing higher quality printing. The first version called Level 1 was launched in 1985, followed by Level 2 that enabled color printing and two-byte languages (e.g. Japanese) in 1990. In 1996, Level 3 was released as an update for the Internet access and PDF format as well as gradual improvements in implementation technologies.

PPM (prints per minute)

This indicates the number of A4 size printouts made in one minute.

Printer Driver

The software to enable you to print data created on any application software. The printer driver for the machine is contained in the DVD enclosed in the package. Install the printer driver on the computer connected to the machine.

RA(Stateless)

The IPv6 router communicates (transmits) information such as the global address prefix using ICMPv6. This information is the Router Advertisement (RA).

ICMPv6 stands for Internet Control Message Protocol, and is a IPv6 standard defined in the RFC 2463 "Internet Control Message Protocol (ICMPv6) for the Internet Protocol Version 6 (IPv6) Specification".

RAM Disk

Using part of the printer's memory as a virtual disk, you can set any amount of memory from overall printer memory as a RAM disk in order to use features such as electronic sorting (shortening print time).

SMTP (Simple Mail Transfer Protocol)

A protocol for E-mail transmission over the Internet or an intranet. It is used for transferring mail between mail servers as well as for sending mail from clients to their servers.

Status Page

The page lists machine conditions.

Subnet Mask

The subnet mask is a way of augmenting the network address section of an IP address.

A subnet mask represents all network address sections as 1 and all host address sections as 0. The number of bits in the prefix indicates the length of the network address. The term "prefix" refers to something added to the beginning and, in this context, indicates the first section of the IP address. When an IP address is written, the length of the network address is indicated by the prefix length after a forward slash (/). For example, "24" in the address "133.210.2.0/24". In this way, "133.210.2.0/24" denotes the IP address "133.210.2.0" with a 24-bit prefix (network section). This new network address section (originally part of the host address) made possible by the subnet mask is referred to as the subnet address. When you enter the subnet mask, be sure to set the "DHCP" setting to "Off".

TCP/IP (Transmission Control Protocol/Internet Protocol)

TCP/IP is a suite of protocols designed to define the way computers and other devices communicate with each other over a network.

TCP/IP (IPv6)

TCP/IP (IPv6) is based on the current Internet protocol, TCP/IP (IPv4). IPv6 is the next-generation Internet protocol and expands the available address space, which resolves the problem of the lack of addresses under IPv4, while also introducing other improvements such as additional security functionality and the capacity to prioritize data transmission.

TWAIN (Technology Without An Interesting Name)

A technical specification for connecting scanners, digital cameras, and other image equipment to computers. The TWAIN compatible devices enable you to process image data on any relevant application software. TWAIN is adopted on a large amount of graphic software (e.g. Adobe Photoshop) and OCR software.

USB (Universal Serial Bus) 2.0

A USB interface standard for Hi-Speed USB 2.0. The maximum transfer rate is 480 Mbps. This machine is equipped with USB 2.0 for high-speed data transfer.

WIA (Windows Imaging Acquisition)

A function to import images supported after Windows Me/XP from digital cameras and other peripheral devices. This function replaces what TWAIN used to do. The feature is provided as a part of Windows functions and improves ease of operation, so that you import images directly to My Computer without using any application.

Index

A

- Accessibility 11-25
- Adjustment/Maintenance 8-34
- AirPrint 4-7
- Anti-theft Lock Slot 2-2
- Apple Talk 11-25
- Auto Error Clear 8-29
- Auto Form Feed Timeout 11-25
- Auto Panel Reset 8-28
- Auto Paper Selection 11-25
- Auto Sleep 2-24, 11-25
- Auto-IP 11-25
 - Settings 8-14
- Automatic 2-Sided Print Function 1-12

B

- Bluetooth Set. 8-30
- Bonjour 11-25
 - Protocol Settings 8-16
- Buzzer 8-26

C

- Cables 2-6
- Card Authentication Kit 11-3
- Cassette
 - Loading Paper 3-4
 - Paper Size and Media Type 3-10, 8-8
- Cassette 1 2-2
- Cassette Settings 3-10
- Cassettes 2 to 4 2-5
- Character Entry Method 11-10
- Checking the Counter 2-36
- Checking the Remaining Amount of Toner 7-6
- Cleaning 10-2
 - Paper Transfer Unit 10-2
- Coated Paper 11-21
- Color Regist. 8-34
- ColorCalibration 8-34
- Connecting
 - LAN Cable 2-7
 - Power Cable 2-8
 - USB cable 2-8
- Connection Method 2-6
- Conventions Used in This Guide xi
- Counting the Number of Pages Printed
 - Counter 2-36
 - Each Job Account 9-24
 - Print Accounting Report 9-25
 - Unknown ID Job 9-27
- Custom Box 11-25
 - Creating a New Box 5-5
 - Deleting Documents 5-10
 - Editing and Deleting Custom Box 5-7
 - Editing Documents 5-9
 - Printing Documents 5-8
 - Storing Documents 5-7

D

- Data Security 8-32
- Data Security Kit 11-7
- Date 8-25
- Date Format 8-25
- Date Setting
 - Date 8-25
 - Date Format 8-25
 - Summer Time 8-25
 - Time 8-25
 - Time Zone 8-25
- Def. Screen(Box) 8-25
- Default Gateway 11-25
 - Settings 8-14
- Del. after Print 6-5
- Device 7-5
- Device Common 8-25
 - Bluetooth Set 8-30
 - Buzzer 8-26
 - ColorToner Empty 8-27
 - Date Setting 8-25
 - Def. Screen(Box) 8-25
 - Display Brightness 8-27
 - Display Status/Log 8-30
 - Error Handling 8-27
 - Format SD Card 8-27
 - Format SSD 8-26
 - Language 8-25
 - Low Toner Alert 8-30
 - RAM Disk Setting 8-26
 - Timer Setting 8-28
 - USB Keyboard Type 8-30
- DHCP 11-26
 - Settings 8-14
- DHCP (IPv6) 11-26
 - Settings 8-15
- Display Brightness 8-27
- Display Status/Log 8-30
- Document Box
 - Custom Box 5-3, 5-5
 - Job Box 4-8, 5-3
 - Removable Memory Box 5-4
 - What is Document Box? 5-3
- Document Processor
 - Part Names 2-2
- dpi 11-26
- Duplex 6-4

E

- EcoPrint 6-4, 11-26
- E-mail Settings 2-44
- Embedded Web Server RX 2-38
- Emulation 11-26
- Encrypted PDF 6-5
- Energy Saving Control Function 1-12
- Energy Star (ENERGY STAR®) Program 1-12
- Enhanced WSD
 - Protocol Settings 8-20
- EnhancedWSD(SSL)
 - Protocol Settings 8-20

-
- Entry
 - File Name [6-5](#)
 - Environment [1-3](#)
 - Err. Clear Timer [8-29](#)
 - Error Handling [8-27](#)
 - Expansion Memory [11-4](#)
 - F**
 - Feed Cover [2-3](#)
 - File Name Entry [6-5](#)
 - First Print Time [11-24](#)
 - FTP [11-26](#)
 - FTP(Server)
 - Protocol Settings [8-17](#)
 - Fuser Cover [2-3](#)
 - G**
 - Glossary [11-25](#)
 - Google Cloud Print [4-7](#)
 - GPL/LGPL [1-9](#)
 - Grayscale [11-26](#)
 - Group Authorization Set.
 - Group Authorization [9-10](#)
 - Guides Provided with the Machine [viii](#)
 - H**
 - Handles [2-2](#)
 - Help [11-26](#)
 - Help Screen [2-12](#)
 - Host Name [8-12](#)
 - HTTP
 - Protocol Settings [8-18](#)
 - HTTPS
 - Protocol Settings [8-19](#)
 - I**
 - I/F Block Set. [8-31](#)
 - Install
 - Macintosh [2-34](#)
 - Software [2-26](#)
 - Uninstalling [2-33](#)
 - Windows [2-27](#)
 - IP Address [11-26](#)
 - Settings [8-14](#)
 - IP Filter (IPv4)
 - Protocol Settings [8-16](#)
 - IP Filter (IPv6)
 - Protocol Settings [8-16](#)
 - IPP [11-26](#)
 - Protocol Settings [8-18](#)
 - IPP Over SSL
 - Protocol Settings [8-18](#)
 - IPSec
 - Protocol Settings [8-16](#)
 - J**
 - Job
 - Checking History [7-3](#)
 - Checking Status [7-2](#)
 - Displaying History Screen [7-3](#)
 - Displaying Status Screens [7-2](#)
 - Sending the Log History [7-4](#)
 - Job Accounting [9-14](#)
 - Adding an Account [9-17](#)
 - Apply Limit [9-23](#)
 - Counting the Number of Pages Printed [9-24](#)
 - Deleting an Account [9-20](#)
 - Editing an Account [9-19](#)
 - Enabling Job Accounting [9-15](#)
 - Job Accounting Access [9-16](#)
 - Login [9-26](#)
 - Logout [9-26](#)
 - Overview of Job Accounting [9-14](#)
 - Print Accounting Report [9-25](#)
 - Printing [9-21](#)
 - Restricting the Use of the Machine [9-18](#)
 - Job Box [11-26](#)
 - Deletion of Job Retention [4-17](#)
 - Private Print Box [4-9](#)
 - Proof and Hold Box [4-15](#)
 - Quick Copy Box [4-13](#)
 - Quick Copy Job Retention [4-17](#)
 - Specifying the Job Box from a Computer and Storing the Job [4-8](#)
 - Storage Media [4-17](#)
 - Stored Job Box [4-11](#)
 - Job Finish Notice [6-4](#)
 - K**
 - KPDL [11-27](#)
 - L**
 - Label [11-19](#)
 - LAN Cable [2-6](#)
 - Connecting [2-7](#)
 - Language [8-25](#)
 - LDAP
 - Protocol Settings [8-19](#)
 - Legal Information [1-8](#)
 - Limited Use of This Product [1-7](#)
 - Login [2-13](#)
 - Logout [2-14](#)
 - Low Toner Alert [8-30](#)
 - LPD
 - Protocol Settings [8-17](#)
 - M**
 - Management [9-1](#)
 - Manual Settings (IPv6) [8-15](#)
 - Media Type Setting [8-9](#)
 - Monotype Imaging License Agreement [1-10](#)
 - Mopria [4-7](#)
 - Multi Purpose Tray [2-3, 11-27](#)
 - Paper Size and Media Type [3-12, 8-7](#)

N

- NetBEUI 11-27
 - Protocol Settings 8-16
- Network
 - Ping 8-21
 - Preparation 2-24
 - Primary Network 8-21
 - Restart Network 8-22
 - Settings 8-12
- Network Interface 2-6
- Network Interface Connector 2-3
- Network Interface Kit 11-5
- Network Settings
 - Configuring the Wired Network 2-16
 - Configuring the Wireless Network 2-18
 - Wi-Fi Direct Set 2-22
- Notice 1-2

O

- Op Functions 8-34
- OpenSSL License 1-9
- Operation Panel 2-2
- Option
 - Card Authentication Kit 11-3
 - Data Security Kit 11-7
 - Expansion Memory 11-4
 - Network Interface Kit 11-5
 - Overview 11-2
 - Paper Feeder 11-3
 - SD Card 11-6
 - SSD 11-5
 - ThinPrint Option 11-7
 - USB Keyboard 11-7
 - Wireless Network Interface Kit 11-5
- Option Interface 2-3
- Optional Applications 11-8
- Optional Network 8-22
 - Basic 8-24
 - Wireless Network 8-22
- Original SSLeay License 1-9
- Outline font 11-27

P

- PanelReset Timer 8-28
- Paper
 - Checking the Remaining Amount of Paper 7-6
 - Appropriate Paper 11-15
 - Cassette 8-8
 - Loading Cardstock 3-9
 - Loading Envelopes 3-9
 - Loading Paper 3-2
 - Loading Paper in the Cassettes 3-4
 - Loading Paper in the Multi Purpose Tray 3-7
 - Multi Purpose Tray 8-7
 - Precaution for Loading Paper 3-3
 - Size and Media Type 3-10, 11-14
 - Special Paper 11-18
 - Specifications 11-14
 - Weight 8-9
- Paper Feeder 11-3

- Paper Jams 10-25
 - Cassettes 1 to 4 10-28
 - Duplex Unit 10-35
 - Inside the Machine 10-33
 - Jam Location Indicators 10-25
 - Multi Purpose Tray 10-26
 - Rear Cover 1 10-33
 - Rear Cover 1 (Feed) 10-29
 - Rear Cover 2 10-30
 - Rear Cover 3 10-32
- Paper Length Guide 2-3, 3-5
- Paper Settings 8-7
 - Cassette 1 (to 4) Set. 8-7
 - Media Type Set. 8-7
 - MP Tray Set. 8-7
 - Reset Type Adj. 8-7
- Paper Stopper 2-2, 3-13
- Paper Width Guides 2-3, 3-4
- Part Names 2-2
- PDF/A 11-27
- Ping 8-21
- POP3 11-27
 - Protocol Settings 8-17
- PostScript 11-27
- Power Cable
 - Connecting 2-8
- Power Management 1-12
- Power Off 2-9
- Power Off Rule 8-29
- Power Off Timer 8-29
- Power On 2-9
- Power Switch 2-2
- PPM 11-27
- Precaution for Loading Paper 3-3
- Precautions for Use 1-4
- Primary Network 8-21
- Print Settings 4-5, 8-10
 - Auto Cass.Change 8-10
 - Color Mode 8-10
 - Duplex 8-10
 - Emulation Set. 8-10
 - Job Name 8-12
 - Job Terminator 8-12
 - MP Tray Priority 8-10
 - Override A4/LTR 8-10
 - Page Setting 8-11
 - Paper Feed Mode 8-10
 - Paper Source 8-10
 - Print Quality 8-11
 - User Name 8-11
- Printer
 - Print setting 4-5
- Printer Driver 11-27
 - Help 4-6
- Printing Documents Stored in Removable USB Memory 5-11
- Printing from PC 4-2
- Printing Speed 11-24
- Product Library ix

Q

Quiet Mode [6-5, 8-34](#)

R

RA(Stateless) [11-27](#)

Settings [8-15](#)

RAM Disk [11-28](#)

RAM Disk Setting [8-26](#)

RAW Port

Protocol Settings [8-17](#)

Rear Cover 1 [2-2](#)

Rear Cover 2 to 4 [2-5](#)

Recycled Paper [11-21](#)

Regarding Trade Names [1-8](#)

Regular Maintenance [10-2](#)

Toner Container Replacement [10-3](#)

Waste Toner Box Replacement [10-7](#)

Report [8-5](#)

Job Log History [8-6](#)

Report Print [8-5](#)

Report Print

Config. List [8-5](#)

DataSanitization [8-6](#)

Font List [8-6](#)

Menu Map [8-5](#)

RAM File List [8-6](#)

SD Card FileList [8-6](#)

SSD File List [8-6](#)

Status Page [8-5](#)

Resolution [11-24](#)

Resource Saving - Paper [1-12](#)

Responding to Messages [10-13](#)

REST

Protocol Settings [8-20](#)

REST over SSL

Protocol Settings [8-21](#)

Restart [8-34](#)

Restart Network [8-22](#)

S

Safety Conventions in This Guide [1-2](#)

SD Card [11-6](#)

Format [8-27](#)

Security [8-31](#)

Data Security [8-32](#)

I/F Block Set. [8-31](#)

Security Level [8-31](#)

Security Level [8-31](#)

Security Precautions when Using Wireless LAN [1-6](#)

Service Setting [8-34](#)

Setting Date and Time [2-15](#)

Simple Login [2-13](#)

Size Dial [2-3](#)

Sleep Level [2-25](#)

Sleep Level Set. [8-28](#)

Sleep Timer [8-28](#)

SMTP [11-28](#)

Protocol Settings [8-17](#)

SNMP

Protocol Settings [8-17](#)

SNMPv3

Protocol Settings [8-16](#)

Solving Malfunctions [10-9](#)

Specifications [11-22](#)

Machine [11-22](#)

Paper Feeder (500-sheet) (Option) [11-24](#)

Printer Functions [11-24](#)

SSD [11-5](#)

Format [8-26](#)

SSD Initializ. [8-32](#)

Status Page [11-28](#)

Status/Job Cancel [7-1](#)

Subnet Mask [11-28](#)

Settings [8-14](#)

Supplies

Checking the Remaining Amount [7-6](#)

Symbols [1-2](#)

System Menu [8-2](#)

Adjustment/Maintenance [8-34](#)

Device Common [8-25](#)

Network [8-12](#)

Op Functions [8-34](#)

Optional Network [8-31](#)

Paper Settings [8-7](#)

Print Settings [8-10](#)

Report [8-5](#)

Security [8-31](#)

User Login/Job Accounting [8-33](#)

T

TCP/IP [11-28](#)

Settings [8-14, 8-15](#)

TCP/IP (IPv4)

Settings [2-16, 8-14](#)

TCP/IP (IPv6) [11-26](#)

Settings [8-15](#)

Thinprint

Protocol Settings [8-19](#)

ThinPrint Option [11-7](#)

ThinPrintOverSSL

Protocol Settings [8-19](#)

TIFF/JPEG Size [6-6](#)

Default [8-11](#)

Time [8-25](#)

Time Zone [8-25](#)

Timer Setting

Auto Error Clear [8-29](#)

Auto Panel Reset [8-28](#)

Err. Clear Timer [8-29](#)

FormFeed Timeout [8-30](#)

PanelReset Timer [8-28](#)

Ping Timeout [8-30](#)

Power Off Rule [8-29](#)

Power Off Timer [8-29](#)

Sleep Level Set. [8-28](#)

Sleep Timer [8-28](#)

WeeklyTimer Set. [8-29](#)

Toner Container (Black) [2-4](#)

Toner Container (Cyan) [2-4](#)

Toner Container (Magenta) [2-4](#)

- Toner Container (Yellow) [2-4](#)
- Toner Container Lock Lever [2-4](#)
- Toner Container Replacement [10-3](#)
- Top Tray [2-2](#)
- Troubleshooting [10-9](#)
- TWAIN [11-28](#)

U

- USB [11-28](#)
- USB Cable
 - Connecting [2-8](#)
- USB Interface [2-6](#)
- USB Interface Connector [2-3](#)
- USB Keyboard [11-7](#)
- USB Keyboard Type [8-30](#)
- USB Memory
 - Printing [5-11](#)
 - Remove [5-13](#)
- USB Memory Slot [2-2](#)
- USB Port [2-3](#)
- User Login Administration [9-2](#)
 - Adding a User [9-5](#)
 - Changing User Properties [9-6](#)
 - Enabling User Login Administration [9-3](#)
 - ID Card Settings [9-11](#)
 - Login [2-13](#)
 - Logout [2-14](#)
 - Obtain NW User Property [9-10](#)
 - Overview of User Login Administration [9-2](#)
 - Printing [9-8](#)
- User Login/Job Accounting [8-33](#)
 - Job Accounting [9-14](#)
 - Unknown ID Job [9-27](#)
 - User Login [9-2](#)

W

- Waste Toner Box [2-4](#)
- Waste Toner Box Replacement [10-7](#)
- Waste Toner Cover [2-4](#)
- WeeklyTimer Set. [8-29](#)
- WIA [11-28](#)
- Wi-Fi
 - Settings [2-18](#), [8-13](#)
- Wi-Fi Direct
 - Printing [4-7](#)
 - Settings [2-22](#)
- Wi-Fi Direct Set [8-12](#)
- Wireless Connection [1-5](#)
- Wireless Network
 - Settings [2-18](#)
- Wireless Network Interface Kit [11-5](#)
- WSD-PRINT
 - Protocol Settings [8-19](#)

X

- XPS FitTo Page [6-6](#)

**QUALITY
CERTIFICATE**

This machine has passed
all quality controls and
final inspection.

